

### 特性

- 低功耗
- 低压降
- 较低的温度系数
- 高输入电压 (高达 30V)
- 输出电压精度:  $\pm 2\%$
- 过流保护
- 过温保护
- 芯片使能 / 除能功能
- 封装类型: 3-pin SOT89, 5-pin SOT23

### 应用领域

- 电池供电设备
- 通信设备
- 音频 / 视频设备

### 概述

HT75xx-7 系列是一组 CMOS 技术实现的低功耗高电压稳压器。CMOS 技术可确保其具有低压降和低静态电流的特性。输入电压可高达 30V, 且具有几个固定的输出电压, 范围从 2.1V 到 12.0V。

当 CE 输入脚为低, 快速放电通道可通过一个内置的下拉电阻将输出电压拉低。即使输出脚短接到地, 内建的过流保护电路也可避免芯片受到损害。过温保护电路确保芯片结温将不超过 160°C。

### 选型表

型号	输出电压	封装	正印
HT7521-7	2.1V	SOT89 SOT23-5	75xx-7 (封装为 SOT89) 5xx7 (封装为 SOT23-5)
HT7523-7	2.3V		
HT7525-7	2.5V		
HT7527-7	2.7V		
HT7530-7	3.0V		
HT7533-7	3.3V		
HT7536-7	3.6V		
HT7540-7	4.0V		
HT7544-7	4.4V		
HT7550-7	5.0V		
HT7560-7	6.0V		
HT7570-7	7.0V		
HT7580-7	8.0V		
HT7590-7	9.0V		
HT75A0-7	10.0V		
HT75C0-7	12.0V		

注: “xx” 代表输出电压。

方框图

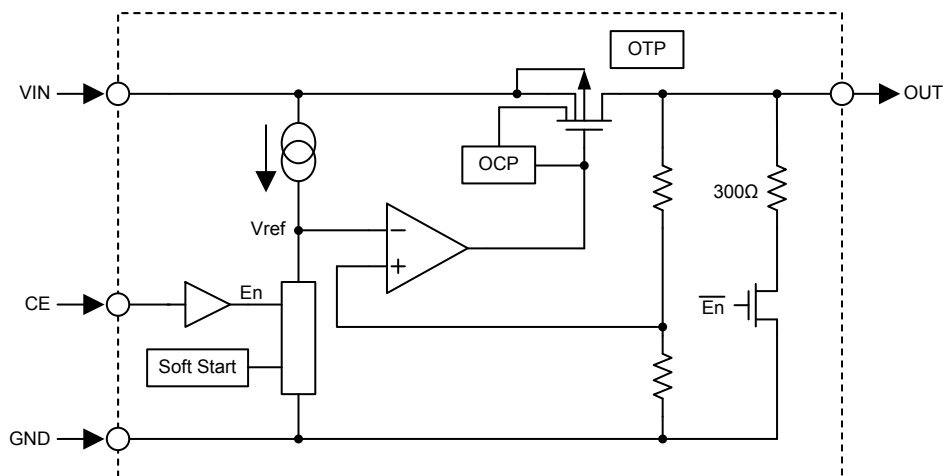

引脚图

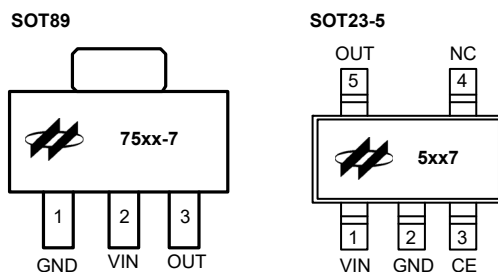

引脚说明

型号		引脚名称	引脚说明
SOT89	SOT23-5		
1	2	GND	地
2	1	VIN	输入脚
3	5	OUT	输出脚
—	3	CE	芯片使能引脚, 高电平使能
—	4	NC	未连接

## 极限参数

参数	值	单位	
$V_{IN}$	-0.3 ~ +33	V	
$V_{CE}$	-0.3 ~ ( $V_{IN}+0.3$ )	V	
工作温度范围, $T_a$	-40 ~ +85	°C	
最大结温, $T_{J(MAX)}$	+150	°C	
储存温度范围	-65 ~ +165	°C	
结至环境的热阻, $\theta_{JA}$	SOT89	200	°C/W
	SOT23-5	500	°C/W
功耗, $P_D$	SOT89	0.50	W
	SOT23-5	0.20	W

注:  $P_D$  值是在  $T_a = 25^\circ\text{C}$  时测得。

## 建议工作条件

参数	值	单位
$V_{IN}$	3.1 ~ 30	V
$V_{CE}$	0 ~ $V_{IN}$	V

## 电气特性

$V_{IN}=V_{OUT}+2V$ ,  $V_{CE}=V_{IN}$ ,  $T_a=+25^\circ\text{C}$ ,  $C_{IN}=C_{OUT}=10\mu\text{F}$ , 除非另外说明

符号	参数	测试条件	最小	典型	最大	单位	
$V_{IN}$	输入电压	—	—	—	30	V	
$V_{OUT}$	输出电压	—	2.1	—	12.0	V	
$V_O$	输出电压精度	$I_{OUT}=10\text{mA}$	-2	—	2	%	
$I_{OUT}$	输出电流	$V_{OUT} < 5.0\text{V}$	100	—	—	mA	
		$V_{OUT} \geq 5.0\text{V}$	150	—	—		
$\Delta V_{OUT}$	负载调节	$1\text{mA} \leq I_{OUT} \leq 50\text{mA}$	—	15	45	mV	
$V_{DIF}$	压差	$I_{OUT}=1\text{mA}$ , $V_{OUT}$ 下降 2% (注)	—	10	30	mV	
$I_{SS1}$	静态电流	$I_{OUT}=0\text{mA}$	—	2.5	4.0	$\mu\text{A}$	
$I_{SS2}$		$V_{CE}=2.0\text{V}$ , $V_{IN}=30\text{V}$ , $I_{OUT}=0\text{mA}$	—	3.0	5.0		
$I_{SHD}$	关机电流	$V_{CE}=0\text{V}$	—	0.1	0.5	$\mu\text{A}$	
$\frac{\Delta V_{OUT}}{\Delta V_{IN} \times \Delta V_{OUT}}$	线性调整率	$(V_{OUT}+1\text{V}) \leq V_{IN} \leq 30\text{V}$ , $I_{OUT}=1\text{mA}$	$V_{OUT} \leq 5\text{V}$	—	0.1	0.2	%/V
			$V_{OUT} \geq 6\text{V}$	—	0.2	0.4	%/V
$\frac{\Delta V_{OUT}}{\Delta T_a \times \Delta V_{OUT}}$	温度系数	$I_{OUT}=10\text{mA}$ , $-40^\circ\text{C} < T_a < 85^\circ\text{C}$	—	$\pm 100$	—	ppm/°C	
$I_{SHORT}$	短路输出电流	$V_{IN}=12\text{V}$ , $V_{OUT}=0\text{V}$	—	150	—	mA	
$T_{SHD}$	关机温度	—	—	160	—	°C	
$T_{REC}$	恢复温度	—	—	125	—	°C	
$V_{IH}$	使能电平高阈值	CE 脚, $V_{OUT}+1\text{V} \leq V_{IN} \leq 30\text{V}$	2.0	—	—	V	
$V_{IL}$	使能电平低阈值	CE 脚, $V_{OUT}+1\text{V} \leq V_{IN} \leq 30\text{V}$	—	—	0.6	V	
$R_{DIS}$	放电电阻	CE=0V, 可通过 $V_{OUT}$ 测得	—	300	—	$\Omega$	

注: 在  $V_{IN}=V_{OUT}+2V$  与一个固定负载条件下使输出电压下降 2%, 此时的输入电压减去输出电压就是电压差。

### 典型性能特性

此规格测试条件为： $V_{IN}=V_{OUT}+2V$ ,  $V_{CE}=V_{IN}$ ,  $I_{OUT}=10mA$ ,  $C_{IN}=10\mu F$ ,  $C_{OUT}=10\mu F$ ,  $T_a=25^\circ C$ , 除非另有说明。

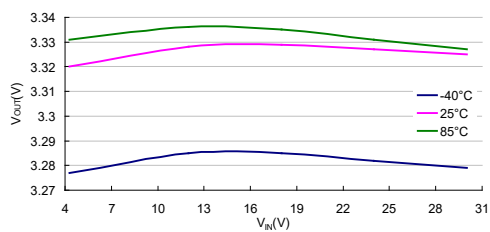

线性调整率: HT7533-7 ( $I_{OUT}=10mA$ )

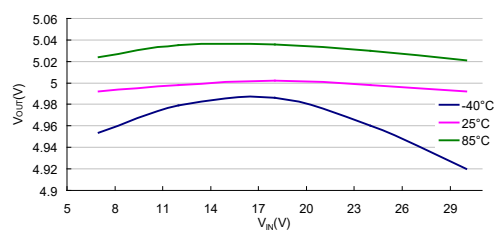

线性调整率: HT7550-7 ( $I_{OUT}=10mA$ )

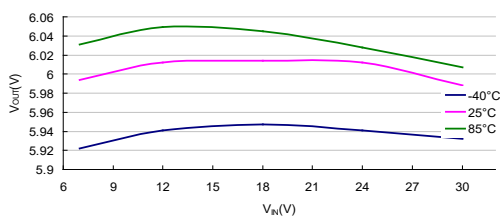

线性调整率: HT7560-7 ( $I_{OUT}=10mA$ )

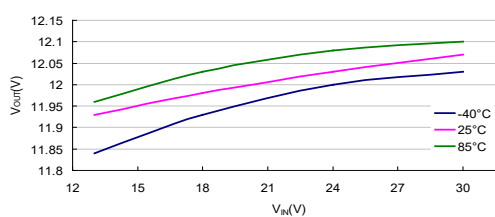

线性调整率: HT75C0-7 ( $I_{OUT}=10mA$ )

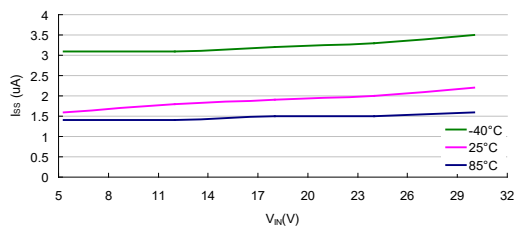

$I_{SS}$  vs  $V_{IN}$ : HT7533-7 ( $I_{OUT}=0mA$ )

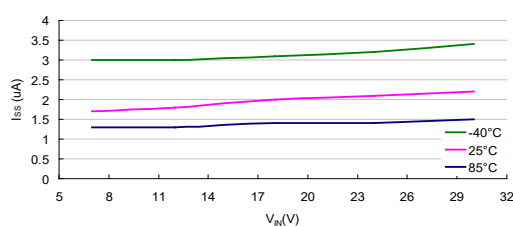

$I_{SS}$  vs  $V_{IN}$ : HT7550-7 ( $I_{OUT}=0mA$ )

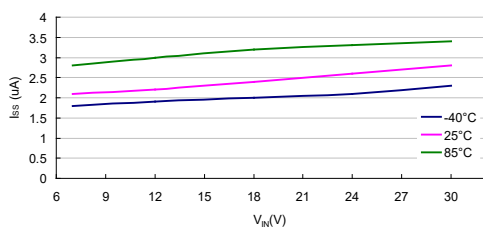

$I_{SS}$  vs  $V_{IN}$ : HT7560-7 ( $I_{OUT}=0mA$ )

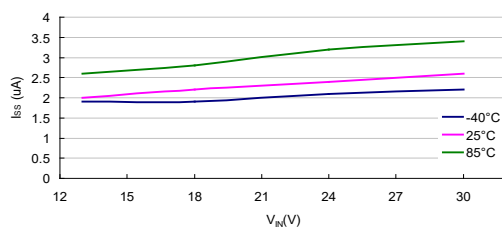

$I_{SS}$  vs  $V_{IN}$ : HT75C0-7 ( $I_{OUT}=0mA$ )

此规格测试条件为： $V_{IN}=V_{OUT}+2V$ ,  $V_{CE}=V_{IN}$ ,  $I_{OUT}=10mA$ ,  $C_{IN}=10\mu F$ ,  $C_{OUT}=10\mu F$ ,  $T_a=25^\circ C$ , 除非另有说明。

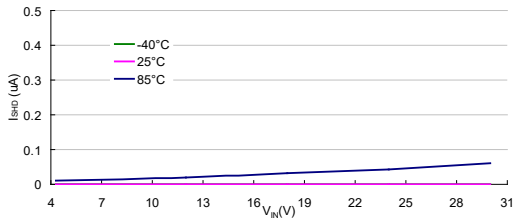

**I<sub>SHD</sub> vs V<sub>IN</sub>: HT7533-7 (I<sub>OUT</sub>=0mA)**

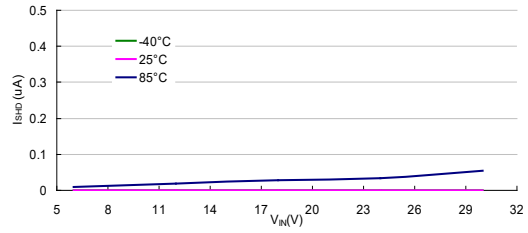

**I<sub>SHD</sub> vs V<sub>IN</sub>: HT7533-7 (I<sub>OUT</sub>=0mA)**

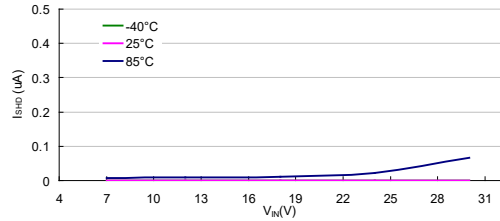

**I<sub>SHD</sub> vs V<sub>IN</sub>: HT7560-7 (I<sub>OUT</sub>=0mA)**

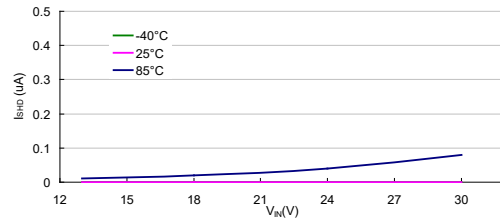

**I<sub>SHD</sub> vs V<sub>IN</sub>: HT75C0-7 (I<sub>OUT</sub>=0mA)**

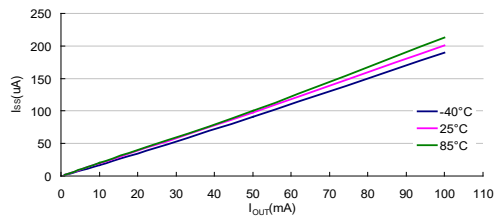

**I<sub>SS</sub> vs I<sub>OUT</sub>: HT7533-7 (V<sub>IN</sub>=5.3V)**

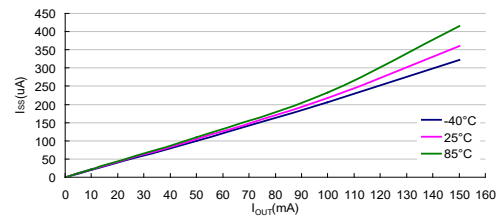

**I<sub>SS</sub> vs I<sub>OUT</sub>: HT7550-7 (V<sub>IN</sub>=7.0V)**

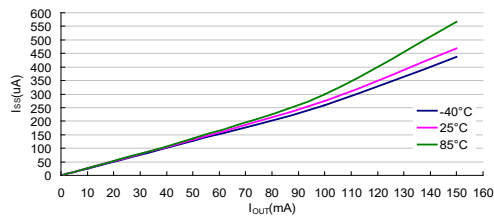

**I<sub>SS</sub> vs I<sub>OUT</sub>: HT7560-7 (V<sub>IN</sub>=8.0V)**

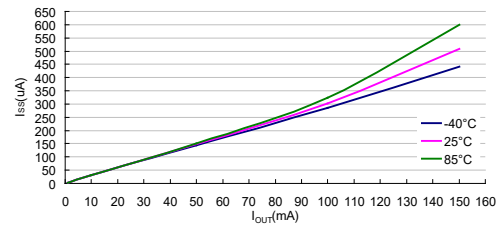

**I<sub>SS</sub> vs I<sub>OUT</sub>: HT75C0-7 (V<sub>IN</sub>=14V)**

此规格测试条件为： $V_{IN}=V_{OUT}+2V$ ,  $V_{CE}=V_{IN}$ ,  $I_{OUT}=10mA$ ,  $C_{IN}=10\mu F$ ,  $C_{OUT}=10\mu F$ ,  $T_a=25^\circ C$ ，除非另有说明。

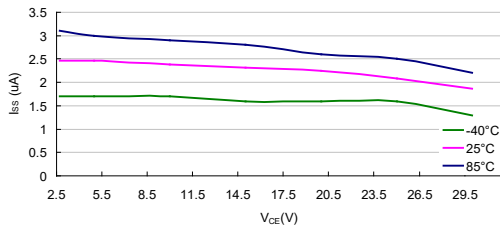

I<sub>SS</sub> vs V<sub>CE</sub>: HT7533-7 (I<sub>OUT</sub>=0mA)

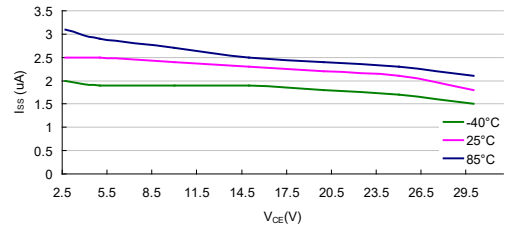

I<sub>SS</sub> vs V<sub>CE</sub>: HT7550-7 (I<sub>OUT</sub>=0mA)

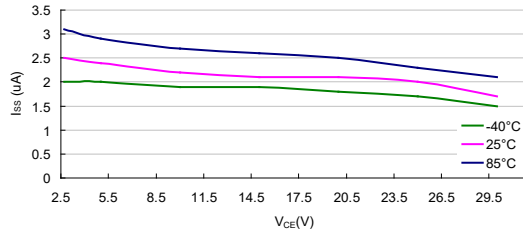

I<sub>SS</sub> vs V<sub>CE</sub>: HT7560-7 (I<sub>OUT</sub>=0mA)

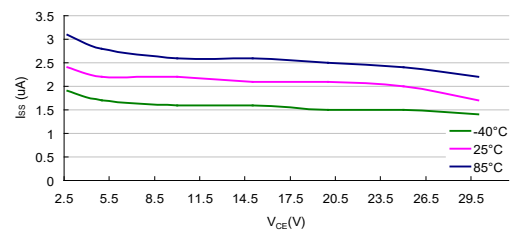

I<sub>SS</sub> vs V<sub>CE</sub>: HT75C0-7 (I<sub>OUT</sub>=0mA)

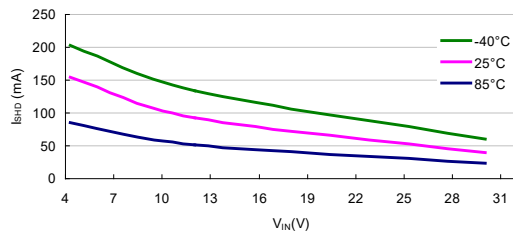

I<sub>SHD</sub> vs V<sub>IN</sub>

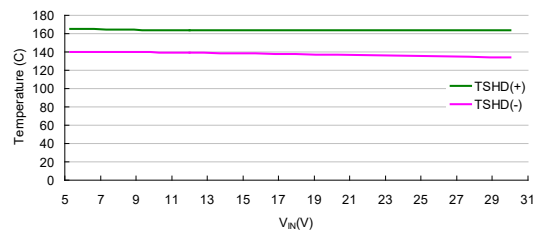

T<sub>SHD</sub> vs V<sub>IN</sub>

此规格测试条件为： $V_{IN}=V_{OUT}+2V$ ,  $V_{CE}=V_{IN}$ ,  $I_{OUT}=10mA$ ,  $C_{IN}=10\mu F$ ,  $C_{OUT}=10\mu F$ ,  $T_a=25^\circ C$ ，除非另有说明。

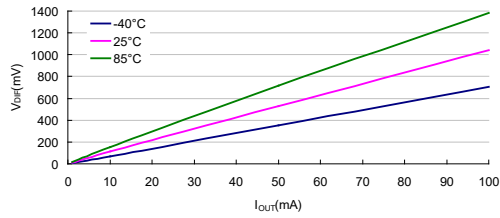

压差: HT7533-7

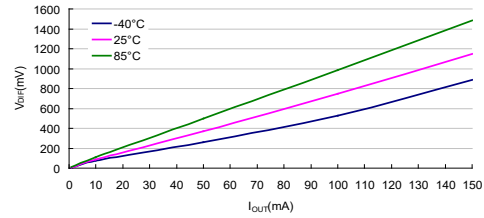

压差: HT7550-7

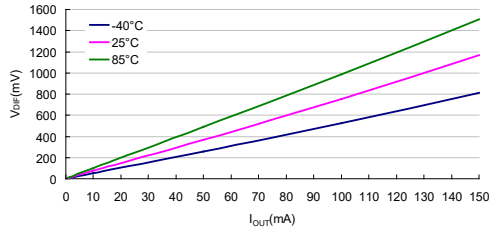

压差: HT7560-7

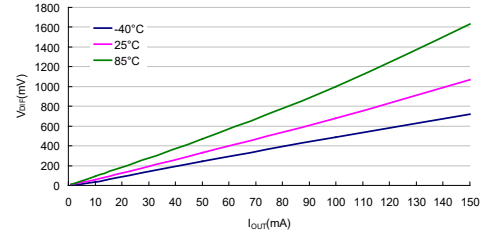

压差: HT75C0-7

此规格测试条件为： $V_{IN}=V_{OUT}+2V$ ,  $V_{CE}=V_{IN}$ ,  $I_{OUT}=10mA$ ,  $C_{IN}=10\mu F$ ,  $C_{OUT}=10\mu F$ ,  $T_a=25^{\circ}C$ , 除非另有说明。

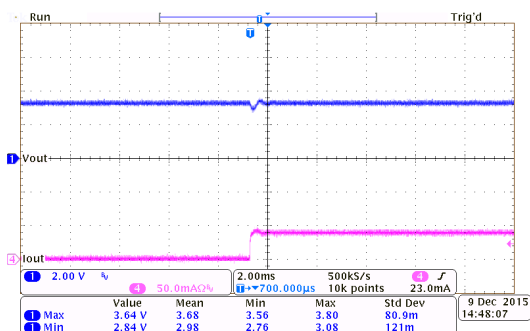

负载瞬态响应：  
HT7533-7 ( $V_{IN}=5.3V$ ,  $I_{OUT}=0mA$  to  $40mA$ )

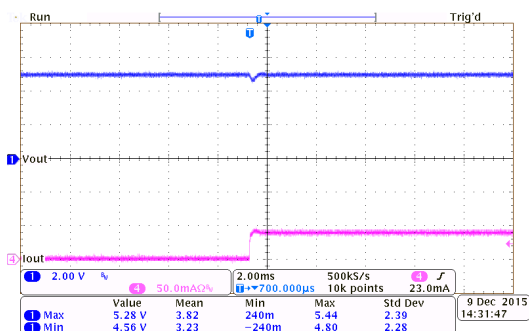

负载瞬态响应：  
HT7550-7 ( $V_{IN}=7V$ ,  $I_{OUT}=0mA$  to  $40mA$ )

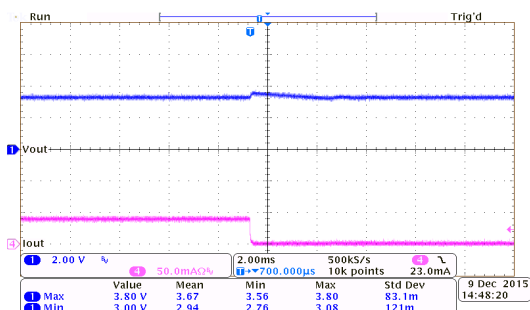

负载瞬态响应：  
HT7533-7 ( $V_{IN}=5.3V$ ,  $I_{OUT}=40mA$  to  $0mA$ )

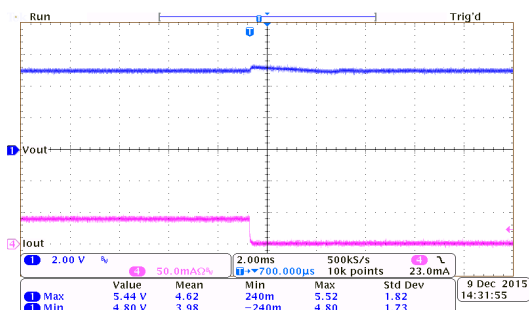

负载瞬态响应：  
HT7550-7 ( $V_{IN}=7.0V$ ,  $I_{OUT}=40mA$  to  $0mA$ )

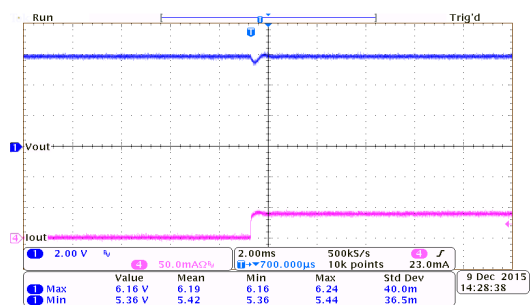

负载瞬态响应：  
HT7560-7 ( $V_{IN}=8.0V$ ,  $I_{OUT}=0mA$  to  $40mA$ )

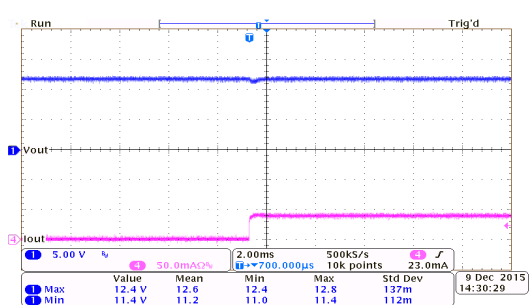

负载瞬态响应：  
HT75C0-7 ( $V_{IN}=14V$ ,  $I_{OUT}=0mA$  to  $40mA$ )

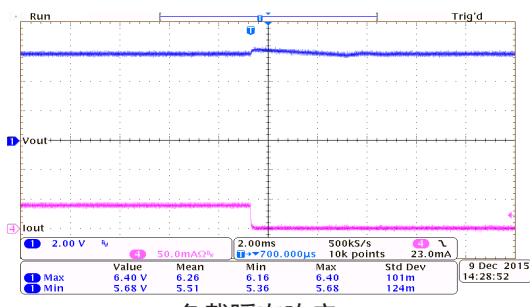

负载瞬态响应：  
HT7560-7 ( $V_{IN}=8.0V$ ,  $I_{OUT}=40mA$  to  $0mA$ )

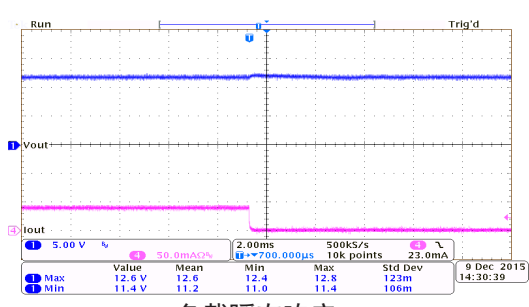

负载瞬态响应：  
HT75C0-7 ( $V_{IN}=14V$ ,  $I_{OUT}=40mA$  to  $0mA$ )



此规格测试条件为： $V_{IN}=V_{OUT}+2V$ ,  $V_{CE}=V_{IN}$ ,  $I_{OUT}=10mA$ ,  $C_{IN}=10\mu F$ ,  $C_{OUT}=10\mu F$ ,  $T_a=25^{\circ}C$ , 除非另有说明。

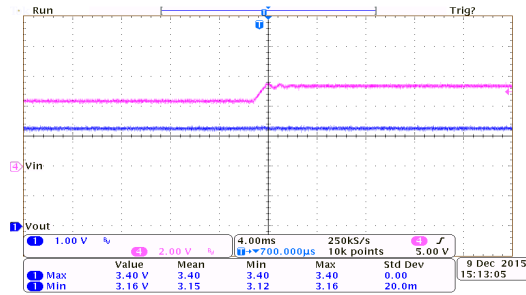

线性瞬态响应: HT7533-7 ( $I_{OUT}=10mA$ )

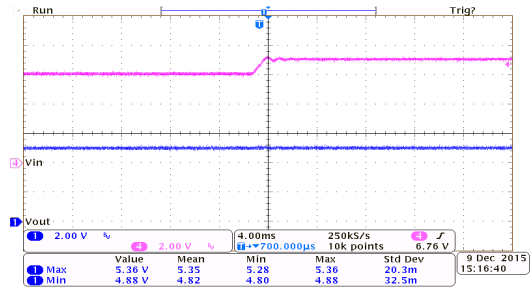

线性瞬态响应: HT7550-7 ( $I_{OUT}=10mA$ )

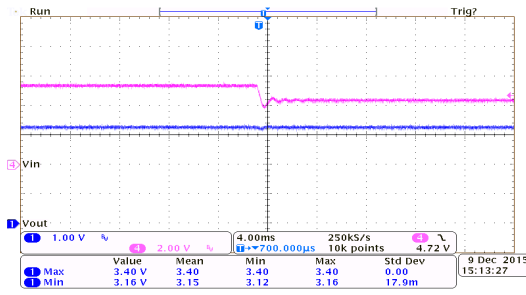

线性瞬态响应: HT7533-7 ( $I_{OUT}=10mA$ )

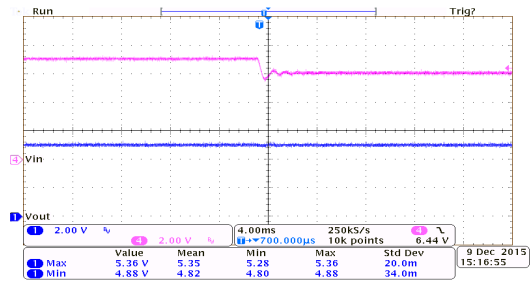

线性瞬态响应: HT7550-7 ( $I_{OUT}=10mA$ )

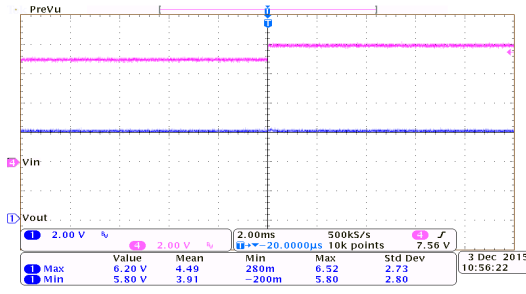

线性瞬态响应: HT7560-7 ( $I_{OUT}=10mA$ )

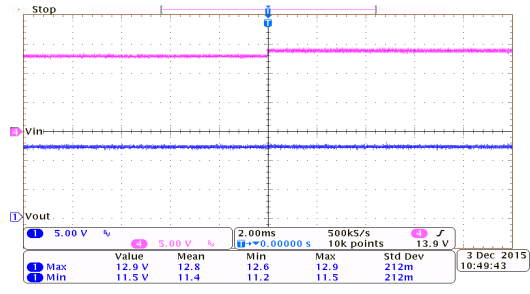

线性瞬态响应: HT75C0-7 ( $I_{OUT}=10mA$ )

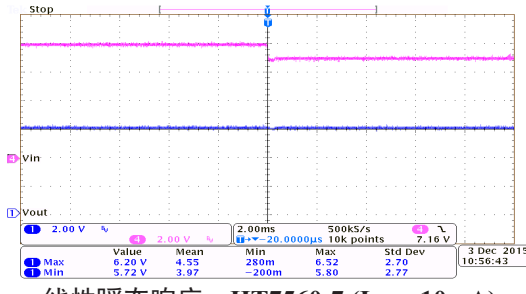

线性瞬态响应: HT7560-7 ( $I_{OUT}=10mA$ )

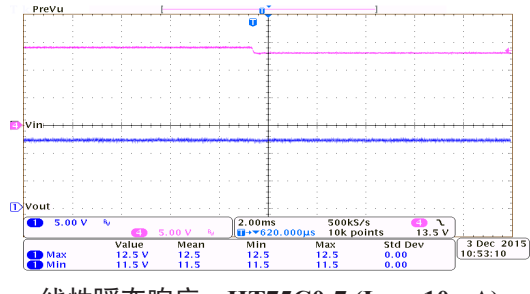

线性瞬态响应: HT75C0-7 ( $I_{OUT}=10mA$ )

此规格测试条件为： $V_{IN}=V_{OUT}+2V$ ,  $V_{CE}=V_{IN}$ ,  $I_{OUT}=10mA$ ,  $C_{IN}=10\mu F$ ,  $C_{OUT}=10\mu F$ ,  $T_a=25^{\circ}C$ , 除非另有说明。

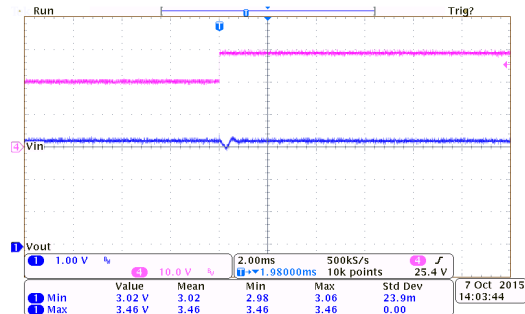

线性瞬态响应: HT7533-7 ( $I_{OUT}=10mA$ )

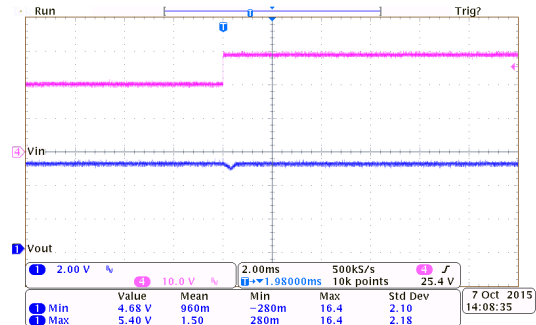

线性瞬态响应: HT7550-7 ( $I_{OUT}=10mA$ )

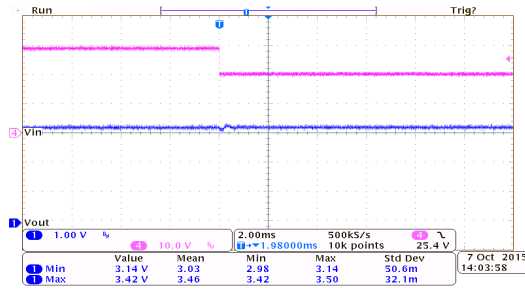

线性瞬态响应: HT7533-7 ( $I_{OUT}=10mA$ )

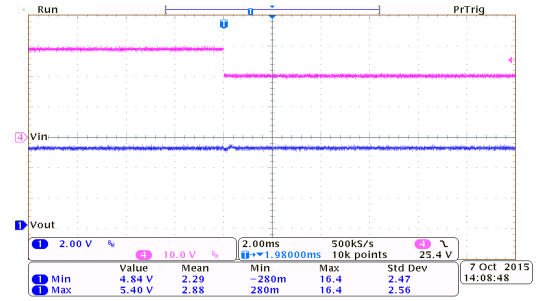

线性瞬态响应: HT7550-7 ( $I_{OUT}=10mA$ )

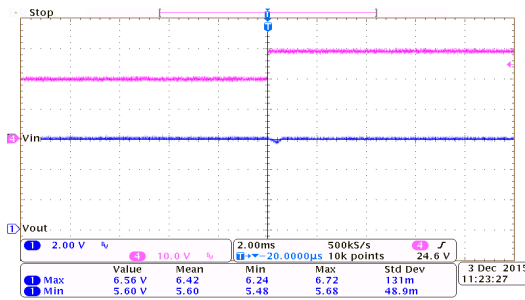

线性瞬态响应: HT7560-7 ( $I_{OUT}=10mA$ )

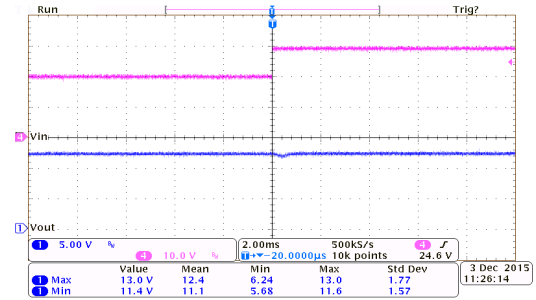

线性瞬态响应: HT75C0-7 ( $I_{OUT}=10mA$ )

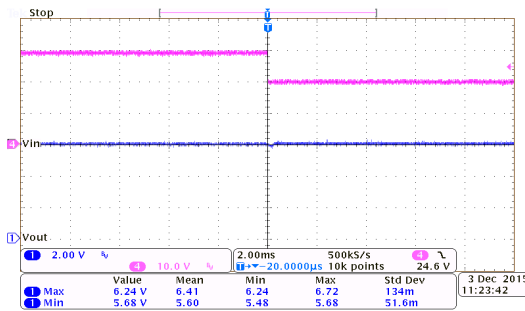

线性瞬态响应: HT7560-7 ( $I_{OUT}=10mA$ )

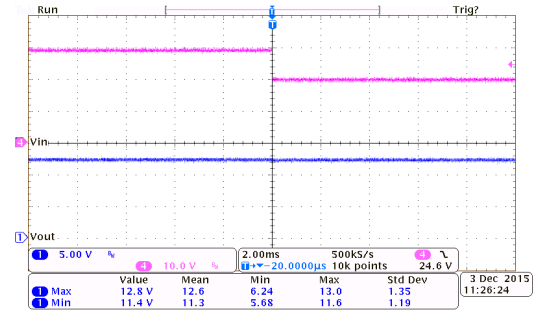

线性瞬态响应: HT75C0-7 ( $I_{OUT}=10mA$ )

此规格测试条件为： $V_{IN}=V_{OUT}+2V$ ,  $V_{CE}=V_{IN}$ ,  $I_{OUT}=10mA$ ,  $C_{IN}=10\mu F$ ,  $C_{OUT}=10\mu F$ ,  $T_a=25^{\circ}C$ , 除非另有说明。

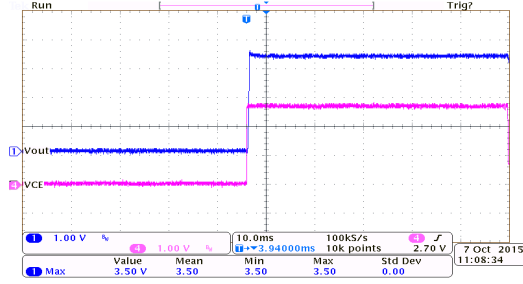

开关响应:  
HT7533-7 ( $I_{OUT}=0mA$ ,  $V_{CE}=0V$  to 2.7V)

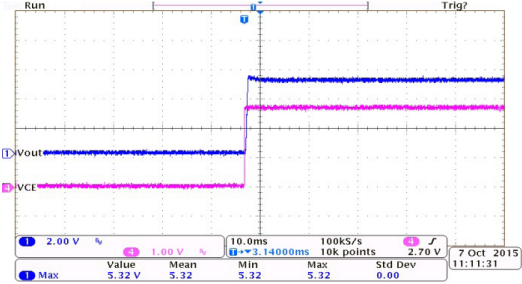

开关响应:  
HT7550-7 ( $I_{OUT}=0mA$ ,  $V_{CE}=0V$  to 2.7V)

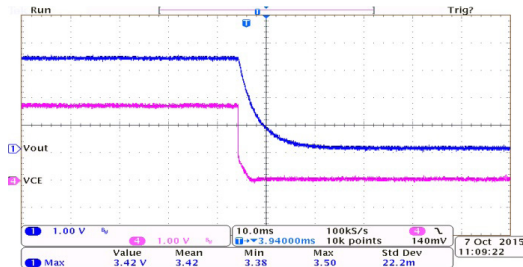

开关响应:  
HT7533-7 ( $I_{OUT}=0mA$ ,  $V_{CE}=2.7V$  to 0V)

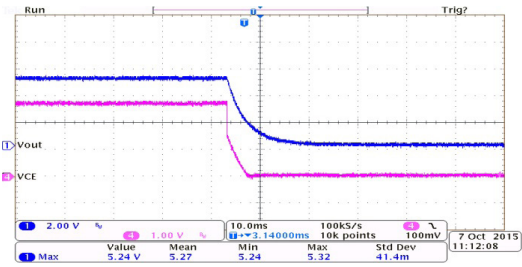

开关响应:  
HT7550-7 ( $I_{OUT}=0mA$ ,  $V_{CE}=2.7V$  to 0V)

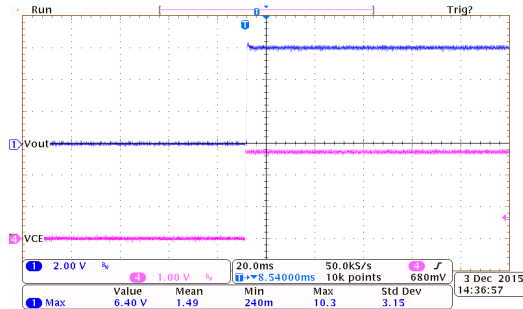

开关响应:  
HT7560-7 ( $I_{OUT}=0mA$ ,  $V_{CE}=0V$  to 2.7V)

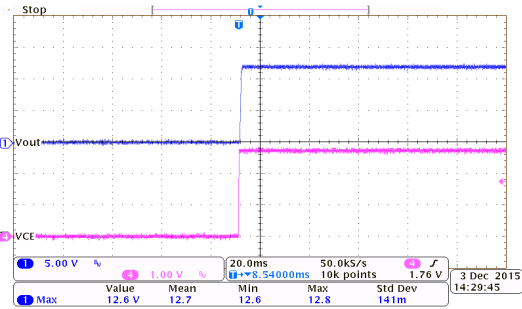

开关响应:  
HT75C0-7 ( $I_{OUT}=0mA$ ,  $V_{CE}=0V$  to 2.7V)

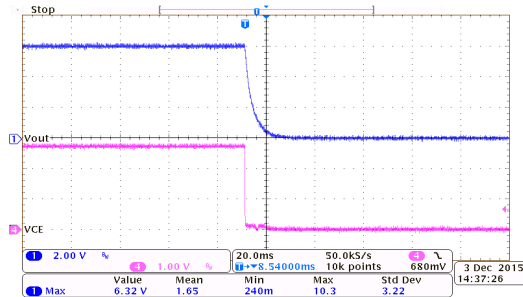

开关响应:  
HT7560-7 ( $I_{OUT}=0mA$ ,  $V_{CE}=2.7V$  to 0V)

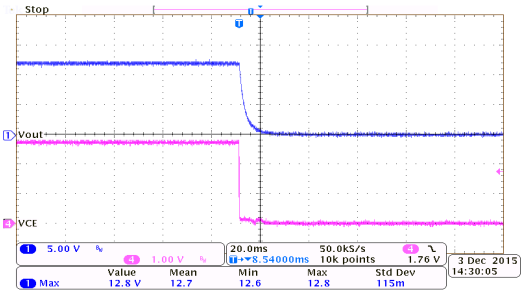

开关响应:  
HT75C0-7 ( $I_{OUT}=0mA$ ,  $V_{CE}=2.7V$  to 0V)

此规格测试条件为： $V_{IN}=V_{OUT}+2V$ ,  $V_{CE}=V_{IN}$ ,  $I_{OUT}=10mA$ ,  $C_{IN}=10\mu F$ ,  $C_{OUT}=10\mu F$ ,  $T_a=25^{\circ}C$ , 除非另有说明。

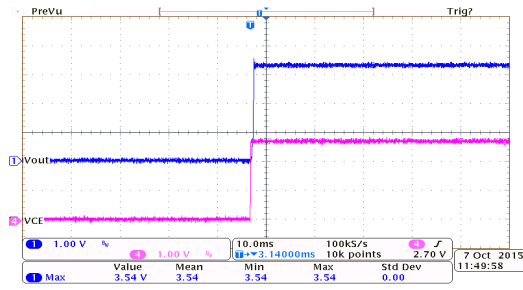

开关响应:  
HT7533-7 ( $I_{OUT}=100mA$ ,  $V_{CE}=0V$  to 2.7V)

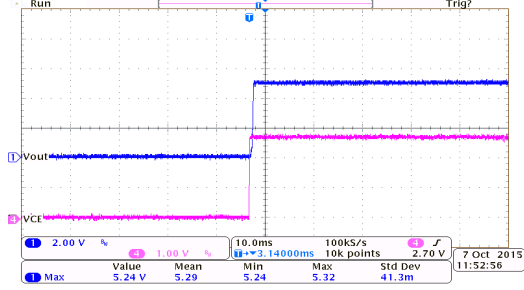

开关响应:  
HT7550-7 ( $I_{OUT}=150mA$ ,  $V_{CE}=0V$  to 2.7V)

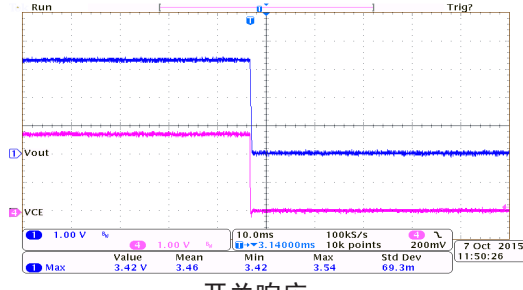

开关响应:  
HT7533-7 ( $I_{OUT}=100mA$ ,  $V_{CE}=2.7V$  to 0V)

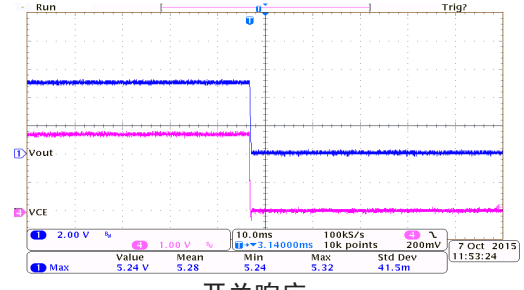

开关响应:  
HT7550-7 ( $I_{OUT}=150mA$ ,  $V_{CE}=2.7V$  to 0V)

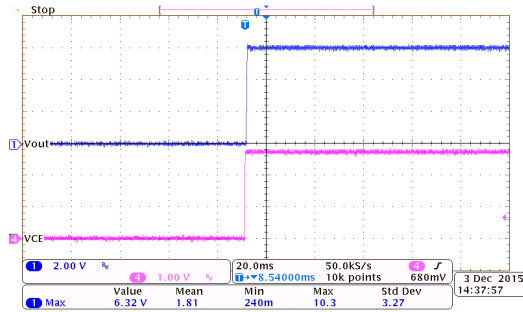

开关响应:  
HT7560-7 ( $I_{OUT}=150mA$ ,  $V_{CE}=0V$  to 2.7V)

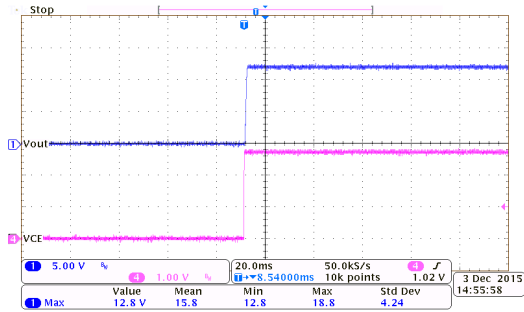

开关响应:  
HT75C0-7 ( $I_{OUT}=150mA$ ,  $V_{CE}=0V$  to 2.7V)

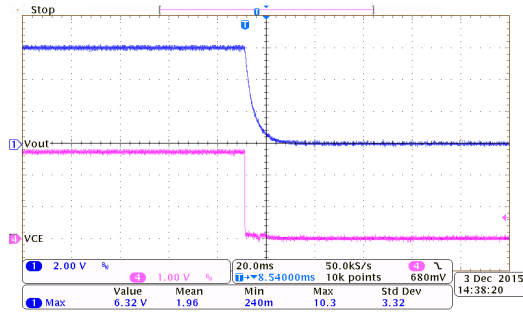

开关响应:  
HT7560-7 ( $I_{OUT}=150mA$ ,  $V_{CE}=2.7V$  to 0V)

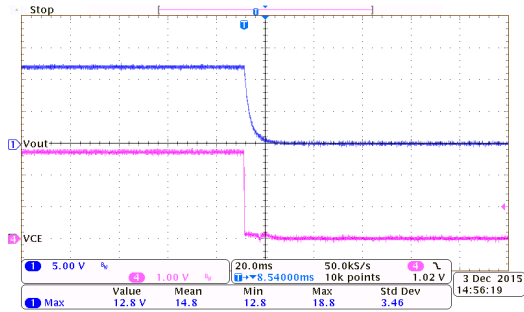

开关响应:  
HT75C0-7 ( $I_{OUT}=150mA$ ,  $V_{CE}=2.7V$  to 0V)

此规格测试条件为： $V_{IN}=V_{OUT}+2V$ ,  $V_{CE}=V_{IN}$ ,  $I_{OUT}=10mA$ ,  $C_{IN}=10\mu F$ ,  $C_{OUT}=10\mu F$ ,  $T_a=25^{\circ}C$ , 除非另有说明。

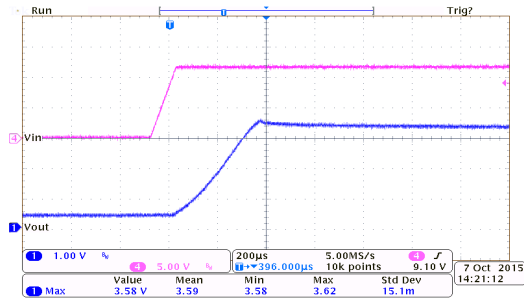

上电响应:  
HT7533-7 ( $I_{OUT}=0mA$ ,  $T_{RISE}=0.1ms$ )

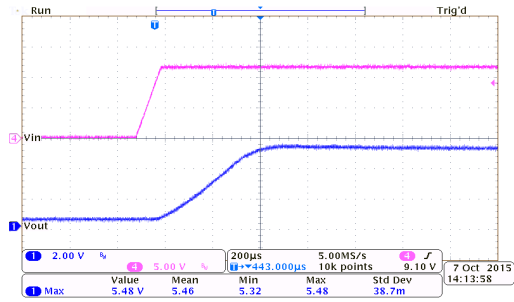

上电响应:  
HT7550-7 ( $I_{OUT}=0mA$ ,  $T_{RISE}=0.1ms$ )

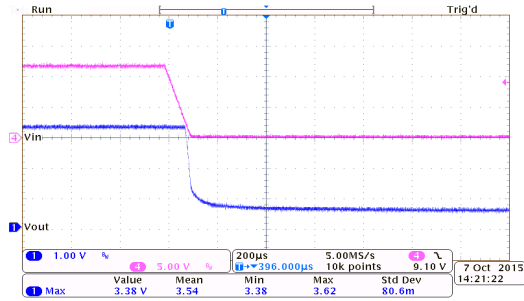

掉电响应:  
HT7533-7 ( $I_{OUT}=0mA$ ,  $T_{FALL}=0.1ms$ )

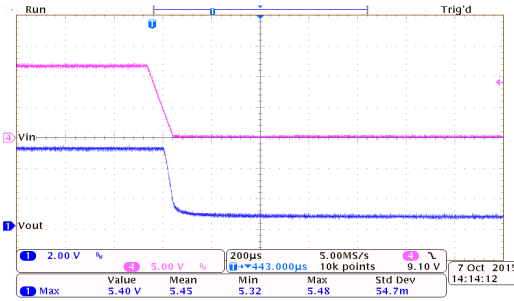

掉电响应:  
HT7550-7 ( $I_{OUT}=0mA$ ,  $T_{FALL}=0.1ms$ )

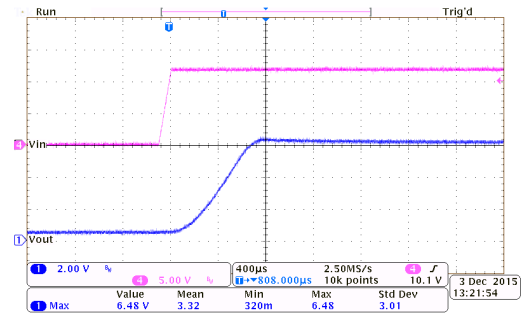

上电响应:  
HT7560-7 ( $I_{OUT}=0mA$ ,  $T_{RISE}=0.1ms$ )

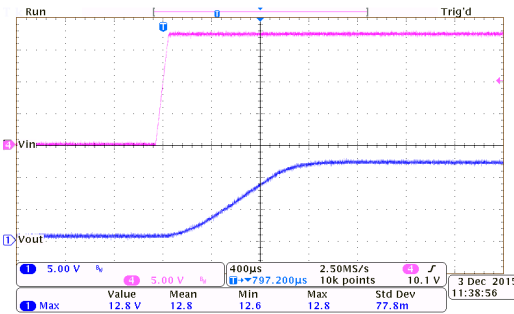

上电响应:  
HT75C0-7 ( $I_{OUT}=0mA$ ,  $T_{RISE}=0.1ms$ )

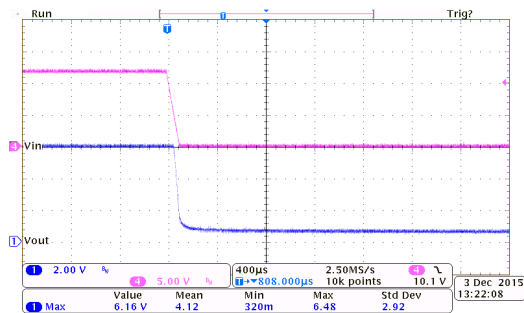

掉电响应:  
HT7560-7 ( $I_{OUT}=0mA$ ,  $T_{FALL}=0.1ms$ )

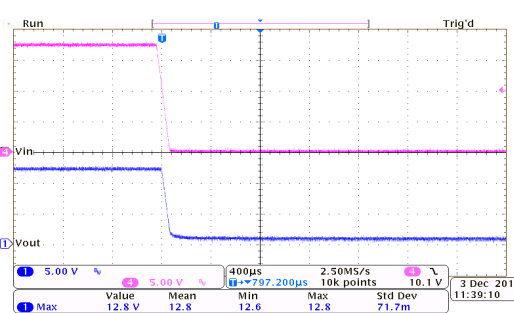

掉电响应:  
HT75C0-7 ( $I_{OUT}=0mA$ ,  $T_{FALL}=0.1ms$ )

此规格测试条件为： $V_{IN}=V_{OUT}+2V$ ,  $V_{CE}=V_{IN}$ ,  $I_{OUT}=10mA$ ,  $C_{IN}=10\mu F$ ,  $C_{OUT}=10\mu F$ ,  $T_a=25^{\circ}C$ , 除非另有说明。

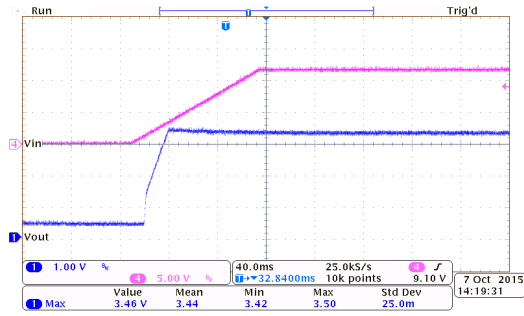

上电响应:  
HT7533-7 ( $I_{OUT}=0mA$ ,  $T_{RISE}=100ms$ )

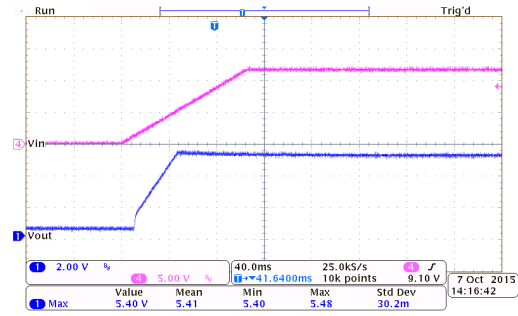

上电响应:  
HT7550-7 ( $I_{OUT}=0mA$ ,  $T_{RISE}=100ms$ )

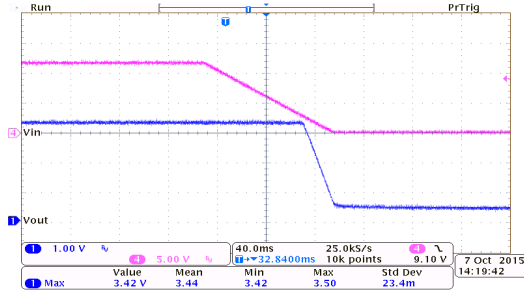

掉电响应:  
HT7533-7 ( $I_{OUT}=0mA$ ,  $T_{FALL}=100ms$ )

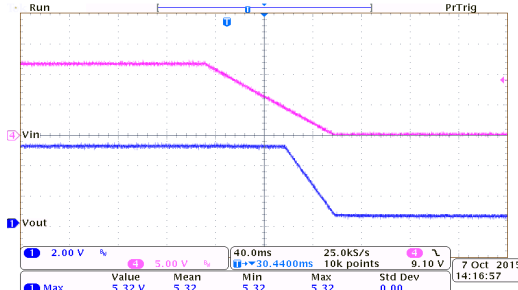

掉电响应:  
HT7550-7 ( $I_{OUT}=0mA$ ,  $T_{FALL}=100ms$ )

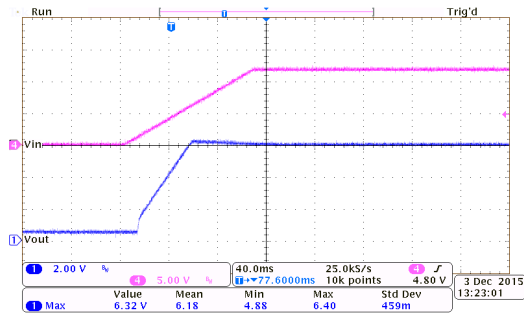

上电响应:  
HT7560-7 ( $I_{OUT}=0mA$ ,  $T_{RISE}=100ms$ )

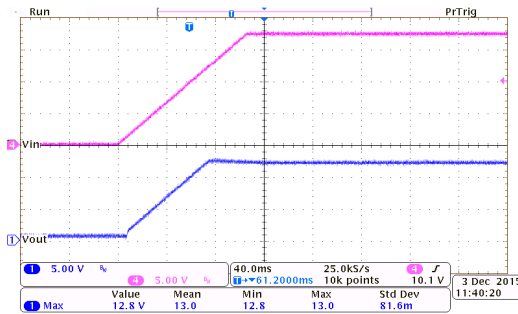

上电响应:  
HT75C0-7 ( $I_{OUT}=0mA$ ,  $T_{RISE}=100ms$ )

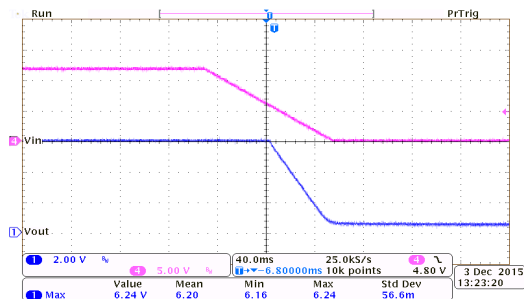

掉电响应:  
HT7560-7 ( $I_{OUT}=0mA$ ,  $T_{FALL}=100ms$ )

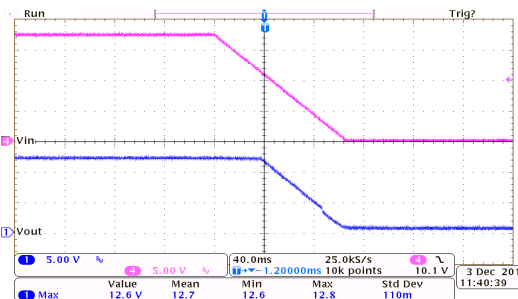

掉电响应:  
HT75C0-7 ( $I_{OUT}=0mA$ ,  $T_{FALL}=100ms$ )

此规格测试条件为： $V_{IN}=V_{OUT}+2V$ ,  $V_{CE}=V_{IN}$ ,  $I_{OUT}=10mA$ ,  $C_{IN}=10\mu F$ ,  $C_{OUT}=10\mu F$ ,  $T_a=25^{\circ}C$ , 除非另有说明。

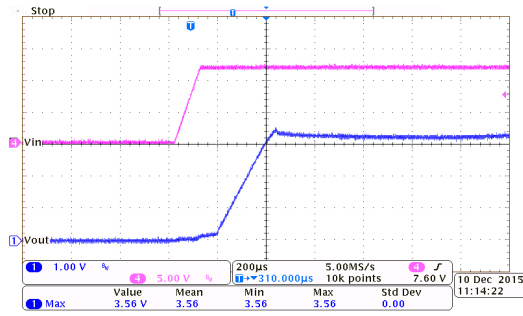

上电响应:  
HT7533-7 ( $I_{OUT}=100mA$ ,  $T_{RISE}=0.1ms$ )

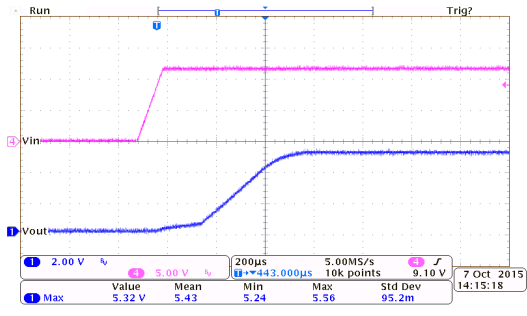

上电响应:  
HT7550-7 ( $I_{OUT}=150mA$ ,  $T_{RISE}=0.1ms$ )

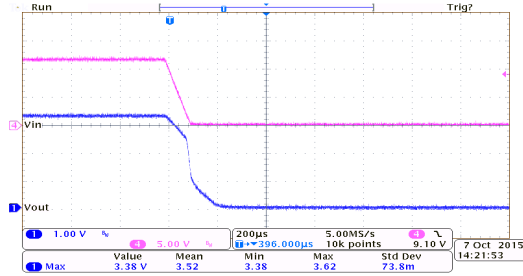

掉电响应:  
HT7533-7 ( $I_{OUT}=100mA$ ,  $T_{FALL}=0.1ms$ )

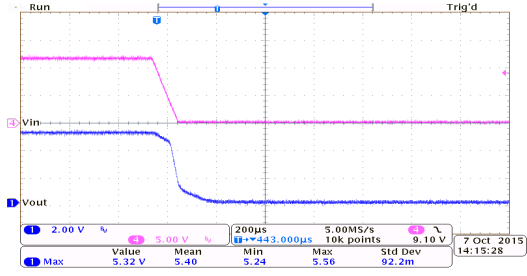

掉电响应:  
HT7550-7 ( $I_{OUT}=150mA$ ,  $T_{FALL}=0.1ms$ )

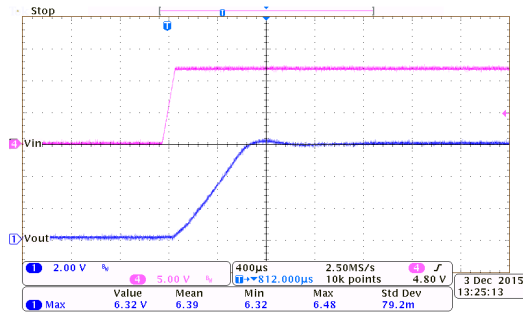

上电响应:  
HT7560-7 ( $I_{OUT}=150mA$ ,  $T_{RISE}=0.1ms$ )

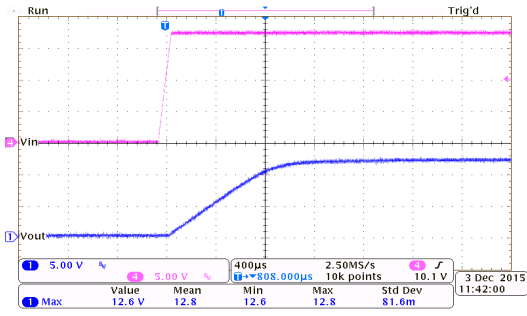

上电响应:  
HT75C0-7 ( $I_{OUT}=150mA$ ,  $T_{RISE}=0.1ms$ )

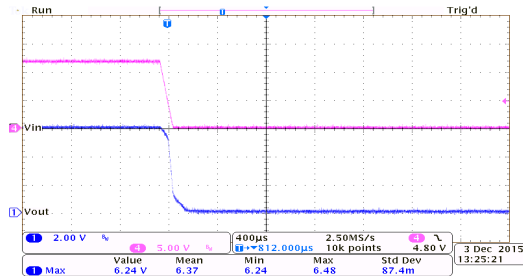

掉电响应:  
HT7560-7 ( $I_{OUT}=150mA$ ,  $T_{FALL}=0.1ms$ )

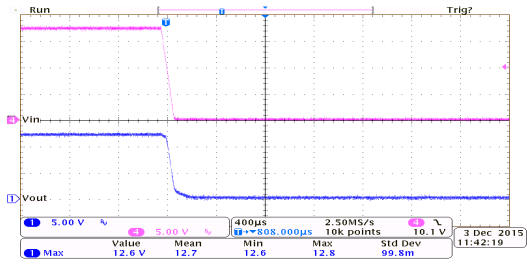

掉电响应:  
HT75C0-7 ( $I_{OUT}=150mA$ ,  $T_{FALL}=0.1ms$ )

此规格测试条件为： $V_{IN}=V_{OUT}+2V$ ,  $V_{CE}=V_{IN}$ ,  $I_{OUT}=10mA$ ,  $C_{IN}=10\mu F$ ,  $C_{OUT}=10\mu F$ ,  $T_a=25^{\circ}C$ , 除非另有说明。

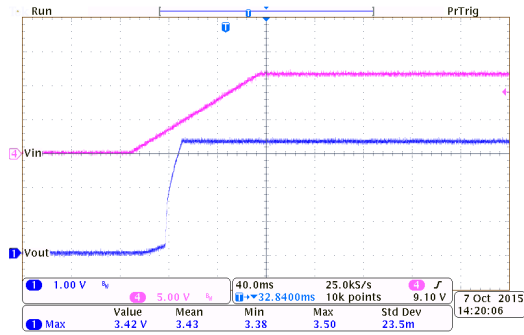

上电响应：  
HT7533-7 ( $I_{OUT}=100mA$ ,  $T_{RISE}=100ms$ )

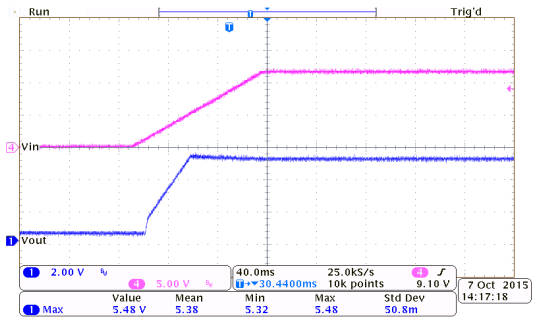

上电响应：  
HT7550-7 ( $I_{OUT}=150mA$ ,  $T_{RISE}=100ms$ )

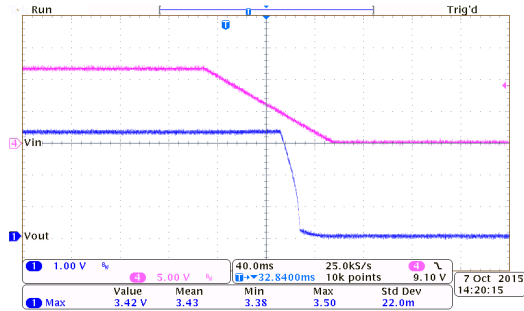

掉电响应：  
HT7533-7 ( $I_{OUT}=100mA$ ,  $T_{FALL}=100ms$ )

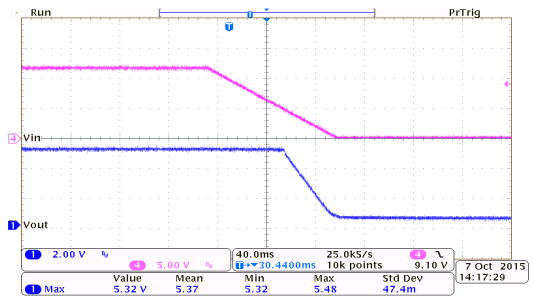

掉电响应：  
HT7550-7 ( $I_{OUT}=150mA$ ,  $T_{FALL}=100ms$ )

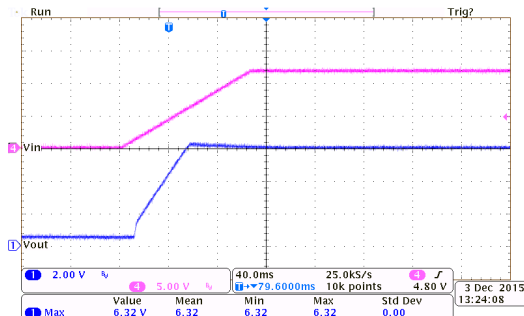

上电响应：  
HT7560-7 ( $I_{OUT}=150mA$ ,  $T_{RISE}=100ms$ )

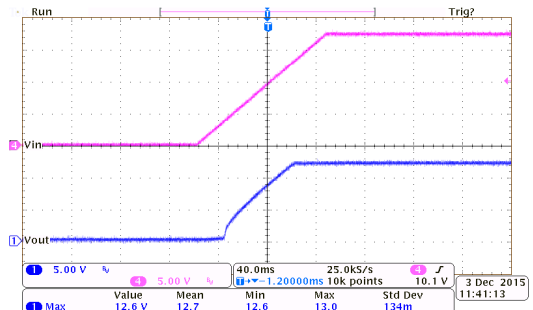

上电响应：  
HT75C0-7 ( $I_{OUT}=150mA$ ,  $T_{RISE}=100ms$ )

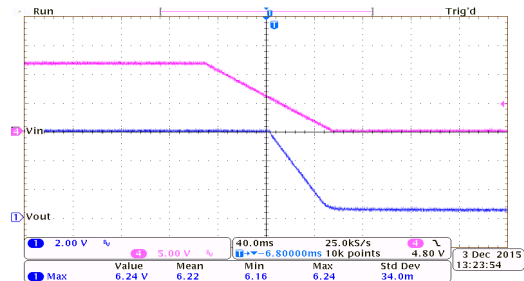

掉电响应：  
HT7560-7 ( $I_{OUT}=150mA$ ,  $T_{FALL}=100ms$ )

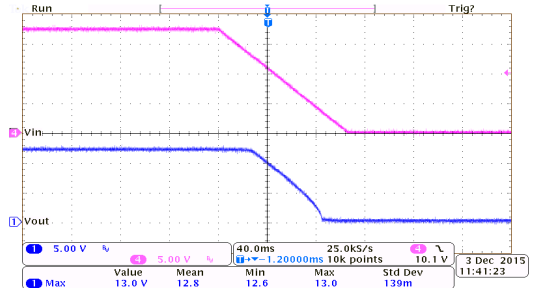

掉电响应：  
HT75C0-7 ( $I_{OUT}=150mA$ ,  $T_{FALL}=100ms$ )



## 应用信息

要使 HT75xx-7 稳压器实现正确的操作，以下应用要点很重要，须特别注意。

### 外部电路

在输入脚和输出脚上连接外部电容是很重要的。输入引脚应该连接合适的旁路电容，如应用电路图所示，尤其是电池电源阻抗较高的情况。输出引脚应连接一个合适的电容，尤其当负载有瞬态特性时，应选择较大电容值来限制可能的瞬态输出电压。

### 热敏考虑

芯片最大功耗取决于芯片封装的热阻、PCB 布局、周围气流速度以及结点与环境温度的温差。最大功耗计算公式：

$$P_{D(MAX)} = (T_{J(MAX)} - T_a) / \theta_{JA}$$

其中， $T_{J(MAX)}$  为最大结温， $T_a$  为环境温度， $\theta_{JA}$  为芯片封装中结至环境的热阻，单位为  $^{\circ}C/W$ 。下列表格将描述不同封装类型的  $\theta_{JA}$  值。

封装	$\theta_{JA}$ 值 $^{\circ}C/W$
SOT89	200 $^{\circ}C/W$
SOT23-5	500 $^{\circ}C/W$

工作极限参数中，最大结温是 150 $^{\circ}C$ 。尽管如此，建议正常工作时最大结温不超过 125 $^{\circ}C$  以确保其可靠性。不同封装的最大功耗降额曲线图如下：

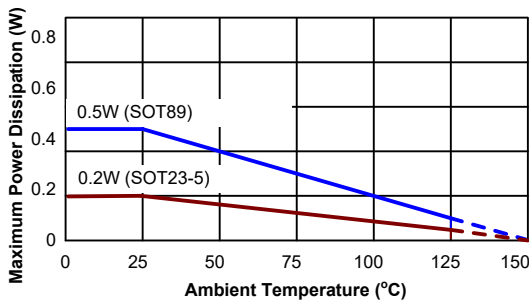

## 功耗计算

为了确保芯片工作在极限参数范围内且能够维持一个稳定的输出电压，芯片的功耗  $P_D$  必须不能超过最大功耗  $P_{D(MAX)}$ 。即  $P_D \leq P_{D(MAX)}$ 。在下图中可以明显看见，功耗几乎产生于传输晶体管，此晶体管等效于一个可变电阻与负载串联，用于确保输出电压恒定。它将以热能的形式产生功耗，必须确保芯片不能超过它的最大结温。

实际应用中，由于负载的瞬态特性，稳压器可能被要求用来提供稳态电流和瞬态电流。即使芯片在极限参数下可以以稳态电流的形式正常运行，仍须注意的是，瞬态负载可能导致电流增加到逼近最大电流值。同样须注意的是，瞬态负载和电流将导致芯片结温上升，但是不允许超过最大结温。芯片发热时，其稳态电流值和瞬态电流值应采用平均值或更准确的均方根值。下图将描述平均电流和瞬态电流的关系。

由于芯片的静态电流非常小，通常可以忽略，因此可以假设输入电流等于输出电流。芯片的功耗  $P_D$  可通过等式： $(V_{IN} - V_{OUT}) \times I_{IN}$  计算得出，即输入和输出的电压降与电流相乘。输入电流也等于负载电流，所以功耗  $P_D = (V_{IN} - V_{OUT}) \times I_{LOAD}$ 。由于瞬态负载电流的存在， $P_D = (V_{IN} - V_{OUT}) \times I_{LOAD(AVG)}$ ，如图中所示。

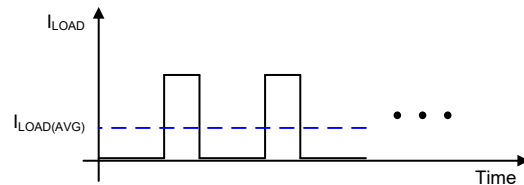

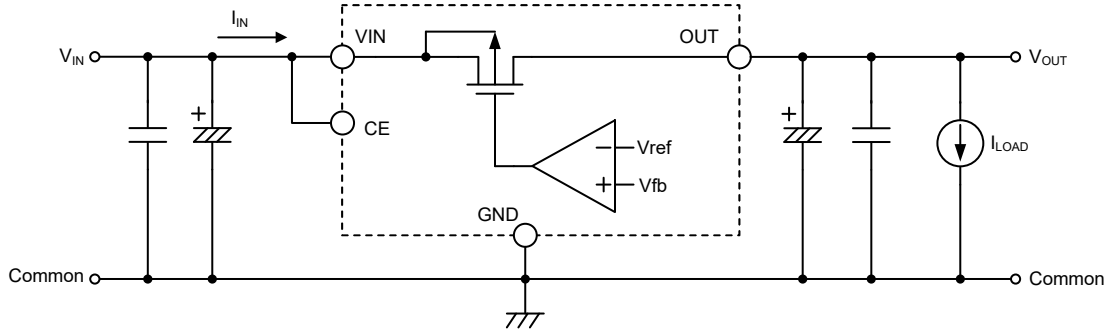

## 应用电路

### 基本电路

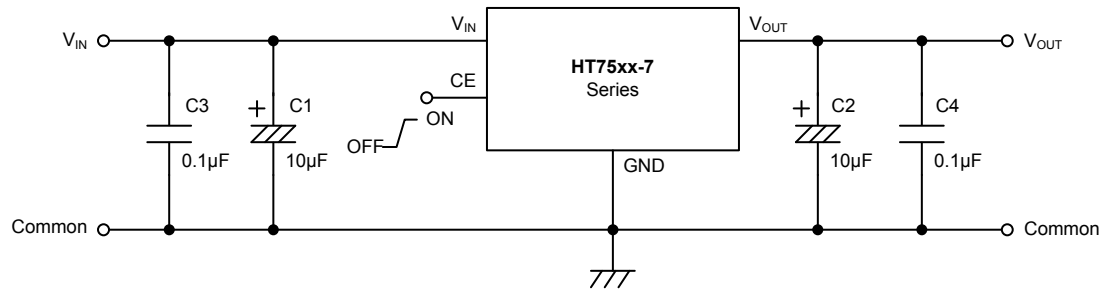

### 大电流输出正电压稳压器

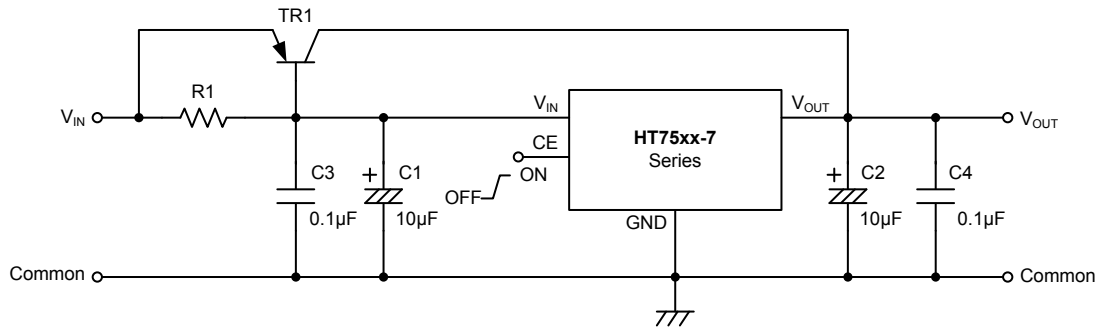

用于增加输出电压的电路

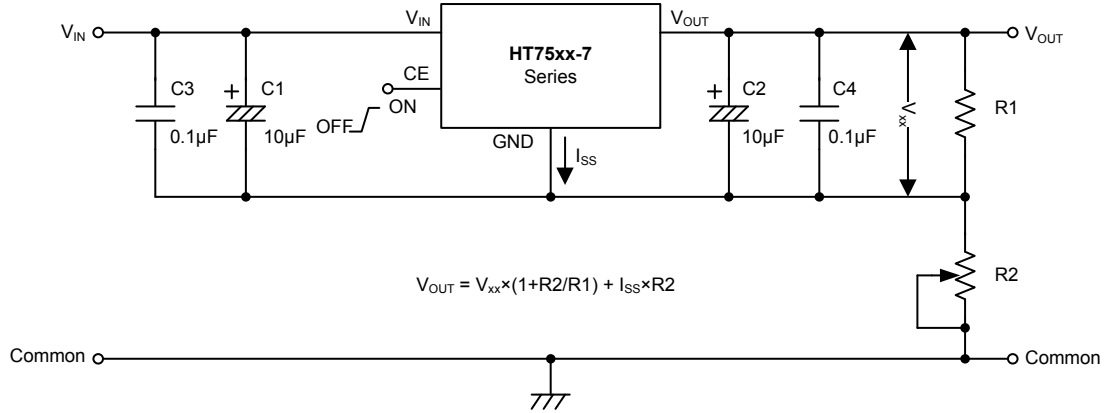

用于增加输出电压的电路

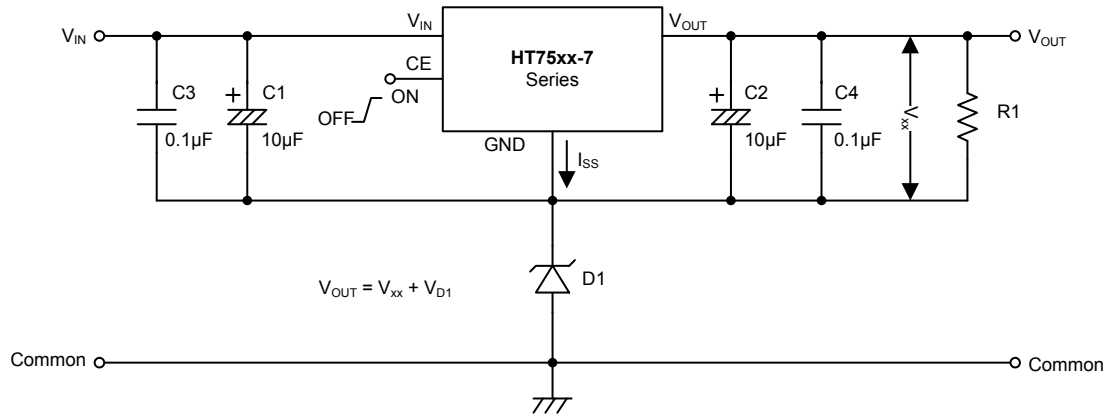

恒流稳压器

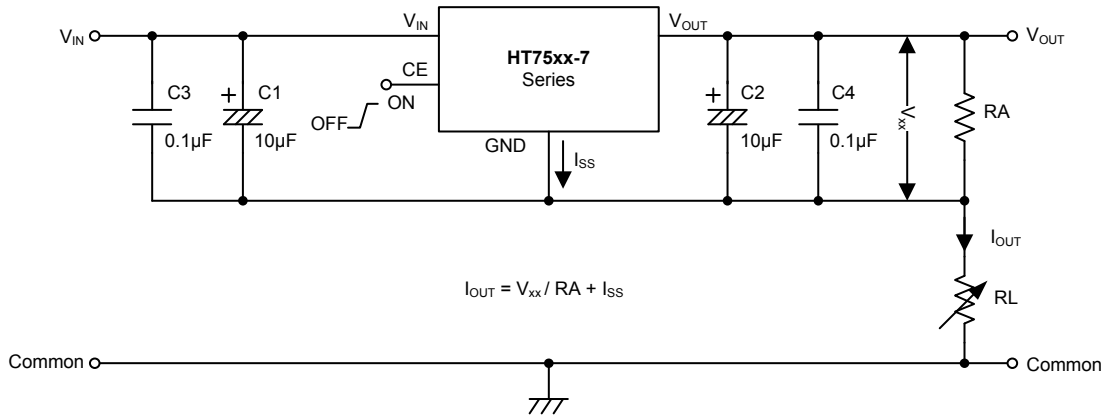

双电源电路

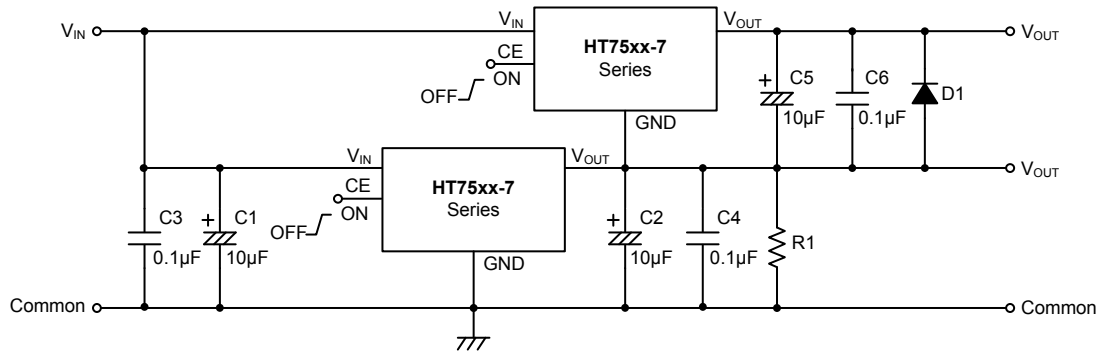

## 封装信息

请注意，这里提供的封装信息仅作为参考。由于这个信息经常更新，提醒用户咨询 [Holtek 网站](#) 以获取最新版本的 [封装信息](#)。

封装信息的相关内容如下所示，点击可链接至 Holtek 网站相关信息页面。

- 封装信息（包括外形尺寸、包装带和卷轴规格）
- 封装材料信息
- 纸箱信息

3-pin SOT89 外形尺寸

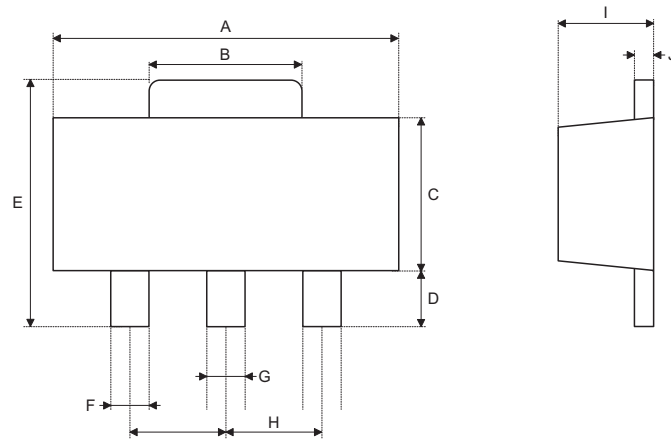

符号	尺寸 (单位: inch)		
	最小值	正常值	最大值
A	0.173	—	0.185
B	0.053	—	0.072
C	0.090	—	0.106
D	0.031	—	0.047
E	0.155	—	0.173
F	0.014	—	0.019
G	0.017	—	0.022
H	—	0.059 BSC	—
I	0.055	—	0.063
J	0.014	—	0.017

符号	尺寸 (单位: mm)		
	最小值	正常值	最大值
A	4.40	—	4.70
B	1.35	—	1.83
C	2.29	—	2.70
D	0.80	—	1.20
E	3.94	—	4.40
F	0.36	—	0.48
G	0.44	—	0.56
H	—	1.50 BSC	—
I	1.40	—	1.60
J	0.35	—	0.44

## 5-pin SOT23 外形尺寸

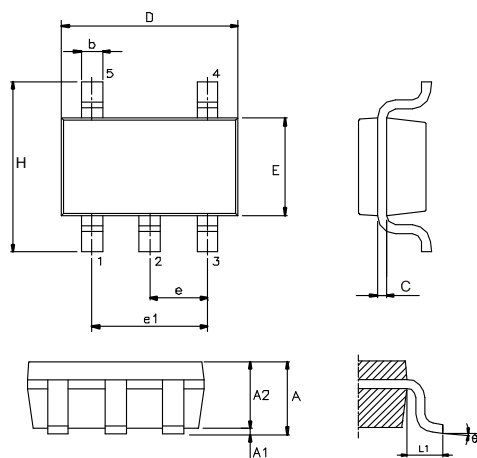

符号	尺寸 (单位: inch)		
	最小值	正常值	最大值
A	—	—	0.057
A1	—	—	0.006
A2	0.035	0.045	0.051
b	0.012	—	0.020
C	0.003	—	0.009
D	—	0.114 BSC	—
E	—	0.063 BSC	—
e	—	0.037 BSC	—
e1	—	0.075 BSC	—
H	—	0.110 BSC	—
L1	—	0.024 BSC	—
θ	0°	—	8°

符号	尺寸 (单位: mm)		
	最小值	正常值	最大值
A	—	—	1.45
A1	—	—	0.15
A2	0.90	1.15	1.30
b	0.30	—	0.50
C	0.08	—	0.22
D	—	2.90 BSC	—
E	—	1.60 BSC	—
e	—	0.95 BSC	—
e1	—	1.90 BSC	—
H	—	2.80 BSC	—
L1	—	0.60 BSC	—
θ	0°	—	8°

Copyright© 2020 by HOLTEK SEMICONDUCTOR INC.

使用指南中所出现的信息在出版当时相信是正确的，然而 **Holtek** 对于说明书的使用不负任何责任。文中提到的应用目的仅仅是用来做说明，**Holtek** 不保证或表示这些没有进一步修改的应用将是适当的，也不推荐它的产品使用在会由于故障或其它原因可能会对人身造成危害的地方。**Holtek** 产品不授权使用于救生、维生从机或系统中做为关键从机。**Holtek** 拥有不事先通知而修改产品的权利，对于最新的信息，请参考我们的网址 <http://www.holtek.com/zh/>.