

High SPL Differential Bottom Port SiSonic™ Microphone

The SPA1687LR5H-1 is a miniature, high-performance, low power, bottom port silicon differential microphone. Using Knowles' proven high performance SiSonic™ MEMS technology, the SPA1687LR5H-1 consists of an acoustic sensor, a low noise input buffer, and a differential output amplifier. These devices are suitable for applications such as cellphones, smart phones, laptop computers, sensors, digital still cameras, portable music recorders, and other portable electronic devices where excellent wideband audio performance and RF immunity are required.

Product Features

- High SPL
- Low Noise
- Flat Frequency Response
- Differential Output
- Small Package
- Low Current
- MaxRF Protection
- Bottom Port
- Ultra-Stable Performance
- Standard SMD Reflow
- Omnidirectional

Typical Applications

- Portable electronics
- Cellphones
- Laptop Computers
- Tablets
- Digital Still Cameras
- Portable Music Recorders

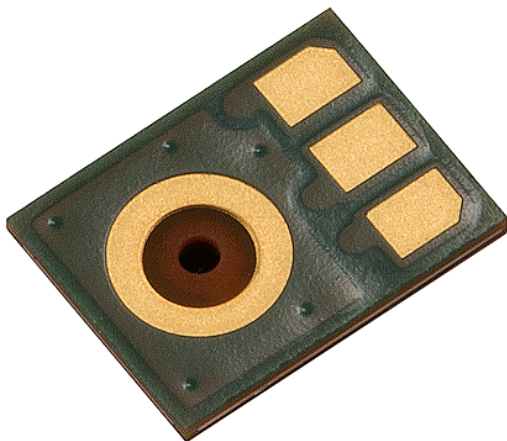

Absolute Maximum Ratings

Table 1: Absolute Maximum Ratings

Parameter	Absolute Maximum Rating	Units
Vdd to Ground	-0.5, +5.0	V
Out-, Out+ to Ground	-0.3, Vdd+0.3	V
Input Current to any pin	±5	mA
Storage Temperature	-40 to +100	°C
Operating Temperature	-30 to +100	°C

Stresses exceeding these “Absolute Maximum Ratings” may cause permanent damage to the device. These are stress ratings only. Functional operation at these or any other conditions beyond those indicated under “Acoustic & Electrical Specifications” is not implied. Exposure beyond those indicated under “Acoustic & Electrical Specifications” for extended periods may affect device reliability.

Acoustic & Electrical Specifications¹

Table 2: General Microphone Specifications

Test Conditions: 23 ±2°C, 55±20% R.H., V_{DD}=2.7V, no load, unless otherwise indicate

Parameter	Symbol	Conditions	Min	Typ	Max	Units
Directivity			Omnidirectional			
Polarity		Increasing sound pressure	Increasing Output Voltage			
Startup Time ²		S within 0.5dB on final value	-	-	30	ms
Mode Switch Time		94 dB SPL @ 1 kHz, A-weighted	-	-	30	ms

Table 3: Microphone Specifications

Test Conditions: 23 ±2°C, 55±20% R.H., V_{DD}=2.7V, no load, unless otherwise indicate

Parameter	Symbol	Conditions	Min	Typ	Max	Units
Supply Voltage	Vdd		2.3	2.7	3.6	V
Supply Current	Idd		-	300	325	µA
Sensitivity	S	94 dB SPL @ 1 kHz	-39	-38	-37	dBV/Pa
Signal to Noise Ratio	SNR	94 dB SPL @ 1 kHz, A-weighted	64	65	-	dB(A)
Total Harmonic Distortion	THD	94 dB SPL @ 1 kHz, S = Typ, Rload > 10kΩ	-	0.1	0.5	%
Acoustic Overload Point	AOP	10% THD @ 1 kHz, S = Typ, Rload > 10kΩ	132	-	-	dB SPL
Power Supply Rejection Ratio	PSRR	100 mVpp, sinewave @ 1K Hz	80	85	-	dB
Power Supply Rejection	PSR	100mVpp 7/8 duty cycle rectangular wave @217Hz, A-weight, 20K Hz BW	-	-101	-100	dBV(A)
DC Output			0.59	0.69	0.78	V
Output Impedance	Zout	@ 1 kHz	-	-	600	Ω
Output Load	Cload		-	-	210	pF
	Rload	AC-coupled	7	-	-	kΩ
DC offset		OUT+ to OUT-	-	±5	±50	mV

¹ Sensitivity and Supply Current are 100% tested.

² OUT+ and OUT- must be AC coupled

Application Notes

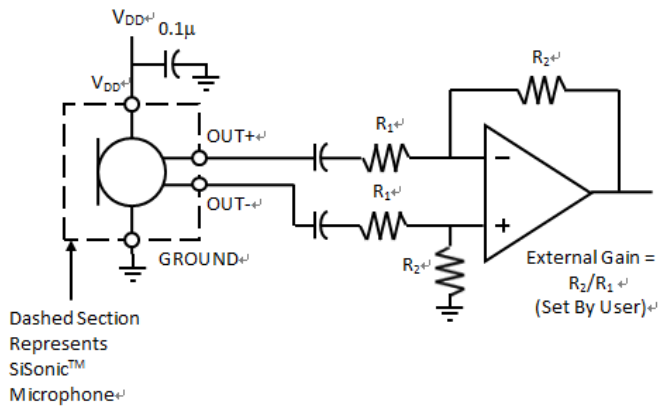

Figure 1: Typical Application Circuit

Notes: Capacitors near the microphone should not contain Class 2 dielectrics due to their piezoelectric effects.

When OUT- is grounded, it is not driven after a subsequent power-up

OUT+ and OUT- must use an AC coupled capacitor

Detailed information on acoustic, mechanical, and system integration can be found in the latest *SiSonic™ Design Guide* application note.

Performance Curves

Test Conditions: 23 ±2°C, 55±20% R.H. V_{DD} =2.7, no load, unless otherwise

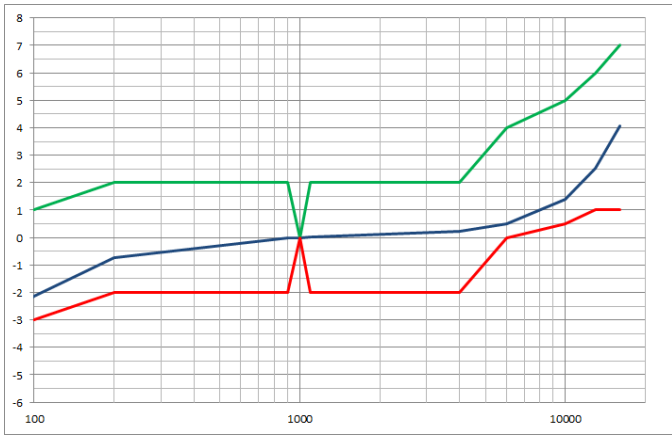

Figure 2: Typical Free Field Response Normalized to 1 kHz

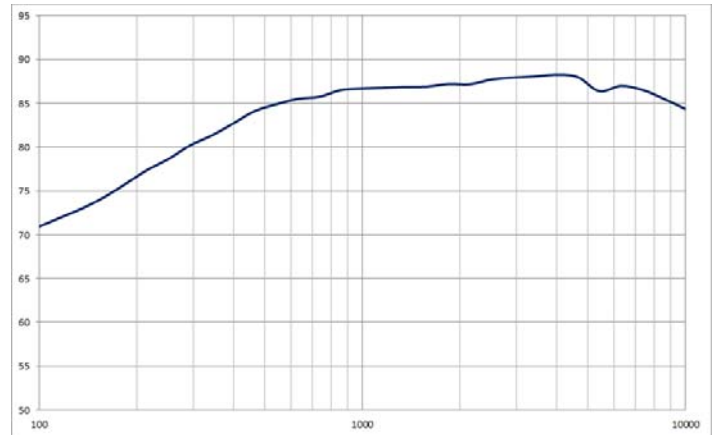

Figure 5: Typical PSRR

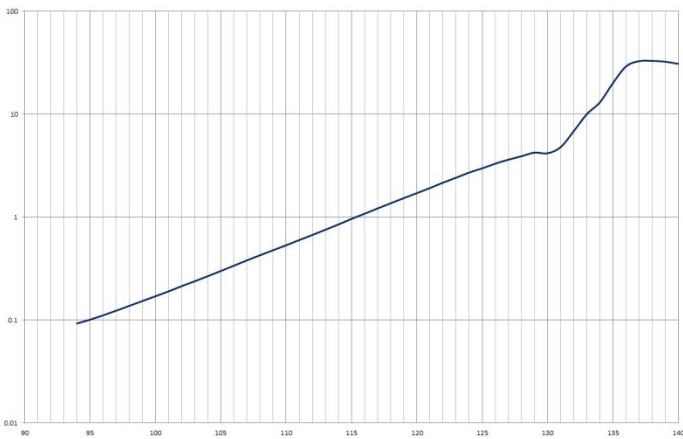

Figure 3: Typical THD vs SPL

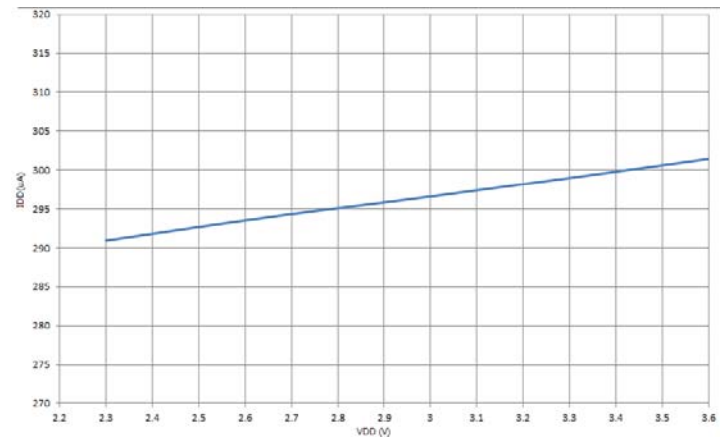

Figure 6: Typical I_{dd} vs V_{dd}

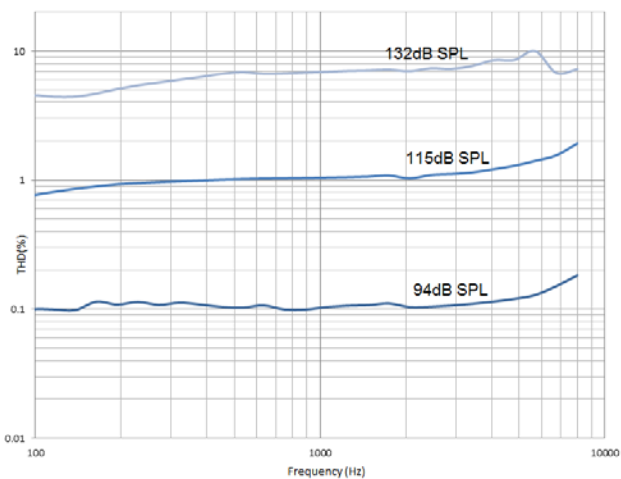

Figure 4: THD vs Frequency Response

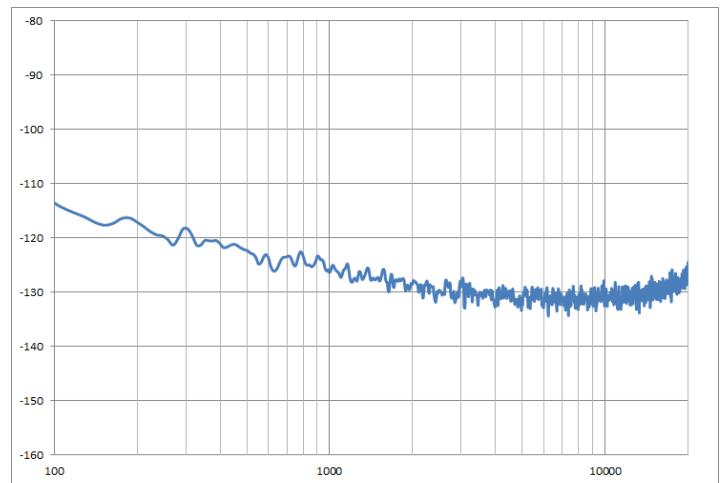
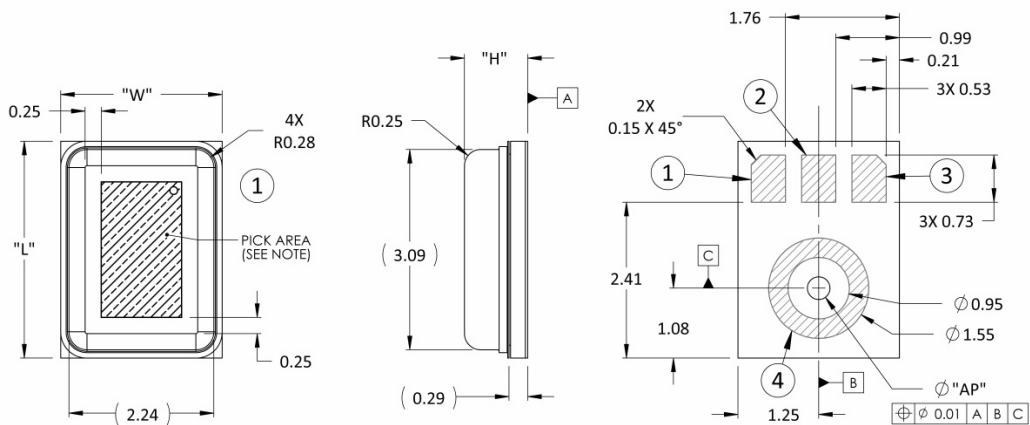

Figure 6: Noise Level

Mechanical Specifications



tem	Dimension	Tolerance
Length (L)	3.35	±0.08
Width (W)	2.50	±0.08
Height (H)	0.98	±0.10
Acoustic Port (AP)	Ø0.25	±0.05

Pin #	Pin Name	Type	Description
1	Vdd	Power	Power Supply
2	OUT-	Signal	Inverted Output Signal
3	OUT+	Signal	Non-Inverted Output Signal
4	GROUND	Power	Ground

Example Land Pattern

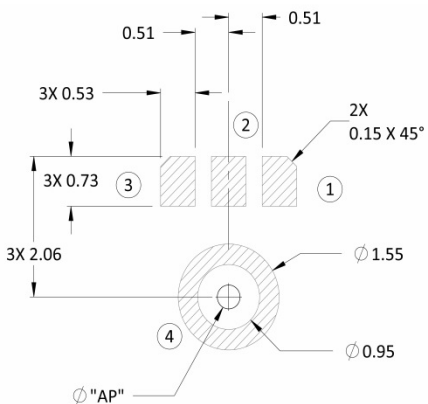

Example Solder Stencil Pattern

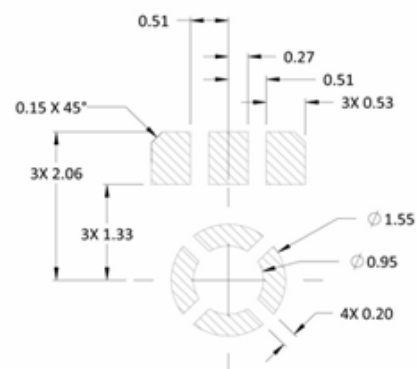

Notes: Pick Area only extends to 0.25 mm of any edge or hole unless otherwise specified.
 Dimensions are in millimeters unless otherwise specified.
 Tolerance is ±0.15mm unless otherwise specified
 Detailed information on AP size considerations can be found in the latest *SiSonic™ Design Guide* application note.
 Further optimizations based on application should be performed.

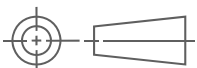

Packaging & Marking Detail

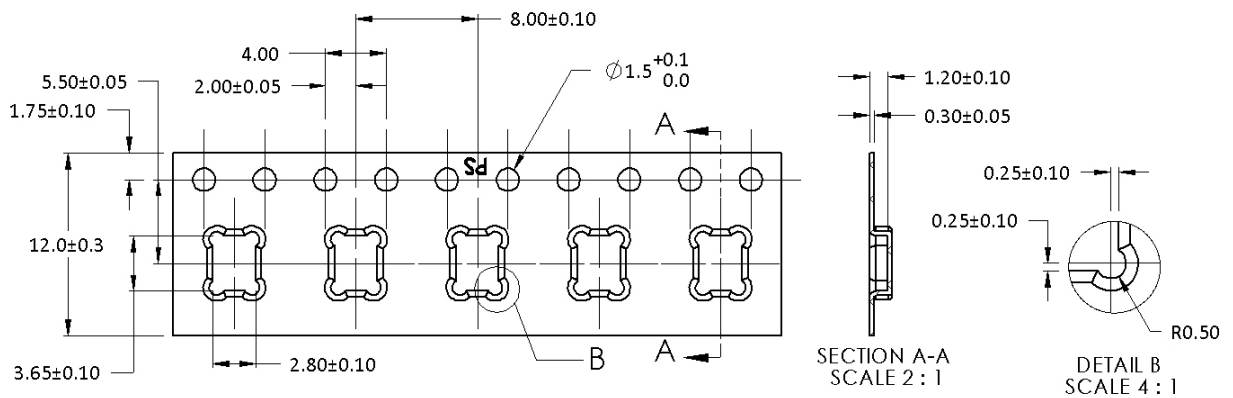

Model Number	Suffix	Reel Diameter	Quantity Per Reel
SPA1687LR5H-1	-8	13"	5,900
SPA1687LR5H-1	-T	13"	300

Alpha Character A:

- "S" Knowles Sisonic Production
- "E" Knowles Engineering Samples
- "P" Knowles Prototype samples

"12345678":

Unique Job Identification Number for Product traceability

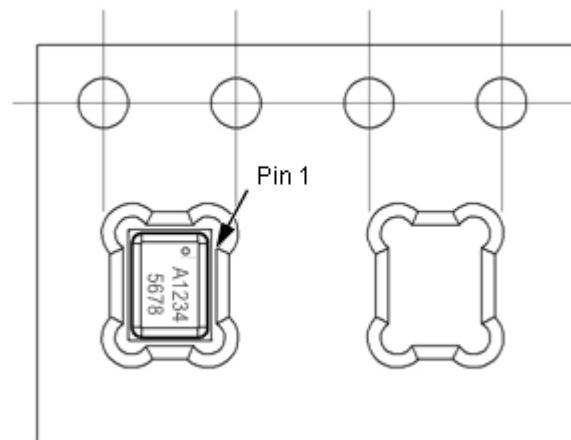

- Notes:
- Dimensions are in millimeters unless otherwise specified.
 - Vacuum pickup only in the pick area indicated in Mechanical Specifications.
 - Tape & reel per EIA-481.
 - Labels applied directly to reel and external package.
 - Shelf life: Twelve (12) months when devices are to be stored in factory supplied, unopened ESD moisture sensitive bag under maximum environmental conditions of 30°C, 70% R.H.

Recommended Reflow Profile

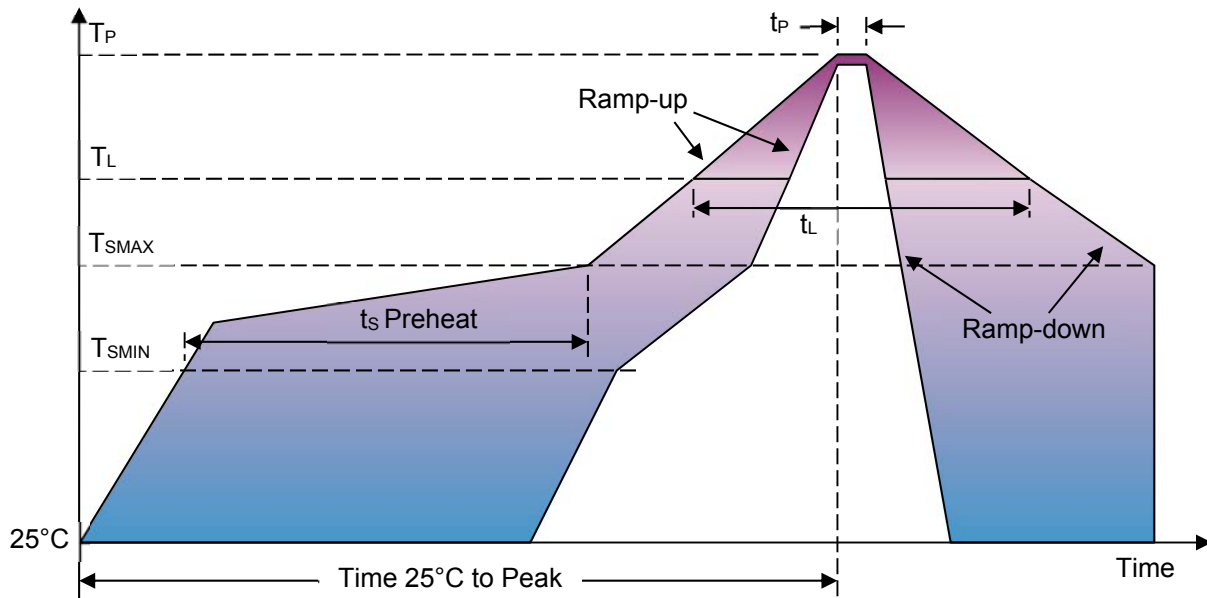

Profile Feature	Pb-Free
Average Ramp-up rate (T_{SMAX} to T_P)	3°C/second max.
Preheat <ul style="list-style-type: none"> Temperature Min (T_{SMIN}) Temperature Max (T_{SMAX}) Time (T_{SMIN} to T_{SMAX}) (t_s) 	150°C 200°C 60-180 seconds
Time maintained above: <ul style="list-style-type: none"> Temperature (T_L) Time (t_L) 	217°C 60-150 seconds
Peak Temperature (T_P)	260°C
Time within 5°C of actual Peak Temperature (t_P)	20-40 seconds
Ramp-down rate (T_P to T_{SMAX})	6°C/second max
Time 25°C to Peak Temperature	8 minutes max

Notes: Based on IPC/JDEC J-STD-020 Revision C.
All temperatures refer to topside of the package, measured on the package body surface

Additional Notes

- MSL (moisture sensitivity level) Class 1.
- Maximum of 3 reflow cycles is recommended.
- In order to minimize device damage:
 - Do not board wash or clean after the reflow process.
 - Do not brush board with or without solvents after the reflow process.
 - Do not directly expose to ultrasonic processing, welding, or cleaning.
 - Do not insert any object in port hole of device at any time.
 - Do not apply over 30 psi of air pressure into the port hole.
 - Do not pull a vacuum over port hole of the microphone.
 - Do not apply a vacuum when repacking into sealed bags at a rate faster than 0.5 atm/sec.
 - Do not directly expose to vapor phase soldering.

Materials Statement

Meets the requirements of the European RoHS directive 2011/65/EC as amended.

Meets the requirements of the industry standard IEC 61249-2-21:2003 for halogenated substances and Knowles Green Materials Standards Policy section on Halogen-Free.

Ozone depleting substances are not used in the product or the processes used to make the product, including compounds listed in Annex A, B, and C of the "Montreal Protocol on Substances That Deplete the Ozone Layer."

Reliability Specifications

Test	Description
Thermal Shock	100 cycles of air-air thermal shock from -40°C to +125°C with 15 minute soaks (IEC 68-2-4)
High Temperature Storage	+105°C environment for 1,000 hours (IEC 68-2-2 Test Ba)
Low Temperature Storage	-40°C environment for 1,000 hours (IEC 68-2-2 Test Aa)
High Temperature Bias	+105°C environment while under bias for 1,000 hours (IEC 68-2-2 Test Ba)
Low Temperature Bias	-40°C environment while under bias for 1,000 hours (IEC 68-2-2 Test Aa)
Temperature/Humidity Bias	+85°C/85% R.H. environment while under bias for 1,000 hours (JESD22-A101A-B)
Vibration	12 minutes in each axis from 20 to 2,000 Hz in X,Y, and Z directions with peak acceleration of 20g (MIL 883E, Method 2007.2,A)
ESD-HBM	3 discharges of ±2 kV direct contact to I/O pins. (ESD STM5.2)
ESD-LID/GND	3 discharges of ±8 kV direct contact to lid while unit is grounded. (IEC 61000-4-2)
ESD-MM	3 discharges of ±200V direct contact to I/O pins. (MIL 883E, Method 3015.7)
Reflow	5 reflow cycles with peak temperature of +260°C
Tumble test	200 tumbles in 100g block from a height of 1m onto a steel base
Mechanical Shock	3 pulses of 10,000g in each of the ±X, ±Y, ±Z directions while under bias (IEC 68-2-27 Test Ea)

Notes: After reliability tests are performed, the sensitivity of the microphones shall not deviate more than 3dB from their initial value.
After 3 reflow cycles, the sensitivity of the microphones shall not deviate more than 1 dB from its initial value.

Specification Revisions

Revision	Specification Changes	Date
A	SPA1687LR5H-1 Rev A (ECR 16-956)	8/18/2016
B	Updated Rmin (AC-coupled) value and operating temperature (ECR 19-3046)	4/25/2019
C	Added max Cload value, PSR units, and comment on vapor phase soldering (ECR 19-3150)	6/18/2019

Information contained herein is subject to change without notice. It may be used by a party at their own discretion and risk. We do not guarantee any results or assume any liability in connection with its use. This publication is not to be taken as a license to operate under any existing patents.