

Data sheet | Item number: 2604-3108

PCB terminal block; lever; 4 mm<sup>2</sup>; Pin spacing 5 mm; 8-pole; Push-in CAGE CLAMP®; 4,00 mm<sup>2</sup>; gray

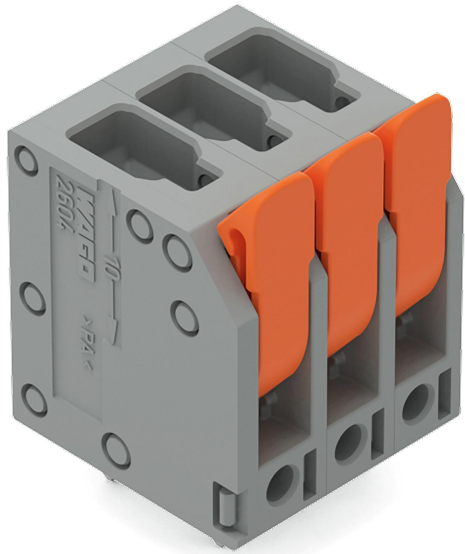

[www.wago.com/2604-3108](http://www.wago.com/2604-3108)



 Picture differs from the item.

Color: 

**Current-Carrying Capacity Curve**  
Pin spacing: 5 mm / Conductor cross-section: 4 mm<sup>2</sup> "f-st"  
Based on: EN 60512-5-2 / Reduction factor: 1

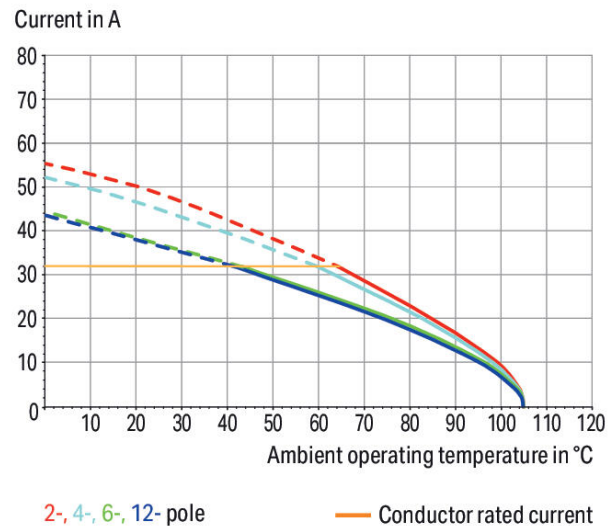

Subject to changes. Please also observe the further product documentation!

WAGO GmbH & Co. KG  
Hansastr. 27  
32423 Minden  
Phone: +49571 887-0 | Fax: +49571 887-169  
Email: [info.de@wago.com](mailto:info.de@wago.com) | Web: [www.wago.com](http://www.wago.com)

Do you have any questions about our products?  
We are always happy to take your call at +49 (571) 887-44222.

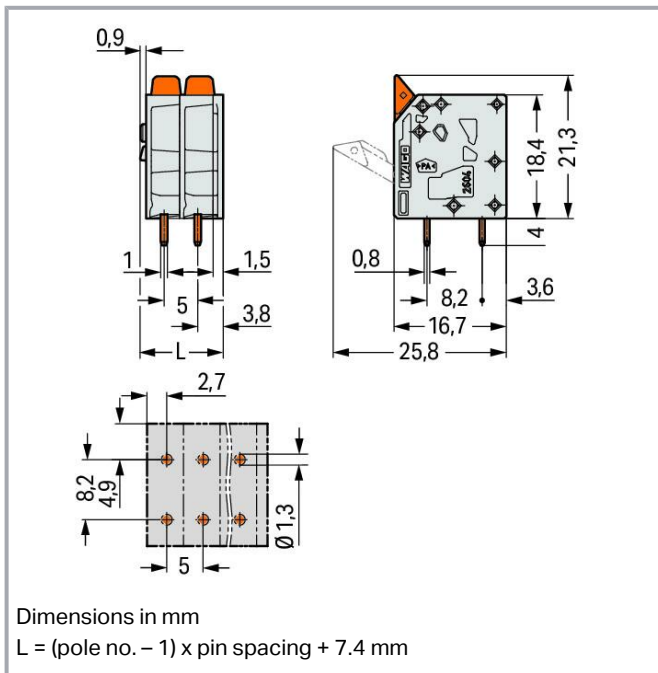

## Item description

- PCB terminal blocks with Push-in CAGE CLAMP® connection and levers
- Push-in termination of solid and ferruled conductors
- Intuitive and tool-free operation
- Several clamping units can be held open simultaneously, simplifying the connection of multi-core cables
- Testing can be performed both parallel and perpendicular to conductor entry

## Data

### Notes

Variants:

Other pole numbers

Direct marking

Other colors

Other versions (or variants) can be requested from WAGO Sales or configured at <https://configurator.wago.com/>.

## Electrical data

### Ratings per IEC/EN

Ratings per

IEC/EN 60664-1

Subject to changes. Please also observe the further product documentation!

WAGO GmbH & Co. KG

Hansastr. 27

32423 Minden

Phone: +49571 887-0 | Fax: +49571 887-169

Email: [info.de@wago.com](mailto:info.de@wago.com) | Web: [www.wago.com](http://www.wago.com)

Do you have any questions about our products?

We are always happy to take your call at +49 (571) 887-44222.



Nominal voltage (III/3)	320 V
Rated impulse voltage (III/3)	4 kV
Rated voltage (III/2)	400 V
Rated impulse voltage (III/2)	4 kV
Nominal voltage (II/2)	630 V
Rated surge voltage (II/2)	4 kV
Rated current	32 A
Legend (ratings)	(III / 2) $\triangleq$ Overvoltage category III / Pollution degree 2

### Ratings per UL

Approvals per	UL 1059
Rated voltage UL (Use Group B)	300 V
Rated current UL (Use Group B)	20 A
Rated voltage UL (Use Group D)	300 V
Rated current UL (Use Group D)	10 A

### Ratings per CSA

Approvals per	CSA
Rated voltage CSA (Use Group B)	300 V
Rated current CSA (Use Group B)	20 A
Rated voltage CSA (Use Group D)	300 V
Rated current CSA (Use Group D)	5 A

### Connection data

Connection points	8
Total number of potentials	8
Number of connection types	1
Number of levels	1

### Connection 1

Connection technology	Push-in CAGE CLAMP®
Actuation type	Lever
Solid conductor	0.2 ... 4 mm <sup>2</sup> / 24 ... 12 AWG
Fine-stranded conductor	0.2 ... 4 mm <sup>2</sup> / 24 ... 12 AWG
Fine-stranded conductor; with insulated ferrule	0.25 ... 2.5 mm <sup>2</sup>
Fine-stranded conductor; with uninsulated ferrule	0.25 ... 2.5 mm <sup>2</sup>

Subject to changes. Please also observe the further product documentation!



Fine-stranded conductor; with twin ferrule	0.25 ... 1.5 mm <sup>2</sup>
Strip length	9 ... 11 mm / 0.35 ... 0.43 inches
Conductor connection direction to PCB	90 °
Pole number	8

### Physical data

Pin spacing	5 mm / 0.197 inches
Width	42.4 mm / 1.669 inches
Height	25.3 mm / 0.996 inches
Height from the surface	21.3 mm / 0.839 inches
Depth	16.7 mm / 0.657 inches
Solder pin length	4 mm
Solder pin dimensions	0.8 x 1 mm
Drilled hole diameter with tolerance	1.3 <sup>(+0.1)</sup> mm

### PCB contact

PCB contact	THT
Solder pin arrangement	over the entire terminal strip (in-line)
Number of solder pins per potential	2

### Material data

Note (material data)	Information on material specifications can be found here
Color	gray
Material group	I
Insulation material	Polyamide (PA66)
Flammability class per UL94	V0
Clamping spring material	Chrome-nickel spring steel (CrNi)
Contact material	Electrolytic copper (E <sub>Cu</sub> )
Contact plating	Tin
Fire load	0.152 MJ
Actuator color	orange
Weight	13.2 g

Subject to changes. Please also observe the further product documentation!

## Environmental requirements

Limit temperature range	-60 ... +105 °C
Processing temperature	-35 ... +60 °C
Continuous operating temperature	-60 ... +105 °C

## Commercial data



eCl@ss 10.0	27-44-04-01
eCl@ss 9.0	27-44-04-01
ETIM 8.0	EC002643
ETIM 7.0	EC002643
ECCN	NO DATA
PU (SPU)	40 pcs
Packaging type	box
Country of origin	PL
GTIN	4066966391053
Customs tariff number	8536901000

## Environmental Product Compliance

RoHS Compliance Status	Compliant, No Exemption
------------------------	-------------------------

## Approvals / Certificates







### General approvals

Logo	Approval	Additional Approval Text	Certificate name
	<b>CB</b> DEKRA Certification B.V.	IEC 60947-7-4	NL-61583
	<b>CSA</b> DEKRA Certification B.V.	C22.2 No. 158	70117145
	<b>cURus</b> Underwriters Laboratories Inc.	UL 1059	E45172
	<b>KEMA/KEUR</b> DEKRA Certification B.V.	EN 60947-7-4	71- 100535

Subject to changes. Please also observe the further product documentation!

## Optional accessories

### Ferrule

Ferrule		
	<b>Item no.: 216-106</b> Ferrule; Sleeve for 2.5 mm <sup>2</sup> / AWG 14; uninsulated; electro-tin plated; silver-colored	<a href="http://www.wago.com/216-106">www.wago.com/216-106</a>
	<b>Item no.: 216-241</b> Ferrule; Sleeve for 0.5 mm <sup>2</sup> / 20 AWG; insulated; electro-tin plated; electrolytic copper; gastight crimped; acc. to DIN 46228, Part 4/09.90; white	<a href="http://www.wago.com/216-241">www.wago.com/216-241</a>
	<b>Item no.: 216-242</b> Ferrule; Sleeve for 0.75 mm <sup>2</sup> / 18 AWG; insulated; electro-tin plated; electrolytic copper; gastight crimped; acc. to DIN 46228, Part 4/09.90; gray	<a href="http://www.wago.com/216-242">www.wago.com/216-242</a>
	<b>Item no.: 216-243</b> Ferrule; Sleeve for 1 mm <sup>2</sup> / AWG 18; insulated; electro-tin plated; electrolytic copper; gastight crimped; acc. to DIN 46228, Part 4/09.90; red	<a href="http://www.wago.com/216-243">www.wago.com/216-243</a>
	<b>Item no.: 216-244</b> Ferrule; Sleeve for 1.5 mm <sup>2</sup> / AWG 16; insulated; electro-tin plated; electrolytic copper; gastight crimped; acc. to DIN 46228, Part 4/09.90; black	<a href="http://www.wago.com/216-244">www.wago.com/216-244</a>
	<b>Item no.: 216-246</b> Ferrule; Sleeve for 2.5 mm <sup>2</sup> / AWG 14; insulated; electro-tin plated; electrolytic copper; gastight crimped; acc. to DIN 46228, Part 4/09.90; blue	<a href="http://www.wago.com/216-246">www.wago.com/216-246</a>

## Downloads

### Documentation

#### Additional Information

Technical Section	2019 Apr 3	pdf	Download
Technical explanations		2.1 MB	

## CAD/CAE-Data

### CAD data

2D/3D Models 2604-3108	URL	Download
------------------------	-----	----------

### PCB Design

Symbol and Footprint via Ultra Librarian 2604-3108	URL	Download
--	-----	----------

CAX data for your PCB design, consisting of "schematic symbols and PCB footprints", allow easy integration of the WAGO component into your development environment.

Supported formats:

Subject to changes. Please also observe the further product documentation!



- Accel EDA 14 & 15
- Altair
- Altium 6 to current version
- Autodesk Fusion 360
- Cadence Allegro
- DesignSpark
- Eagle Libraries
- KiCad
- Mentor Graphics
- BoardStation
- Mentor Graphics Design Architect
- Mentor Graphics Design
- Expedition 99 and 2000
- OrCAD 9.X PCB and Capture
- PADS PowerPCB 3, 3.5, 4.X, and 5.X
- PADS PowerPCB and PowerLogic 3.0
- PCAD 2000, 2001, 2002, 2004, and 2006
- Pulsonix 8.5 or newer
- STL
- 3D STEP
- TARGET 3001!
- View Logic ViewDraw
- Quadcept
- Zuken CadStar 3 and 4
- Zuken CR-5000 and CR-8000
- Zuken eCADSTAR 2020 and 2021Zuken CR-5000 and CR-8000

---

PCB Component Libraries (EDA), PCB CAD Library Ultra Librarian

Symbol and Footprint via SamacSys 2604-3108

[URL](#)

[Download](#)

CAX data for your PCB design, consisting of "schematic symbols and PCB footprints", allow easy integration of the WAGO component into your development environment.

Supported formats:

- 3D (stp)
- Altium
- CADSTAR

—  
Subject to changes. Please also observe the further product documentation!

---

WAGO GmbH & Co. KG

Hansastr. 27

32423 Minden

Phone: +49571 887-0 | Fax: +49571 887-169

Email: [info.de@wago.com](mailto:info.de@wago.com) | Web: [www.wago.com](http://www.wago.com)

Do you have any questions about our products?

We are always happy to take your call at +49 (571) 887-44222.



- Capture
- CircuitStudio
- CR-5000
- CR-8000
- DEHDL
- DesignSpark PCB
- DesignSpark PCB PRO
- DipTrace
- EAGLE
- Easy-PC
- EasyEDA
- eCADSTAR
- KiCad
- OrCAD\_Allegro16
- PADS
- Proteus
- Pulsonix
- Quadcept
- SOLIDWORKS PCB
- TARGET 3001!
- xDX Designer
- Xpedition

PCB Component Libraries (EDA), PCB CAD Library SamacSys Electronic Component Search Engine

---

#### CAE data

ZUKEN Portal 2604-3108	<a href="#">URL</a>	<a href="#">Download</a>
------------------------	---------------------	--------------------------

---

#### Asset Administration Shell

Asset Administration Shell 2604-3108	<a href="#">URL</a>	<a href="#">Download</a>
--------------------------------------	---------------------	--------------------------

---

#### Environmental Product Compliance

##### Compliance Search

Environmental Product Compliance 2604-3108	<a href="#">URL</a>	<a href="#">Download</a>
--	---------------------	--------------------------

Subject to changes. Please also observe the further product documentation!

---

WAGO GmbH & Co. KG  
Hansastr. 27  
32423 Minden  
Phone: +49571 887-0 | Fax: +49571 887-169  
Email: [info.de@wago.com](mailto:info.de@wago.com) | Web: [www.wago.com](http://www.wago.com)

Do you have any questions about our products?  
We are always happy to take your call at +49 (571) 887-44222.



PCB terminal block; lever; 4 mm<sup>2</sup>; Pin spacing 5 mm; 8-pole; Push-in CAGE CLAMP®;  
4,00 mm<sup>2</sup>; gray

---

## Installation Notes

### Conductor termination

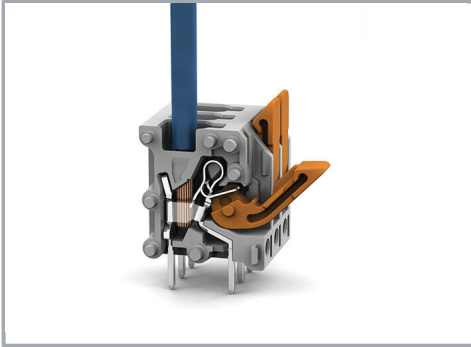

Insert fine-stranded conductors – and remove all conductors – via operating tool.

### Conductor termination

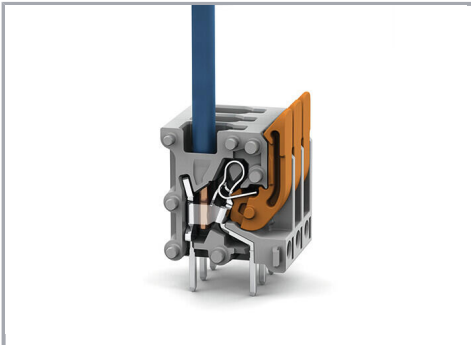

Insert solid conductors via push-in termination.

Subject to changes. Please also observe the further product documentation!