

## Data sheet | Item number: 806-206

2-conductor female connector; 1.5 mm<sup>2</sup>; Pin spacing 5 mm; 6-pole; 1,50 mm<sup>2</sup>; gray

[www.wago.com/806-206](http://www.wago.com/806-206)



Color:

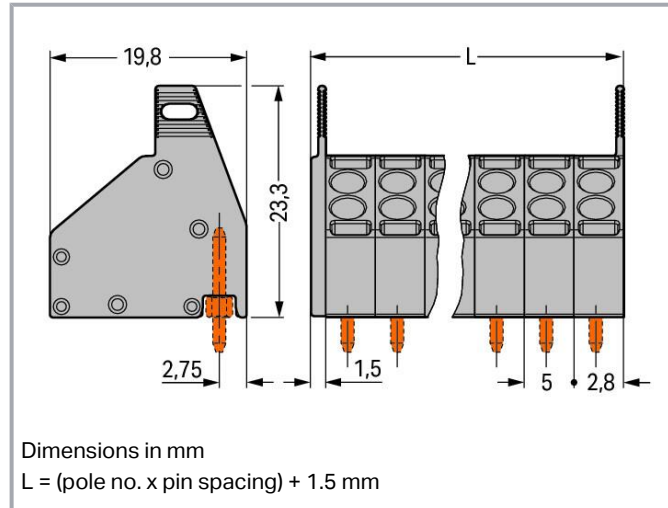

### Item description

- 2-conductor female connector with Push-in CAGE CLAMP<sup>®</sup> and screwdriver actuation
- Push-in termination of solid and ferruled conductors
- Double entries for power supply and potential distribution
- Quick and easy PCB replacement, without disrupting looped-through potentials

### Data

#### Notes

Variants:

Other pole numbers

Other colors

Mixed-color PCB connector strips

Direct marking

Other versions (or variants) can be requested from WAGO Sales or configured at <https://configurator.wago.com/>.

Subject to changes. Please also observe the further product documentation!

WAGO GmbH & Co. KG

Hansastr. 27

32423 Minden

Phone: +49571 887-0 | Fax: +49571 887-169

Email: [info.de@wago.com](mailto:info.de@wago.com) | Web: [www.wago.com](http://www.wago.com)

Do you have any questions about our products?

We are always happy to take your call at +49 (571) 887-44222.

## Electrical data

### Ratings per IEC/EN

Ratings per	IEC/EN 60664-1
Nominal voltage (III/3)	250 V
Rated impulse voltage (III/3)	4 kV
Rated voltage (III/2)	320 V
Rated impulse voltage (III/2)	4 kV
Nominal voltage (II/2)	630 V
Rated surge voltage (II/2)	4 kV
Rated current	10 A
Legend (ratings)	(III / 2) ≙ Overvoltage category III / Pollution degree 2

### Ratings per UL

Approvals per	UL 1059
Rated voltage UL (Use Group B)	300 V
Rated current UL (Use Group B)	10 A
Rated voltage UL (Use Group D)	300 V
Rated current UL (Use Group D)	10 A

### Ratings per CSA

Approvals per	CSA
Rated voltage CSA (Use Group B)	300 V
Rated current CSA (Use Group B)	10 A

### Connection data

Connection points	12
Total number of potentials	6
Number of connection types	1
Number of levels	1

### Connection 1

Connection technology	Push-in CAGE CLAMP®
Actuation type	Operating tool
Solid conductor	0.2 ... 1.5 mm <sup>2</sup> / 24 ... 16 AWG

Subject to changes. Please also observe the further product documentation!



Fine-stranded conductor	0.2 ... 1.5 mm <sup>2</sup> / 24 ... 16 AWG
Fine-stranded conductor; with insulated ferrule	0.25 ... 1 mm <sup>2</sup>
Fine-stranded conductor; with uninsulated ferrule	0.25 ... 1 mm <sup>2</sup>
Strip length	9 ... 10 mm / 0.35 ... 0.39 inches
Conductor connection direction to PCB	45 °
Pole number	6

### Physical data

Pin spacing	5 mm / 0.197 inches
Width	31.5 mm / 1.24 inches
Height	23.3 mm / 0.917 inches
Depth	19.8 mm / 0.78 inches
Solder pin diameter	1 mm

### Plug-in connection

Contact type (pluggable connector)	Female connector/socket
Connector (connection type)	for PCB
Mating direction to the PCB	90 °

### Material data

Note (material data)	Information on material specifications can be found here
Color	gray
Material group	I
Insulation material	Polyamide (PA66)
Flammability class per UL94	V0
Clamping spring material	Chrome-nickel spring steel (CrNi)
Contact material	Copper alloy
Contact plating	Tin
Fire load	0.156 MJ
Weight	7.8 g

### Environmental requirements

Limit temperature range	-60 ... +105 °C
-------------------------	-----------------

Subject to changes. Please also observe the further product documentation!

## Commercial data





Product Group	4 (Printed Circuit Connectors)
eCl@ss 10.0	27-44-04-01
eCl@ss 9.0	27-44-04-01
ETIM 8.0	EC002643
ETIM 7.0	EC002643
ECCN	NO DATA
PU (SPU)	220 pcs
Packaging type	box
Country of origin	PL
GTIN	4045454077112
Customs tariff number	85366990990

## Environmental Product Compliance

RoHS Compliance Status	Compliant, No Exemption
------------------------	-------------------------

## Approvals / Certificates

### General approvals

Logo	Approval	Additional Approval Text	Certificate name
	CCA DEKRA Certification B.V.	EN 60947-7-4	NTR NL-7808
	CCA DEKRA Certification B.V.	EN 60947-7-4	71-112254
	CSA DEKRA Certification B.V.	C22.2	1132097
	UR Underwriters Laboratories Inc.	UL 1059	E45172

Subject to changes. Please also observe the further product documentation!

## Required accessories

### Male connector

Solder pin

**Item no.: 806-906**













THT pin strip; straight; Pin spacing 5 mm; 6-pole; black

[www.wago.com/806-906](http://www.wago.com/806-906)

## Optional accessories

### Ferrule

Ferrule

	<b>Item no.: 216-101</b> Ferrule; Sleeve for 0.5 mm <sup>2</sup> / AWG 22; uninsulated; electro-tin plated; silver-colored	<a href="http://www.wago.com/216-101">www.wago.com/216-101</a>
	<b>Item no.: 216-102</b> Ferrule; Sleeve for 0.75 mm <sup>2</sup> / AWG 20; uninsulated; electro-tin plated; silver-colored	<a href="http://www.wago.com/216-102">www.wago.com/216-102</a>
	<b>Item no.: 216-103</b> Ferrule; Sleeve for 1 mm <sup>2</sup> / AWG 18; uninsulated; electro-tin plated	<a href="http://www.wago.com/216-103">www.wago.com/216-103</a>
	<b>Item no.: 216-123</b> Ferrule; Sleeve for 1 mm <sup>2</sup> / AWG 18; uninsulated; electro-tin plated; silver-colored	<a href="http://www.wago.com/216-123">www.wago.com/216-123</a>
	<b>Item no.: 216-122</b> Ferrule; Sleeve for 0.75 mm <sup>2</sup> / AWG 20; uninsulated; electro-tin plated; silver-colored	<a href="http://www.wago.com/216-122">www.wago.com/216-122</a>
	<b>Item no.: 216-142</b> Ferrule; Sleeve for 0.75 mm <sup>2</sup> / 18 AWG; uninsulated; electro-tin plated; electrolytic copper; gastight crimped; acc. to DIN 46228, Part 1/08.92	<a href="http://www.wago.com/216-142">www.wago.com/216-142</a>
	<b>Item no.: 216-132</b> Ferrule; Sleeve for 0.34 mm <sup>2</sup> / AWG 24; uninsulated; electro-tin plated	<a href="http://www.wago.com/216-132">www.wago.com/216-132</a>
	<b>Item no.: 216-121</b> Ferrule; Sleeve for 0.5 mm <sup>2</sup> / AWG 22; uninsulated; electro-tin plated; silver-colored	<a href="http://www.wago.com/216-121">www.wago.com/216-121</a>
	<b>Item no.: 216-143</b> Ferrule; Sleeve for 1 mm <sup>2</sup> / AWG 18; uninsulated; electro-tin plated; electrolytic copper; gastight crimped; acc. to DIN 46228, Part 1/08.92	<a href="http://www.wago.com/216-143">www.wago.com/216-143</a>
	<b>Item no.: 216-131</b> Ferrule; Sleeve for 0.25 mm <sup>2</sup> / AWG 24; uninsulated; electro-tin plated; silver-colored	<a href="http://www.wago.com/216-131">www.wago.com/216-131</a>
	<b>Item no.: 216-141</b> Ferrule; Sleeve for 0.5 mm <sup>2</sup> / 20 AWG; uninsulated; electro-tin plated; electrolytic copper; gastight crimped; acc. to DIN 46228, Part 1/08.92	<a href="http://www.wago.com/216-141">www.wago.com/216-141</a>
	<b>Item no.: 216-152</b> Ferrule; Sleeve for 0.34 mm <sup>2</sup> / AWG 24; uninsulated; electro-tin plated	<a href="http://www.wago.com/216-152">www.wago.com/216-152</a>
	<b>Item no.: 216-203</b> Ferrule; Sleeve for 1 mm <sup>2</sup> / AWG 18; insulated; electro-tin plated; red	<a href="http://www.wago.com/216-203">www.wago.com/216-203</a>

Subject to changes. Please also observe the further product documentation!

	<b>Item no.: 216-202</b> Ferrule; Sleeve for 0.75 mm <sup>2</sup> / 18 AWG; insulated; electro-tin plated; gray	<a href="http://www.wago.com/216-202">www.wago.com/216-202</a>
	<b>Item no.: 216-151</b> Ferrule; Sleeve for 0.25 mm <sup>2</sup> / AWG 24; uninsulated; electro-tin plated	<a href="http://www.wago.com/216-151">www.wago.com/216-151</a>
	<b>Item no.: 216-201</b> Ferrule; Sleeve for 0.5 mm <sup>2</sup> / 20 AWG; insulated; electro-tin plated; white	<a href="http://www.wago.com/216-201">www.wago.com/216-201</a>
	<b>Item no.: 216-223</b> Ferrule; Sleeve for 1 mm <sup>2</sup> / AWG 18; insulated; electro-tin plated; red	<a href="http://www.wago.com/216-223">www.wago.com/216-223</a>
	<b>Item no.: 216-241</b> Ferrule; Sleeve for 0.5 mm <sup>2</sup> / 20 AWG; insulated; electro-tin plated; electrolytic copper; gastight crimped; acc. to DIN 46228, Part 4/09.90; white	<a href="http://www.wago.com/216-241">www.wago.com/216-241</a>
	<b>Item no.: 216-242</b> Ferrule; Sleeve for 0.75 mm <sup>2</sup> / 18 AWG; insulated; electro-tin plated; electrolytic copper; gastight crimped; acc. to DIN 46228, Part 4/09.90; gray	<a href="http://www.wago.com/216-242">www.wago.com/216-242</a>
	<b>Item no.: 216-222</b> Ferrule; Sleeve for 0.75 mm <sup>2</sup> / 18 AWG; insulated; electro-tin plated; gray	<a href="http://www.wago.com/216-222">www.wago.com/216-222</a>
	<b>Item no.: 216-221</b> Ferrule; Sleeve for 0.5 mm <sup>2</sup> / 20 AWG; insulated; electro-tin plated; white	<a href="http://www.wago.com/216-221">www.wago.com/216-221</a>
	<b>Item no.: 216-243</b> Ferrule; Sleeve for 1 mm <sup>2</sup> / AWG 18; insulated; electro-tin plated; electrolytic copper; gastight crimped; acc. to DIN 46228, Part 4/09.90; red	<a href="http://www.wago.com/216-243">www.wago.com/216-243</a>
	<b>Item no.: 216-263</b> Ferrule; Sleeve for 1 mm <sup>2</sup> / AWG 18; insulated; electro-tin plated; electrolytic copper; gastight crimped; acc. to DIN 46228, Part 4/09.90; red	<a href="http://www.wago.com/216-263">www.wago.com/216-263</a>
	<b>Item no.: 216-264</b> Ferrule; Sleeve for 1.5 mm <sup>2</sup> / AWG 16; insulated; electro-tin plated; electrolytic copper; gastight crimped; acc. to DIN 46228, Part 4/09.90; black	<a href="http://www.wago.com/216-264">www.wago.com/216-264</a>
	<b>Item no.: 216-262</b> Ferrule; Sleeve for 0.75 mm <sup>2</sup> / 18 AWG; insulated; electro-tin plated; electrolytic copper; gastight crimped; acc. to DIN 46228, Part 4/09.90; gray	<a href="http://www.wago.com/216-262">www.wago.com/216-262</a>
	<b>Item no.: 216-301</b> Ferrule; Sleeve for 0.25 mm <sup>2</sup> / AWG 24; insulated; electro-tin plated; yellow	<a href="http://www.wago.com/216-301">www.wago.com/216-301</a>
	<b>Item no.: 216-321</b> Ferrule; Sleeve for 0.25 mm <sup>2</sup> / AWG 24; insulated; electro-tin plated; yellow	<a href="http://www.wago.com/216-321">www.wago.com/216-321</a>
	<b>Item no.: 216-322</b> Ferrule; Sleeve for 0.34 mm <sup>2</sup> / 22 AWG; insulated; electro-tin plated; light turquoise	<a href="http://www.wago.com/216-322">www.wago.com/216-322</a>
	<b>Item no.: 216-302</b> Ferrule; Sleeve for 0.34 mm <sup>2</sup> / 22 AWG; insulated; electro-tin plated; light turquoise	<a href="http://www.wago.com/216-302">www.wago.com/216-302</a>



**Marking accessories**

Marking strip

Subject to changes. Please also observe the further product documentation!

	<b>Item no.: 210-332/500-202</b> Marking strips; as a DIN A4 sheet; MARKED; 1-16 (160x); Height of marker strip: 3 mm; Strip length 182 mm; Horizontal marking; Self-adhesive; white	<a href="http://www.wago.com/210-332/500-202">www.wago.com/210-332/500-202</a>
	<b>Item no.: 210-332/500-206</b> Marking strips; as a DIN A4 sheet; MARKED; 33-48 (160x); Height of marker strip: 3 mm; Strip length 182 mm; Horizontal marking; Self-adhesive; white	<a href="http://www.wago.com/210-332/500-206">www.wago.com/210-332/500-206</a>
	<b>Item no.: 210-332/500-205</b> Marking strips; as a DIN A4 sheet; MARKED; 1-32 (80x); Height of marker strip: 3 mm; Strip length 182 mm; Horizontal marking; Self-adhesive; white	<a href="http://www.wago.com/210-332/500-205">www.wago.com/210-332/500-205</a>
	<b>Item no.: 210-332/500-204</b> Marking strips; as a DIN A4 sheet; MARKED; 17-32 (160x); Height of marker strip: 3 mm; Strip length 182 mm; Horizontal marking; Self-adhesive; white	<a href="http://www.wago.com/210-332/500-204">www.wago.com/210-332/500-204</a>

## Tool

Operating tool		
	<b>Item no.: 210-657</b> Operating tool; Blade: 3.5 x 0.5 mm; with a partially insulated shaft; short; multicoloured	<a href="http://www.wago.com/210-657">www.wago.com/210-657</a>
	<b>Item no.: 210-720</b> Operating tool; Blade: 3.5 x 0.5 mm; with a partially insulated shaft; multicoloured	<a href="http://www.wago.com/210-720">www.wago.com/210-720</a>

## Downloads

### Documentation

#### Additional Information

Technical Section	2019 Apr 3	pdf	Download
Technical explanations		2.1 MB	

## CAD/CAE-Data

### CAD data

2D/3D Models 806-206	URL	Download
----------------------	-----	----------

### CAE data

EPLAN Data Portal 806-206	URL	Download
---------------------------	-----	----------

ZUKEN Portal 806-206	URL	Download
----------------------	-----	----------

## PCB Design

Subject to changes. Please also observe the further product documentation!



[URL](#)

[Download](#)

### Symbol and Footprint 806-206

CAX data for your PCB design, consisting of "schematic symbols and PCB footprints", allow easy integration of the WAGO component into your development environment.

### Supported formats:

- Accel EDA 14 & 15
- Altium 6 to current version
- Cadence Allegro
- DesignSpark
- Eagle Libraries
- KiCad
- Mentor Graphics BoardStation
- Mentor Graphics Design Architect
- Mentor Graphics Design Expedition 99 and 2000
- OrCAD 9.X PCB and Capture
- PADS PowerPCB 3, 3.5, 4.X, and 5.X
- PADS PowerPCB and PowerLogic 3.0
- PCAD 2000, 2001, 2002, 2004, and 2006
- Pulsonix 8.5 or newer
- STL
- 3D STEP
- TARGET 3001!
- View Logic ViewDraw
- Quadcept
- Zuken CadStar 3 and 4
- Zuken CR-5000 and CR-8000

PCB Component Libraries (EDA), PCB CAD Library Ultra Librarian

---

### Asset Administration Shell

Asset Administration Shell 806-206

[URL](#)

[Download](#)

---

### Environmental Product Compliance

#### Compliance Search

Environmental Product Compliance 806-206

[URL](#)

[Download](#)

2-conductor female connector; 1.5 mm<sup>2</sup>; Pin spacing 5 mm; 6-pole; 1,50 mm<sup>2</sup>; gray

---

Subject to changes. Please also observe the further product documentation!

---

WAGO GmbH & Co. KG

Hansastr. 27

32423 Minden

Phone: +49571 887-0 | Fax: +49571 887-169

Email: [info.de@wago.com](mailto:info.de@wago.com) | Web: [www.wago.com](http://www.wago.com)

Do you have any questions about our products?

We are always happy to take your call at +49 (571) 887-44222.



## Installation Notes

### Conductor termination

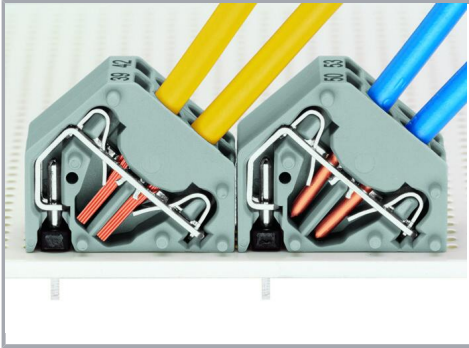

Inserting solid conductors via push-in termination.

Inserting/removing fine-stranded conductors:  
Open the clamping unit using a screwdriver and insert a stripped conductor until it hits the backstop.

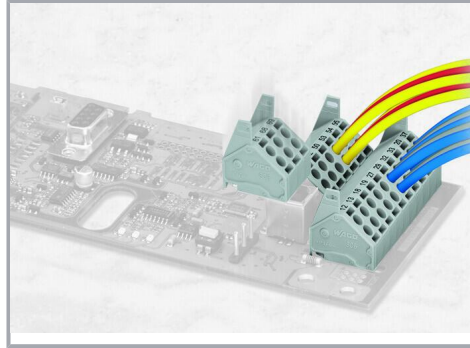

Conductor termination directly on the PCB or wiring prior to mounting on PCB

Subject to changes. Please also observe the further product documentation!