

Data sheet | Item number: 806-210

2-conductor female connector; 1.5 mm²; Pin spacing 5 mm; 10-pole; 1,50 mm²; gray

www.wago.com/806-210

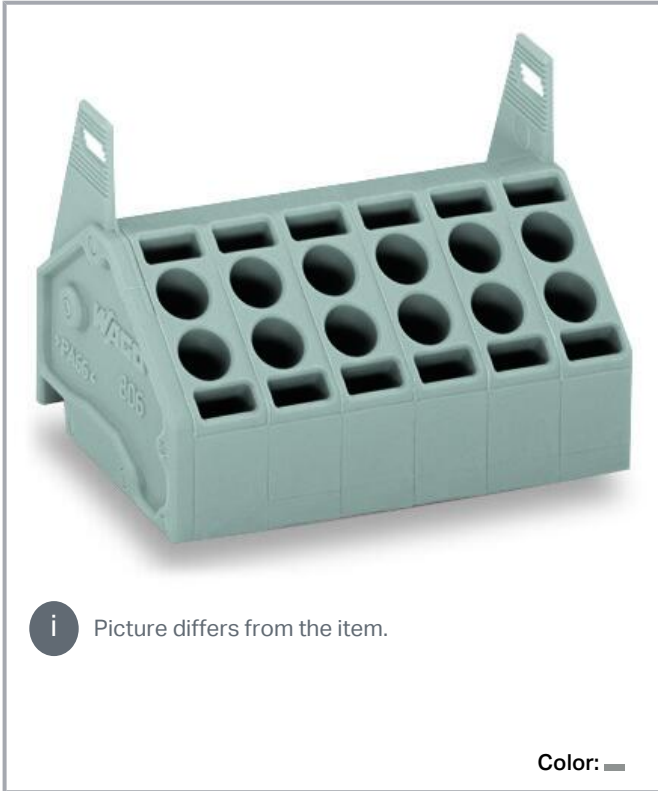

i Picture differs from the item.

Color:

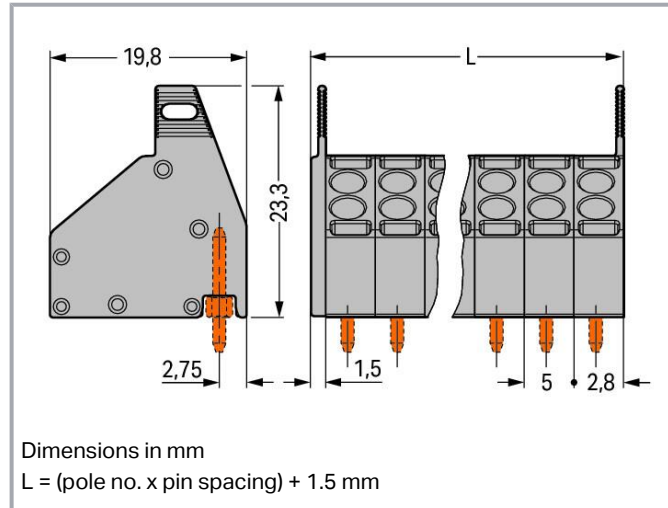

Item description

- 2-conductor female connector with Push-in CAGE CLAMP[®] and screwdriver actuation
- Push-in termination of solid and ferruled conductors
- Double entries for power supply and potential distribution
- Quick and easy PCB replacement, without disrupting looped-through potentials

Data

Notes

Variants:

Other pole numbers

Other colors

Mixed-color PCB connector strips

Direct marking

Subject to changes. Please also observe the further product documentation!

WAGO GmbH & Co. KG

Hansastr. 27

32423 Minden

Phone: +49571 887-0 | Fax: +49571 887-169

Email: info.de@wago.com | Web: www.wago.com

Do you have any questions about our products?

We are always happy to take your call at +49 (571) 887-44222.

Other versions (or variants) can be requested from WAGO Sales or configured at <https://configurator.wago.com/>.

Electrical data

Ratings per IEC/EN

Ratings per	IEC/EN 60664-1
Nominal voltage (III/3)	250 V
Rated impulse voltage (III/3)	4 kV
Rated voltage (III/2)	320 V
Rated impulse voltage (III/2)	4 kV
Nominal voltage (II/2)	630 V
Rated surge voltage (II/2)	4 kV
Rated current	10 A
Legend (ratings)	(III / 2) $\hat{=}$ Overvoltage category III / Pollution degree 2

Ratings per UL

Approvals per	UL 1059
Rated voltage UL (Use Group B)	300 V
Rated current UL (Use Group B)	10 A
Rated voltage UL (Use Group D)	300 V
Rated current UL (Use Group D)	10 A

Ratings per CSA

Approvals per	CSA
Rated voltage CSA (Use Group B)	300 V
Rated current CSA (Use Group B)	10 A

Connection data

Connection points	20
Total number of potentials	10
Number of connection types	1
Number of levels	1

Connection 1

Connection technology	Push-in CAGE CLAMP®
-----------------------	---------------------

Subject to changes. Please also observe the further product documentation!



Actuation type	Operating tool
Solid conductor	0.2 ... 1.5 mm ² / 24 ... 16 AWG
Fine-stranded conductor	0.2 ... 1.5 mm ² / 24 ... 16 AWG
Fine-stranded conductor; with insulated ferrule	0.25 ... 1 mm ²
Fine-stranded conductor; with uninsulated ferrule	0.25 ... 1 mm ²
Strip length	9 ... 10 mm / 0.35 ... 0.39 inches
Conductor connection direction to PCB	45 °
Pole number	10

Physical data

Pin spacing	5 mm / 0.197 inches
Width	51.5 mm / 2.028 inches
Height	23.3 mm / 0.917 inches
Depth	19.8 mm / 0.78 inches
Solder pin diameter	1 mm

Plug-in connection

Contact type (pluggable connector)	Female connector/socket
Connector (connection type)	for PCB
Mating direction to the PCB	90 °

Material data

Note (material data)	Information on material specifications can be found here
Color	gray
Material group	I
Insulation material	Polyamide (PA66)
Flammability class per UL94	V0
Clamping spring material	Chrome-nickel spring steel (CrNi)
Contact material	Copper alloy
Contact plating	Tin
Fire load	0.252 MJ
Weight	12.7 g

Environmental requirements

Limit temperature range	-60 ... +105 °C
-------------------------	-----------------

Subject to changes. Please also observe the further product documentation!

Commercial data





Product Group	4 (Printed Circuit Connectors)
eCl@ss 10.0	27-44-04-01
eCl@ss 9.0	27-44-04-01
ETIM 8.0	EC002643
ETIM 7.0	EC002643
ECCN	NO DATA
PU (SPU)	132 pcs
Packaging type	box
Country of origin	PL
GTIN	4045454077181
Customs tariff number	85366990990

Environmental Product Compliance

RoHS Compliance Status	Compliant, No Exemption
------------------------	-------------------------

Approvals / Certificates

General approvals

Logo	Approval	Additional Approval Text	Certificate name
	CCA DEKRA Certification B.V.	EN 60947-7-4	NTR NL-7808
	CCA DEKRA Certification B.V.	EN 60947-7-4	71-112254
	CSA DEKRA Certification B.V.	C22.2	1132097
	UR Underwriters Laboratories Inc.	UL 1059	E45172

Subject to changes. Please also observe the further product documentation!

Required accessories

Male connector

Solder pin

**Item no.: 806-910**

THT pin strip; straight; Pin spacing 5 mm; 10-pole; black

www.wago.com/806-910

Optional accessories

Marking accessories

Marking strip

**Item no.: 210-332/500-202**

Marking strips; as a DIN A4 sheet; MARKED; 1-16 (160x); Height of marker strip: 3 mm; Strip length 182 mm; Horizontal marking; Self-adhesive; white

www.wago.com/210-332/500-202**Item no.: 210-332/500-206**

Marking strips; as a DIN A4 sheet; MARKED; 33-48 (160x); Height of marker strip: 3 mm; Strip length 182 mm; Horizontal marking; Self-adhesive; white

www.wago.com/210-332/500-206**Item no.: 210-332/500-205**

Marking strips; as a DIN A4 sheet; MARKED; 1-32 (80x); Height of marker strip: 3 mm; Strip length 182 mm; Horizontal marking; Self-adhesive; white

www.wago.com/210-332/500-205**Item no.: 210-332/500-204**

Marking strips; as a DIN A4 sheet; MARKED; 17-32 (160x); Height of marker strip: 3 mm; Strip length 182 mm; Horizontal marking; Self-adhesive; white

www.wago.com/210-332/500-204

Tool

Operating tool

**Item no.: 210-657**

Operating tool; Blade: 3.5 x 0.5 mm; with a partially insulated shaft; short; multicoloured

www.wago.com/210-657**Item no.: 210-720**

Operating tool; Blade: 3.5 x 0.5 mm; with a partially insulated shaft; multicoloured

www.wago.com/210-720

Ferrule

Ferrule

**Item no.: 216-101**Ferrule; Sleeve for 0.5 mm² / AWG 22; uninsulated; electro-tin plated; silver-coloredwww.wago.com/216-101**Item no.: 216-102**Ferrule; Sleeve for 0.75 mm² / AWG 20; uninsulated; electro-tin plated; silver-coloredwww.wago.com/216-102**Item no.: 216-103**Ferrule; Sleeve for 1 mm² / AWG 18; uninsulated; electro-tin platedwww.wago.com/216-103**Item no.: 216-123**Ferrule; Sleeve for 1 mm² / AWG 18; uninsulated; electro-tin plated; silver-coloredwww.wago.com/216-123

Subject to changes. Please also observe the further product documentation!

WAGO GmbH & Co. KG

Hansastr. 27

32423 Minden

Phone: +49571 887-0 | Fax: +49571 887-169

Email: info.de@wago.com | Web: www.wago.com

Do you have any questions about our products?



We are always happy to take your call at +49 (571) 887-44222.



Item no.: 216-122 Ferrule; Sleeve for 0.75 mm ² / AWG 20; uninsulated; electro-tin plated; silver-colored	www.wago.com/216-122
Item no.: 216-142 Ferrule; Sleeve for 0.75 mm ² / 18 AWG; uninsulated; electro-tin plated; electrolytic copper; gastight crimped; acc. to DIN 46228, Part 1/08.92	www.wago.com/216-142
Item no.: 216-132 Ferrule; Sleeve for 0.34 mm ² / AWG 24; uninsulated; electro-tin plated	www.wago.com/216-132
Item no.: 216-121 Ferrule; Sleeve for 0.5 mm ² / AWG 22; uninsulated; electro-tin plated; silver-colored	www.wago.com/216-121
Item no.: 216-143 Ferrule; Sleeve for 1 mm ² / AWG 18; uninsulated; electro-tin plated; electrolytic copper; gastight crimped; acc. to DIN 46228, Part 1/08.92	www.wago.com/216-143
Item no.: 216-131 Ferrule; Sleeve for 0.25 mm ² / AWG 24; uninsulated; electro-tin plated; silver-colored	www.wago.com/216-131
Item no.: 216-141 Ferrule; Sleeve for 0.5 mm ² / 20 AWG; uninsulated; electro-tin plated; electrolytic copper; gastight crimped; acc. to DIN 46228, Part 1/08.92	www.wago.com/216-141
Item no.: 216-152 Ferrule; Sleeve for 0.34 mm ² / AWG 24; uninsulated; electro-tin plated	www.wago.com/216-152
Item no.: 216-203 Ferrule; Sleeve for 1 mm ² / AWG 18; insulated; electro-tin plated; red	www.wago.com/216-203
Item no.: 216-202 Ferrule; Sleeve for 0.75 mm ² / 18 AWG; insulated; electro-tin plated; gray	www.wago.com/216-202
Item no.: 216-151 Ferrule; Sleeve for 0.25 mm ² / AWG 24; uninsulated; electro-tin plated	www.wago.com/216-151
Item no.: 216-201 Ferrule; Sleeve for 0.5 mm ² / 20 AWG; insulated; electro-tin plated; white	www.wago.com/216-201
Item no.: 216-223 Ferrule; Sleeve for 1 mm ² / AWG 18; insulated; electro-tin plated; red	www.wago.com/216-223
Item no.: 216-241 Ferrule; Sleeve for 0.5 mm ² / 20 AWG; insulated; electro-tin plated; electrolytic copper; gastight crimped; acc. to DIN 46228, Part 4/09.90; white	www.wago.com/216-241
Item no.: 216-242 Ferrule; Sleeve for 0.75 mm ² / 18 AWG; insulated; electro-tin plated; electrolytic copper; gastight crimped; acc. to DIN 46228, Part 4/09.90; gray	www.wago.com/216-242
Item no.: 216-222 Ferrule; Sleeve for 0.75 mm ² / 18 AWG; insulated; electro-tin plated; gray	www.wago.com/216-222
Item no.: 216-221 Ferrule; Sleeve for 0.5 mm ² / 20 AWG; insulated; electro-tin plated; white	www.wago.com/216-221
Item no.: 216-243	

Subject to changes. Please also observe the further product documentation!



	Ferrule; Sleeve for 1 mm ² / AWG 18; insulated; electro-tin plated; electrolytic copper; gastight crimped; acc. to DIN 46228, Part 4/09.90; red	www.wago.com/216-243
	Item no.: 216-263 Ferrule; Sleeve for 1 mm ² / AWG 18; insulated; electro-tin plated; electrolytic copper; gastight crimped; acc. to DIN 46228, Part 4/09.90; red	www.wago.com/216-263
	Item no.: 216-264 Ferrule; Sleeve for 1.5 mm ² / AWG 16; insulated; electro-tin plated; electrolytic copper; gastight crimped; acc. to DIN 46228, Part 4/09.90; black	www.wago.com/216-264
	Item no.: 216-262 Ferrule; Sleeve for 0.75 mm ² / 18 AWG; insulated; electro-tin plated; electrolytic copper; gastight crimped; acc. to DIN 46228, Part 4/09.90; gray	www.wago.com/216-262
	Item no.: 216-301 Ferrule; Sleeve for 0.25 mm ² / AWG 24; insulated; electro-tin plated; yellow	www.wago.com/216-301
	Item no.: 216-321 Ferrule; Sleeve for 0.25 mm ² / AWG 24; insulated; electro-tin plated; yellow	www.wago.com/216-321
	Item no.: 216-322 Ferrule; Sleeve for 0.34 mm ² / 22 AWG; insulated; electro-tin plated; light turquoise	www.wago.com/216-322
	Item no.: 216-302 Ferrule; Sleeve for 0.34 mm ² / 22 AWG; insulated; electro-tin plated; light turquoise	www.wago.com/216-302

Downloads

Documentation

Additional Information

Technical Section	2019 Apr 3	pdf	Download
Technical explanations		2.1 MB	

CAD/CAE-Data

CAD data

2D/3D Models 806-210	URL	Download
----------------------	-----	----------

PCB Design

Symbol and Footprint 806-210	URL	Download
------------------------------	-----	----------

CAX data for your PCB design, consisting of "schematic symbols and PCB footprints", allow easy integration of the WAGO component into your development environment.

Supported formats:

- Accel EDA 14 & 15

Subject to changes. Please also observe the further product documentation!

WAGO GmbH & Co. KG
Hansastr. 27
32423 Minden
Phone: +49571 887-0 | Fax: +49571 887-169
Email: info.de@wago.com | Web: www.wago.com

Do you have any questions about our products?
We are always happy to take your call at +49 (571) 887-44222.



- Altium 6 to current version
- Cadence Allegro
- DesignSpark
- Eagle Libraries
- KiCad
- Mentor Graphics BoardStation
- Mentor Graphics Design Architect
- Mentor Graphics Design Expedition 99 and 2000
- OrCAD 9.X PCB and Capture
- PADS PowerPCB 3, 3.5, 4.X, and 5.X
- PADS PowerPCB and PowerLogic 3.0
- PCAD 2000, 2001, 2002, 2004, and 2006
- Pulsonix 8.5 or newer
- STL
- 3D STEP
- TARGET 3001!
- View Logic ViewDraw
- Quadcept
- Zuken CadStar 3 and 4
- Zuken CR-5000 and CR-8000

PCB Component Libraries (EDA), PCB CAD Library Ultra Librarian

CAE data

ZUKEN Portal 806-210	URL	Download
----------------------	---------------------	--------------------------

Asset Administration Shell

Asset Administration Shell 806-210	URL	Download
------------------------------------	---------------------	--------------------------

Environmental Product Compliance

Compliance Search

Environmental Product Compliance 806-210	URL	Download
--	---------------------	--------------------------

2-conductor female connector; 1.5 mm²; Pin spacing 5 mm; 10-pole; 1,50 mm²; gray

Installation Notes

Subject to changes. Please also observe the further product documentation!

WAGO GmbH & Co. KG
Hansastr. 27
32423 Minden
Phone: +49571 887-0 | Fax: +49571 887-169
Email: info.de@wago.com | Web: www.wago.com

Do you have any questions about our products?
We are always happy to take your call at +49 (571) 887-44222.

Conductor termination

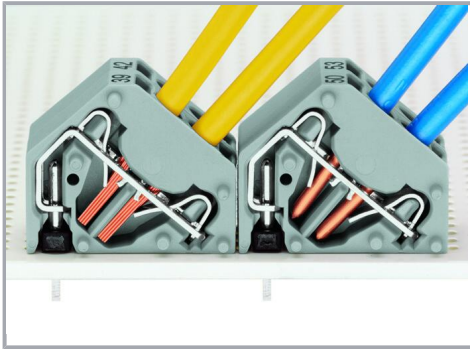

Inserting solid conductors via push-in termination.

Inserting/removing fine-stranded conductors:
Open the clamping unit using a screwdriver
and insert a stripped conductor until it hits the
backstop.

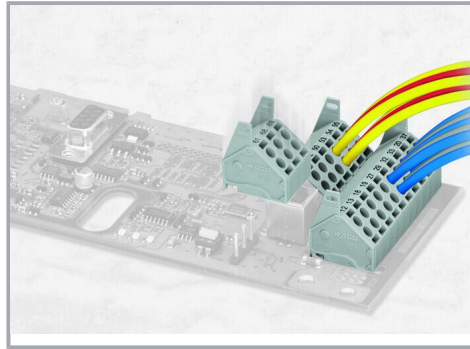

Conductor termination directly on the PCB or
wiring prior to mounting on PCB

Subject to changes. Please also observe the further product documentation!