

Data sheet | Item number: 2604-3306

PCB terminal block; lever; 4 mm<sup>2</sup>; Pin spacing 7.5 mm; 6-pole; Push-in CAGE CLAMP®; 4,00 mm<sup>2</sup>; gray

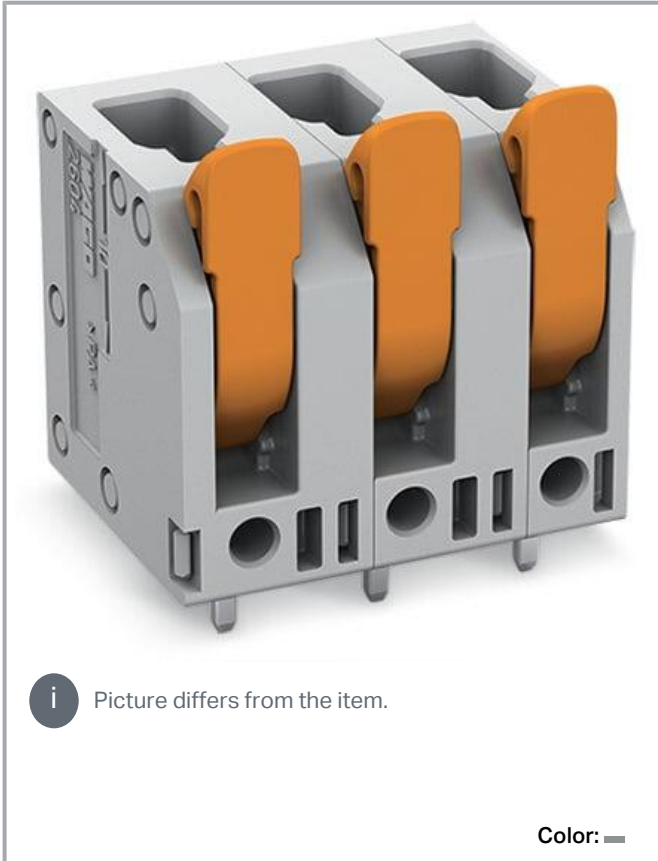

[www.wago.com/2604-3306](http://www.wago.com/2604-3306)



**i** Picture differs from the item.

Color:

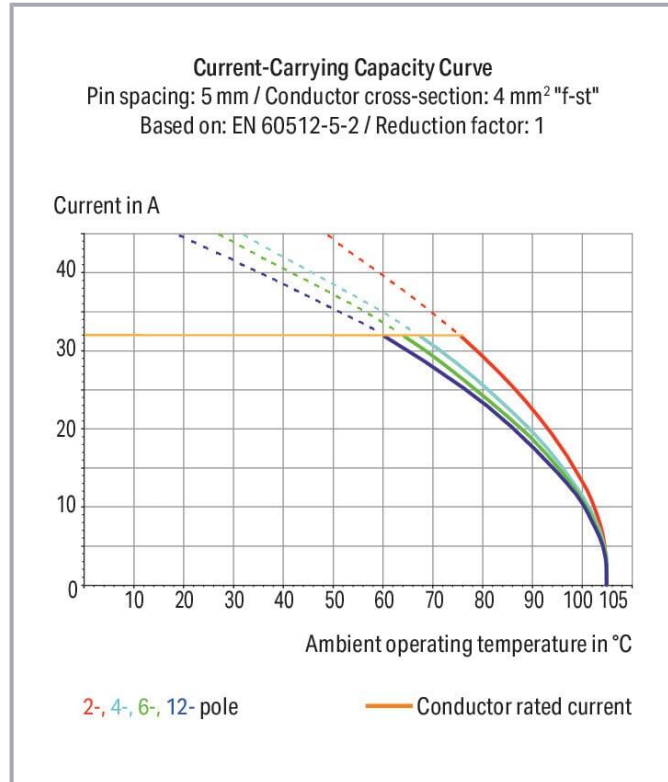

Subject to changes. Please also observe the further product documentation!

WAGO GmbH & Co. KG  
Hansastr. 27  
32423 Minden  
Phone: +49571 887-0 | Fax: +49571 887-169  
Email: [info.de@wago.com](mailto:info.de@wago.com) | Web: [www.wago.com](http://www.wago.com)

Do you have any questions about our products?  
We are always happy to take your call at +49 (571) 887-44222.

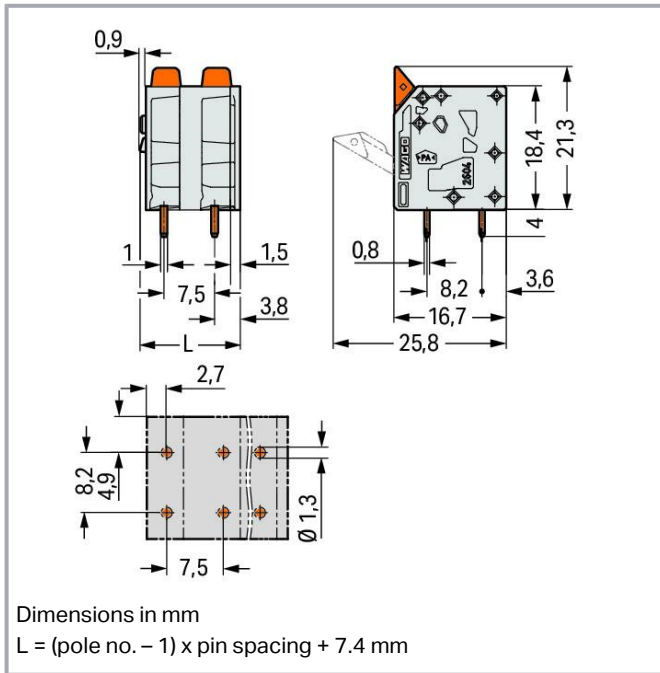

## Item description

- PCB terminal blocks with Push-in CAGE CLAMP® connection and levers
- Push-in termination of solid and ferruled conductors
- Intuitive and tool-free operation
- Several clamping units can be held open simultaneously, simplifying the connection of multi-core cables
- Testing can be performed both parallel and perpendicular to conductor entry

## Data

### Notes

Variants:

Other pole numbers

Direct marking

Other colors

Other versions (or variants) can be requested from WAGO Sales or configured at <https://configurator.wago.com/>.

## Electrical data

### Ratings per IEC/EN

Ratings per

IEC/EN 60664-1

Subject to changes. Please also observe the further product documentation!

WAGO GmbH & Co. KG

Hansastr. 27

32423 Minden

Phone: +49571 887-0 | Fax: +49571 887-169

Email: [info.de@wago.com](mailto:info.de@wago.com) | Web: [www.wago.com](http://www.wago.com)

Do you have any questions about our products?

We are always happy to take your call at +49 (571) 887-44222.



Nominal voltage (III/3)	630 V
Rated impulse voltage (III/3)	6 kV
Rated voltage (III/2)	1000 V
Rated impulse voltage (III/2)	6 kV
Nominal voltage (II/2)	1000 V
Rated surge voltage (II/2)	6 kV
Rated current	32 A
Legend (ratings)	(III / 2) ≙ Overvoltage category III / Pollution degree 2

### Ratings per UL

Approvals per	UL 1059
Rated voltage UL (Use Group B)	300 V
Rated current UL (Use Group B)	20 A
Rated voltage UL (Use Group C)	300 V
Rated current UL (Use Group C)	20 A
Rated voltage UL (Use Group D)	600 V
Rated current UL (Use Group D)	5 A

### Ratings per CSA

Approvals per	CSA
Rated voltage CSA (Use Group B)	300 V
Rated current CSA (Use Group B)	20 A
Rated voltage CSA (Use Group C)	300 V
Rated current CSA (Use Group C)	20 A
Rated voltage CSA (Use Group D)	600 V
Rated current CSA (Use Group D)	5 A

### Connection data

Connection points	6
Total number of potentials	6
Number of connection types	1
Number of levels	1

### Connection 1

Connection technology	Push-in CAGE CLAMP®
Actuation type	Lever

Subject to changes. Please also observe the further product documentation!



Solid conductor	0.2 ... 4 mm <sup>2</sup> / 24 ... 12 AWG
Fine-stranded conductor	0.2 ... 4 mm <sup>2</sup> / 24 ... 12 AWG
Fine-stranded conductor; with insulated ferrule	0.25 ... 2.5 mm <sup>2</sup>
Fine-stranded conductor; with uninsulated ferrule	0.25 ... 2.5 mm <sup>2</sup>
Fine-stranded conductor; with twin ferrule	0.25 ... 1.5 mm <sup>2</sup>
Strip length	9 ... 11 mm / 0.35 ... 0.43 inches
Conductor connection direction to PCB	90 °
Pole number	6

### Physical data

Pin spacing	7.5 mm / 0.295 inches
Width	44.9 mm / 1.768 inches
Height	25.3 mm / 0.996 inches
Height from the surface	21.3 mm / 0.839 inches
Depth	16.7 mm / 0.657 inches
Solder pin length	4 mm
Solder pin dimensions	0.8 x 1 mm
Drilled hole diameter with tolerance	1.3 <sup>(+0.1)</sup> mm

### PCB contact

PCB contact	THT
Solder pin arrangement	over the entire terminal strip (in-line)
Number of solder pins per potential	2

### Material data

Note (material data)	Information on material specifications can be found here
Color	gray
Material group	I
Insulation material	Polyamide (PA66)
Flammability class per UL94	V0
Clamping spring material	Chrome-nickel spring steel (CrNi)
Contact material	Electrolytic copper (E <sub>Cu</sub> )
Contact plating	Tin
Fire load	0.114 MJ
Actuator color	orange

Subject to changes. Please also observe the further product documentation!

Weight	11.9 g
--------	--------

### Environmental requirements

Limit temperature range	-60 ... +105 °C
Processing temperature	-35 ... +60 °C
Continuous operating temperature	-60 ... +105 °C

### Commercial data



eCl@ss 10.0	27-44-04-01
eCl@ss 9.0	27-44-04-01
ETIM 8.0	EC002643
ETIM 7.0	EC002643
ECCN	NO DATA
PU (SPU)	45 pcs
Packaging type	box
Country of origin	PL
GTIN	4055143564885
Customs tariff number	85369010000

### Environmental Product Compliance

RoHS Compliance Status	Compliant, No Exemption
------------------------	-------------------------

### Approvals / Certificates

#### General approvals







Logo	Approval	Additional Approval Text	Certificate name
	<b>CB</b> DEKRA Certification B.V.	IEC 60947-7-4	NL-61583
	<b>CSA</b> DEKRA Certification B.V.	C22.2 No. 158	70117145
	<b>cURus</b> Underwriters Laboratories Inc.	UL 1059	E45172
	<b>KEMA/KEUR</b> DEKRA Certification B.V.	EN 60947-7-4	71- 100535

Subject to changes. Please also observe the further product documentation!



## Optional accessories

### Ferrule

Ferrule		
	<b>Item no.: 216-106</b> Ferrule; Sleeve for 2.5 mm <sup>2</sup> / AWG 14; uninsulated; electro-tin plated; silver-colored	<a href="http://www.wago.com/216-106">www.wago.com/216-106</a>
	<b>Item no.: 216-241</b> Ferrule; Sleeve for 0.5 mm <sup>2</sup> / 20 AWG; insulated; electro-tin plated; electrolytic copper; gastight crimped; acc. to DIN 46228, Part 4/09.90; white	<a href="http://www.wago.com/216-241">www.wago.com/216-241</a>
	<b>Item no.: 216-242</b> Ferrule; Sleeve for 0.75 mm <sup>2</sup> / 18 AWG; insulated; electro-tin plated; electrolytic copper; gastight crimped; acc. to DIN 46228, Part 4/09.90; gray	<a href="http://www.wago.com/216-242">www.wago.com/216-242</a>
	<b>Item no.: 216-243</b> Ferrule; Sleeve for 1 mm <sup>2</sup> / AWG 18; insulated; electro-tin plated; electrolytic copper; gastight crimped; acc. to DIN 46228, Part 4/09.90; red	<a href="http://www.wago.com/216-243">www.wago.com/216-243</a>
	<b>Item no.: 216-244</b> Ferrule; Sleeve for 1.5 mm <sup>2</sup> / AWG 16; insulated; electro-tin plated; electrolytic copper; gastight crimped; acc. to DIN 46228, Part 4/09.90; black	<a href="http://www.wago.com/216-244">www.wago.com/216-244</a>
	<b>Item no.: 216-246</b> Ferrule; Sleeve for 2.5 mm <sup>2</sup> / AWG 14; insulated; electro-tin plated; electrolytic copper; gastight crimped; acc. to DIN 46228, Part 4/09.90; blue	<a href="http://www.wago.com/216-246">www.wago.com/216-246</a>

## Downloads

### Documentation

#### Additional Information

Technical Section	2019 Apr 3	pdf	Download
Technical explanations		2.1 MB	

## CAD/CAE-Data

### CAD data

2D/3D Models 2604-3306	URL	Download
------------------------	-----	----------

### PCB Design

Symbol and Footprint via Ultra Librarian 2604-3306	URL	Download
--	-----	----------

Subject to changes. Please also observe the further product documentation!



CAX data for your PCB design, consisting of "schematic symbols and PCB footprints", allow easy integration of the WAGO component into your development environment.

Supported formats:

- Accel EDA 14 & 15
- Altair
- Altium 6 to current version
- Autodesk Fusion 360
- Cadence Allegro
- DesignSpark
- Eagle Libraries
- KiCad
- Mentor Graphics
- BoardStation
- Mentor Graphics Design Architect
- Mentor Graphics Design
- Expedition 99 and 2000
- OrCAD 9.X PCB and Capture
- PADS PowerPCB 3, 3.5, 4.X, and 5.X
- PADS PowerPCB and PowerLogic 3.0
- PCAD 2000, 2001, 2002, 2004, and 2006
- Pulsonix 8.5 or newer
- STL
- 3D STEP
- TARGET 3001!
- View Logic ViewDraw
- Quadcept
- Zuken CadStar 3 and 4
- Zuken CR-5000 and CR-8000
- Zuken eCADSTAR 2020 and 2021Zuken CR-5000 and CR-8000

#### PCB Component Libraries (EDA), PCB CAD Library Ultra Librarian

---

Symbol and Footprint via SamacSys 2604-3306

[URL](#)

[Download](#)

CAX data for your PCB design, consisting of "schematic symbols and PCB footprints", allow easy integration of the WAGO component into your development environment.

Supported formats:

—

Subject to changes. Please also observe the further product documentation!

---

WAGO GmbH & Co. KG

Hansastr. 27

32423 Minden

Phone: +49571 887-0 | Fax: +49571 887-169

Email: [info.de@wago.com](mailto:info.de@wago.com) | Web: [www.wago.com](http://www.wago.com)

Do you have any questions about our products?

We are always happy to take your call at +49 (571) 887-44222.



- 3D (stp)
- Altium
- CADSTAR
- Capture
- CircuitStudio
- CR-5000
- CR-8000
- DEHDL
- DesignSpark PCB
- DesignSpark PCB PRO
- DipTrace
- EAGLE
- Easy-PC
- EasyEDA
- eCADSTAR
- KiCad
- OrCAD\_Allegro16
- PADS
- Proteus
- Pulsonix
- Quadcept
- SOLIDWORKS PCB
- TARGET 3001!
- xDX Designer
- Xpedition

PCB Component Libraries (EDA), PCB CAD Library SamacSys Electronic Component Search Engine

---

**CAE data**

ZUKEN Portal 2604-3306	<a href="#">URL</a>	<a href="#">Download</a>
------------------------	---------------------	--------------------------

---

**Asset Administration Shell**

Asset Administration Shell 2604-3306	<a href="#">URL</a>	<a href="#">Download</a>
--------------------------------------	---------------------	--------------------------

---

Subject to changes. Please also observe the further product documentation!

---

WAGO GmbH & Co. KG  
Hansastr. 27  
32423 Minden  
Phone: +49571 887-0 | Fax: +49571 887-169  
Email: [info.de@wago.com](mailto:info.de@wago.com) | Web: [www.wago.com](http://www.wago.com)

Do you have any questions about our products?  
We are always happy to take your call at +49 (571) 887-44222.



## Environmental Product Compliance

### Compliance Search

Environmental Product Compliance 2604-3306

[URL](#)

[Download](#)

PCB terminal block; lever; 4 mm<sup>2</sup>; Pin spacing 7.5 mm; 6-pole; Push-in CAGE CLAMP®; 4,00 mm<sup>2</sup>; gray

---

## Installation Notes

### Conductor termination

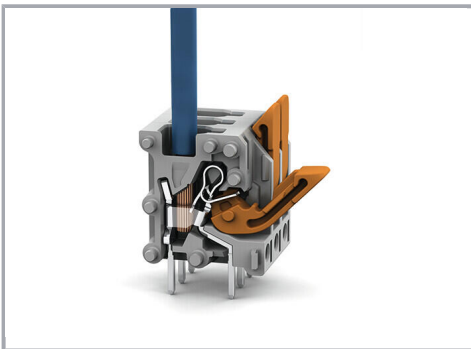

Insert fine-stranded conductors – and remove all conductors – via operating tool.

### Conductor termination

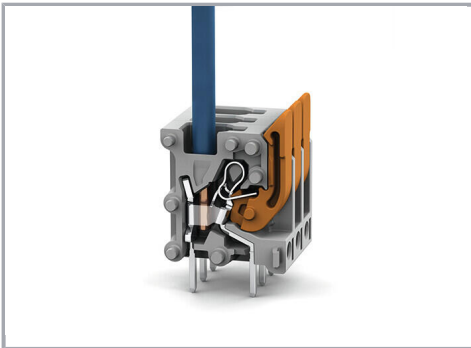

Insert solid conductors via push-in termination.

Subject to changes. Please also observe the further product documentation!