

High Frequency Ceramic Solutions

5.4GHz EIA 0603 Mini Balun with DC Feed Option. 100Ω Differential Impedance, 50Ω Single Ended

P/N 5400BL14B100

Detail Specification: 7/12/2019

Page 1 of 4

General Specifications

Part Number	5400BL14B100	Phase Difference (degree)	180 ± 15 @ 4900 - 5875
Frequency (MHz)	4900 - 5950		180 ± 20 @ 5875 - 5950
Balanced Diff. Impedance	100 Ω	Return Loss	9.5 dB min.
Unbalanced Impedance	50 Ω	Operating Temperature	-40 to +85°C
Insertion Loss @ BW	0.8dB Typ (1.0 dB max.)	Reel Quantity	4,000 pcs
Amplitude Difference	1.5 dB max.	Power Capacity	0.5W max. (CW)

You can download measured s-parameters of this component at: <https://www.johansontechnology.com/baluns>

Part Number Explanation

P/N Suffix	Packaging Style	Bulk	Suffix = S	Eg. 5400BL14B100S
		T & R	Suffix = T	Eg. 5400BL14B100T (Reel: 4000pcs.)
	Termination Style	100% Tin	Suffix = None	Eg. 5400BL14B100(T or S)

Mechanical Dimensions

	In	mm
L	0.063 ± 0.004	1.60 ± 0.10
W	0.031 ± 0.004	0.80 ± 0.10
T	0.024 ± 0.004	0.60 ± 0.10
a	0.008 ± 0.004	0.20 ± 0.10
b	0.008 +0.004/0.006	0.20 +0.1/-0.15
c	0.006 ± 0.004	0.15 ± 0.10
g	0.012 ± 0.004	0.30 ± 0.10
p	0.020 ± 0.002	0.50 ± 0.05

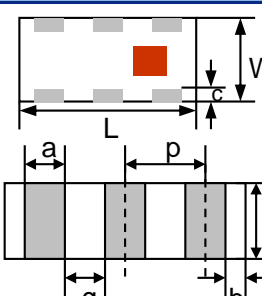

Terminal Configuration

1	Unbalanced Port	4	Balanced Port (OUT2)
2	DC feed + RD GND	5	GND
3	Balanced Port (OUT1)	6	NC

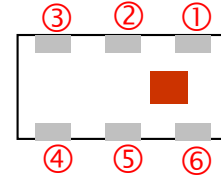

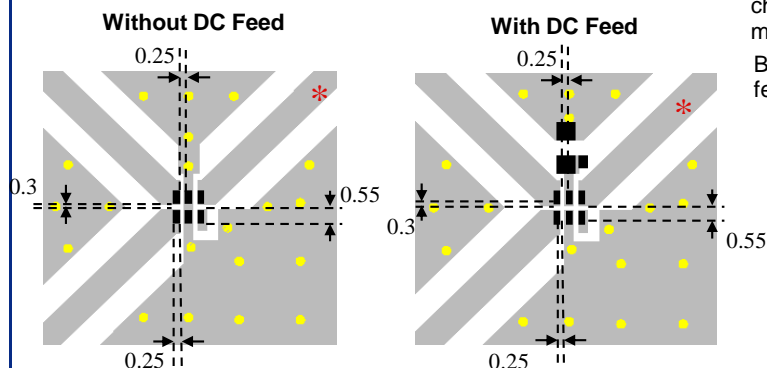

Mounting Considerations

Mount these devices with brown mark facing up.



* Line width should be designed to match 50 Ω characteristic impedance, depending on PCB material and thickness.

By-pass capacitor should be connected when feeding DC power, go to page 2 for details

-  Solder Resist
-  Land
-  Through-hole (Φ0.3)

Units: mm

Need our help laying this out for you? Need the layout file? Send us a message at: www.johansontechnology.com/component/techquestion

Johanson Technology, Inc. reserves the right to make design changes without notice.

All sales are subject to Johanson Technology, Inc. terms and conditions.



<https://www.johansontechnology.com>

4001 Calle Tecate • Camarillo, CA 93012, USA • TEL +1.805.389.1166

Ver 1.2

2019 Johanson Technology, Inc. All Rights Reserved

High Frequency Ceramic Solutions

5.4GHz EIA 0603 Mini Balun with DC Feed Option. 100Ω Differential Impedance, 50Ω Single Ended

P/N 5400BL14B100

Detail Specification: 7/12/2019

Page 2 of 4

Equivalent Circuit

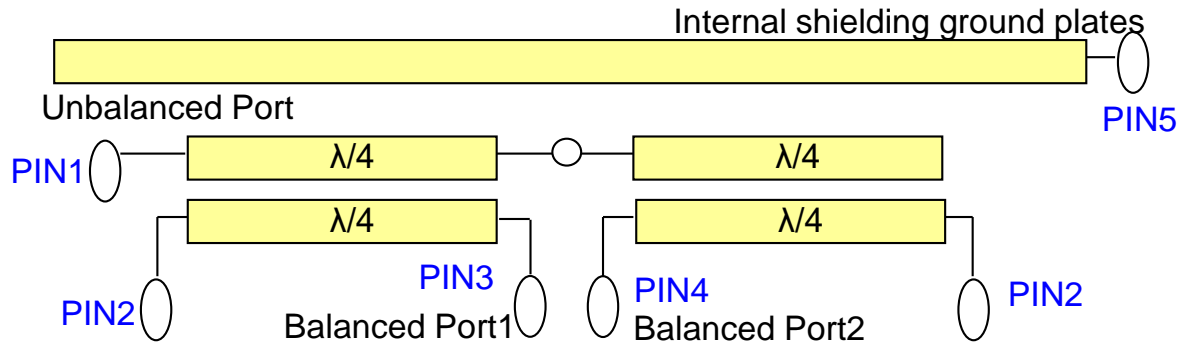

Pin 6 is a floating pin (no internal connections) but it still must have soldering pad

Measuring Diagram

DC-Feed recommended L/C network:

Capacitor value of 2.7pF and RF choke (inductor) 3.9nH are recommended when DC bias is used.

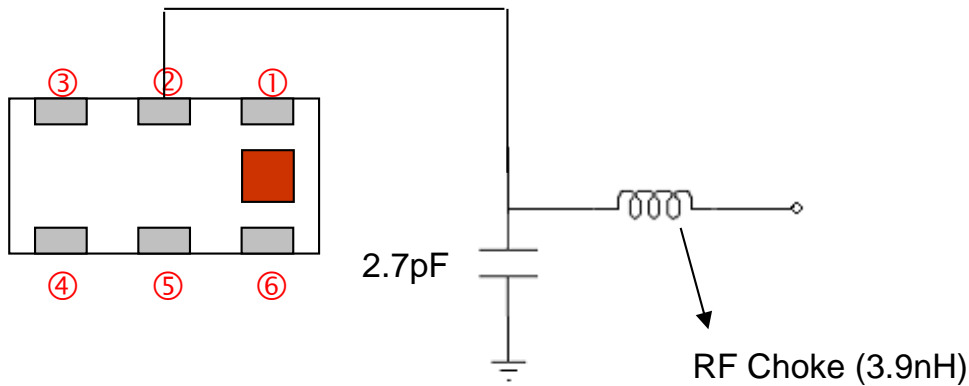

Bypass capacitor and RF choke should be placed physically as close as possible to PIN2 of balun.

Johanson Technology, Inc. reserves the right to make design changes without notice.

All sales are subject to Johanson Technology, Inc. terms and conditions.



High Frequency Ceramic Solutions

5.4GHz EIA 0603 Mini Balun with DC Feed Option. 100Ω Differential Impedance, 50Ω Single Ended

P/N 5400BL14B100

Detail Specification: 7/12/2019

Page 3 of 4

Typical Electrical Characteristics (T=25°C)

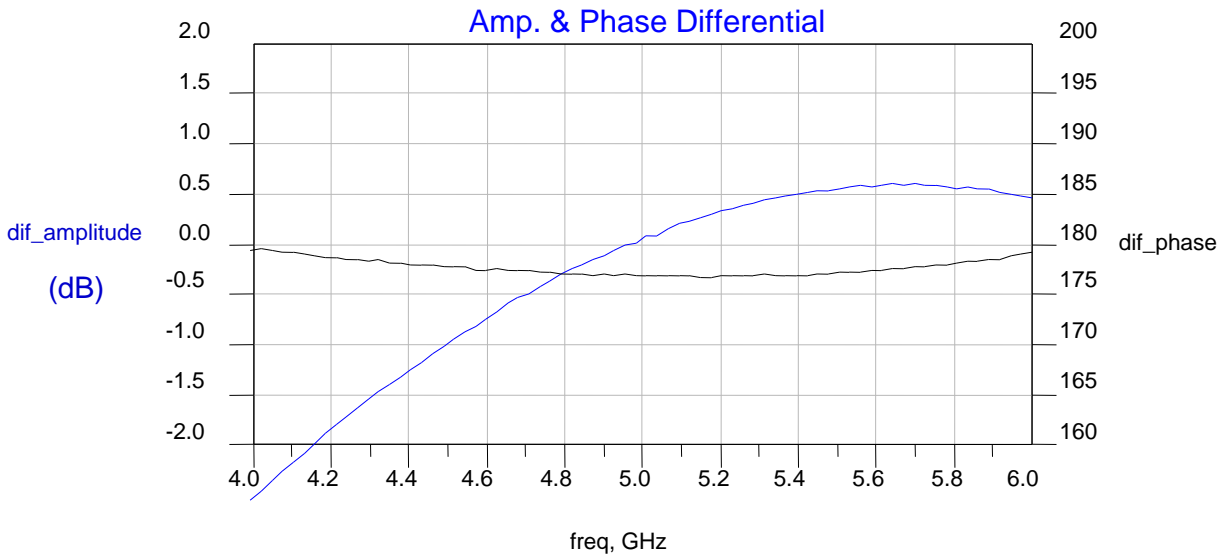
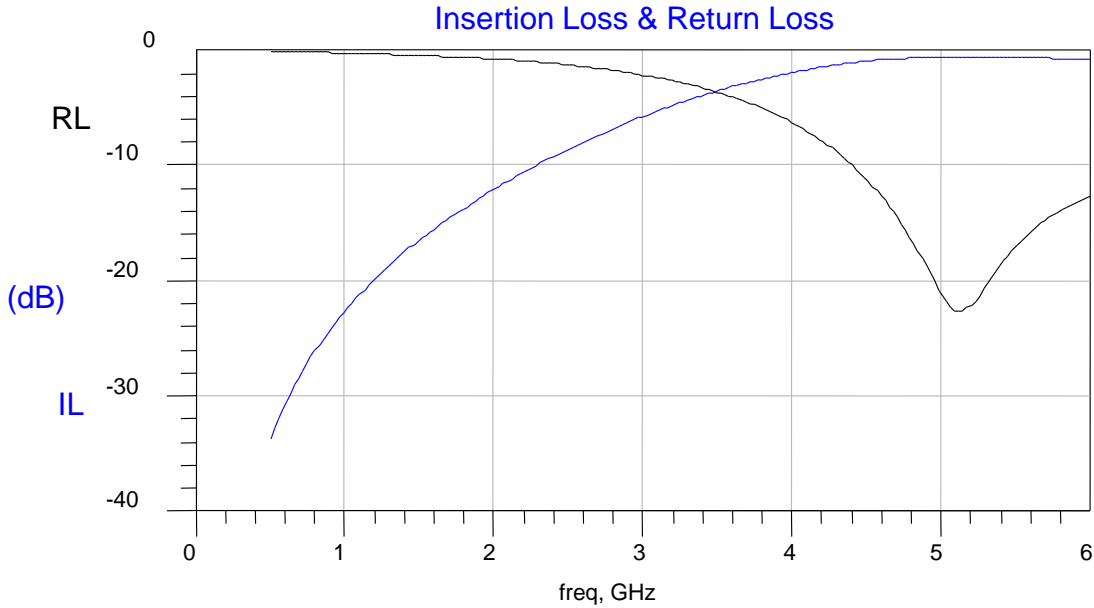

Johanson Technology, Inc. reserves the right to make design changes without notice.

All sales are subject to Johanson Technology, Inc. terms and conditions.



<https://www.johansontechnology.com>

4001 Calle Tecate • Camarillo, CA 93012, USA • TEL +1.805.389.1166

Ver 1.2

2019 Johanson Technology, Inc. All Rights Reserved

High Frequency Ceramic Solutions

5.4GHz EIA 0603 Mini Balun with DC Feed Option. 100Ω Differential Impedance, 50Ω Single Ended

P/N 5400BL14B100

Detail Specification: 7/12/2019

Page 4 of 4

More Balun info at:

<https://www.johansontechnology.com/baluns>

Packaging information

<https://www.johansontechnology.com/tape-reel-packaging>

Soldering Information

<https://www.johansontechnology.com/ipcsoldering-profile>

MSL Info

<https://www.johansontechnology.com/msl-rating>

Recommended Storage Condition and Max Shelf Life

<https://www.johansontechnology.com/recommended-storage-conditions>

RoHS Compliance

<https://www.johansontechnology.com/rohs-compliance>

Antenna layout and tuning techniques

<https://www.johansontechnology.com/tuning>

Antenna layout review, tuning, and characterization services

<https://www.johansontechnology.com/ipc-antenna-services>

Layout Files, s-parameters and any other technical questions

<https://www.johansontechnology.com/ask-a-question>

Johanson Technology, Inc. reserves the right to make design changes without notice.

All sales are subject to Johanson Technology, Inc. terms and conditions.



<https://www.johansontechnology.com>

4001 Calle Tecate • Camarillo, CA 93012, USA • TEL +1.805.389.1166

Ver 1.2

2019 Johanson Technology, Inc. All Rights Reserved