

PAGE 1/2

ISSUE 22-03-22

SERIE : DPDT

PART NUMBER : R577313002

RF CHARACTERISTICS

Frequency range : **0 - 3 GHz**
 Impedance : **50 Ohms**

Frequency (GHz)	DC - 3
VSWR max	1.20
Insertion loss max	0.20 dB
Isolation min	80 dB
Average power (*)	240 W

ELECTRICAL CHARACTERISTICS

Actuator : **FAILSAFE**
 Nominal current ** : **140 mA**
 Actuator voltage (Vcc) : **28V (24 to 30V)**
 Terminals : **solder pins (250°C max. / 30 sec.)**

MECHANICAL CHARACTERISTICS

Connectors : **SMA female per MIL-C 39012**
 Life : **2.5 million cycles**
 Switching Time*** : **< 15 ms**
 Construction : **Splashproof**
 Weight : **< 100 g**

ENVIRONMENTAL CHARACTERISTICS

Operating temperature range : **-40°C to +85°C**
 Storage temperature range : **-55°C to +85°C**

(* Average power at 25°C per RF Path)

(** At 25° C ±10%)

(*** Nominal voltage ; 25° C)



PAGE 2/2

ISSUE 22-03-22

SERIE : DPDT

PART NUMBER : R577313002

DRAWING

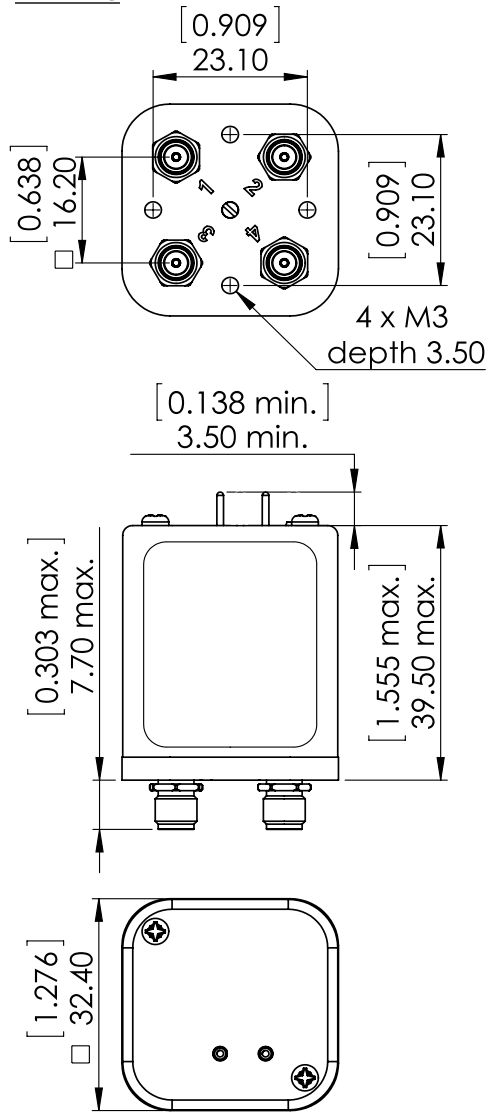

General tolerances : ±0,5 mm [0,02 in]

LABEL

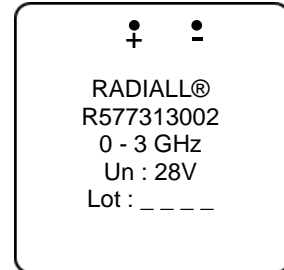

SCHEMATIC DIAGRAM

Position : De energized

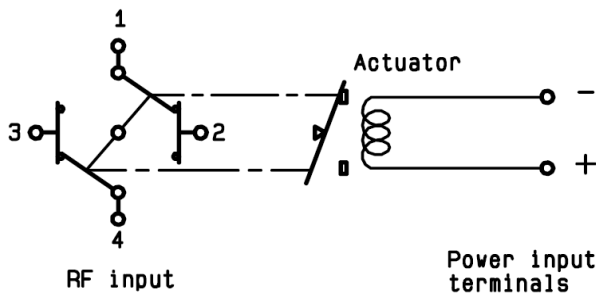

Voltage	RF Continuity
energized	1 ↔ 3 / 2 ↔ 4
De-energized	1 ↔ 2 / 3 ↔ 4