

August 1991

Features

- 1.7A and 2.0A, 350V - 400V
- $r_{DS(on)} = 3.6\Omega$ and 5.0Ω
- Single Pulse Avalanche Energy Rated*
- SOA is Power-Dissipation Limited
- Nanosecond Switching Speeds
- Linear Transfer Characteristics
- High Input Impedance

Description

The IRF710, IRF711, IRF712, and IRF713 are n-channel enhancement-mode silicon-gate power field-effect transistors. IRF710R, IRF711R, IRF712R and IRF713R types are advanced power MOSFETs designed, tested, and guaranteed to withstand a specified level of energy in the breakdown avalanche mode of operation. All of these power MOSFETs are designed for applications such as switching regulators, switching converters, motor drivers, relay drivers, and drivers for high-power bipolar switching transistors requiring high speed and low gate-drive power. These types can be operated directly from integrated circuits.

The IRF types are supplied in the JEDEC TO-220AB plastic package.

Package

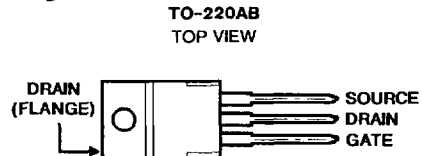

Terminal Diagram

N-CHANNEL ENHANCEMENT MODE

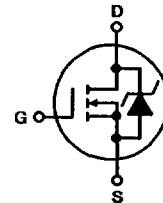

Absolute Maximum Ratings ($T_C = +25^\circ\text{C}$), Unless Otherwise Specified

| | IRF710 IRF710R | IRF711 IRF711R | IRF712 IRF712R | IRF713 IRF713R | UNITS |
|---|----------------------------|-------------------|-------------------|-------------------|---------------------|
| Drain-Source Voltage (1) | V_{DS} 400 | 350 | 400 | 350 | V |
| Drain-Gate Voltage ($R_{GS} = 20k\Omega$) (1) | V_{DGR} 400 | 350 | 400 | 350 | V |
| Continuous Drain Current | | | | | |
| $T_C = +25^\circ\text{C}$ | I_D 2 | 2 | 1.7 | 1.7 | A |
| $T_C = +100^\circ\text{C}$ | I_D 1.2 | 1.2 | 1.1 | 1.1 | A |
| Pulsed Drain Current (3) | I_{DM} 5 | 5 | 4.3 | 4.3 | A |
| Gate-Source Voltage | V_{GS} ± 20 | ± 20 | ± 20 | ± 20 | V |
| Maximum Power Dissipation | | | | | |
| $T_C = +25^\circ\text{C}$ | P_D 36 | 36 | 36 | 36 | W |
| Linear Derating Factor | 0.29 | 0.29 | 0.29 | 0.29 | W/ $^\circ\text{C}$ |
| Inductive Current, Clamped | I_{LM} 6.0 | 6.0 | 5.0 | 5.0 | A |
| (See Figure 14, $L = 100\mu\text{H}$) | | | | | |
| Single Pulse Avalanche Energy Rating (4) | E_{AS}^* 120 | 120 | 120 | 120 | mJ |
| Operating and Storage Junction | T_J, T_{STG} -55 to +150 | -55 to +150 | -55 to +150 | -55 to +150 | $^\circ\text{C}$ |
| Temperature Range | | | | | |
| Maximum Lead Temperature for Soldering | T_L 300 | 300 | 300 | 300 | $^\circ\text{C}$ |
| (0.063" (1.6mm) from case for 10s) | | | | | |

NOTES:

- $T_J = +25^\circ\text{C}$ to $+150^\circ\text{C}$.
- Pulse Test: Pulse width $\leq 300\mu\text{s}$, Duty Cycle $\leq 2\%$.
- Repetitive rating: Pulse width limited by maximum junction temperature. See Transient Thermal Impedance Curve (Figure 5).

4. $V_{DD} = 50\text{V}$, starting $T_J = +25^\circ\text{C}$, $L = 53\text{mH}$, $R_{GS} = 25\Omega$, $I_{PEAK} = 2\text{A}$. See Figure 15.

*R Suffix Types Only

IRF710, IRF711, IRF712, IRF713 IRF710R, IRF711R, IRF712R, IRF713R

Electrical Characteristics $T_C = 25^\circ\text{C}$, Unless Otherwise Specified

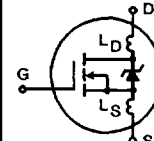
| CHARACTERISTIC | SYMBOL | TEST CONDITIONS | LIMITS | | | UNITS | |
|--|-----------------|--|--|-----|------|--------------------|----|
| | | | MIN | TYP | MAX | | |
| Drain-Source Breakdown Voltage IRF710/712, IRF710R/712R IRF711/713, IRF711R/713R | BV_{DSS} | $V_{GS} = 0V, I_D = 250\mu A$ | 400 | - | - | V | |
| | | | 350 | - | - | V | |
| Gate Threshold Voltage | $V_{GS(TH)}$ | $V_{DS} = V_{GS}, I_D = 250\mu A$ | 2.0 | - | 4.0 | V | |
| Gate-Source Leakage Forward | I_{GSS} | $V_{GS} = 20V$ | - | - | 500 | nA | |
| Gate-Source Leakage Reverse | I_{GSS} | $V_{GS} = -20V$ | - | - | -500 | nA | |
| Zero Gate Voltage Drain Current | I_{DSS} | $V_{DS} = \text{Max Rating}, V_{GS} = 0V$ $V_{DS} = \text{Max Rating} \times 0.8, V_{GS} = 0V,$ $T_J = +125^\circ\text{C}$ | - | - | 250 | μA | |
| | | | - | - | 1000 | μA | |
| On-State Drain Current (Note 2) IRF710/711, IRF710R/711R IRF712/713, IRF712R/713R | $I_{D(ON)}$ | $V_{DS} > I_{D(ON)} \times R_{DS(ON)} \text{ Max}, V_{GS} = 10V$ | 2.0 | - | - | A | |
| | | | 1.7 | - | - | A | |
| Static Drain-Source On-State Resistance (Note 2) IRF710/711, IRF710R/711R IRF712/713, IRF712R/713R | $r_{DS(ON)}$ | $V_{GS} = 10V, I_D = 1.1A$ | - | 3.3 | 3.6 | Ω | |
| | | | - | 3.6 | 5.0 | Ω | |
| Forward Transconductance (Note 2) | g_{fs} | $V_{DS} \geq 50V, I_D = 1.1A$ | 1.0 | 1.5 | - | S(\bar{J}) | |
| Input Capacitance | C_{ISS} | $V_{GS} = 0V, V_{DS} = 25V, f = 1.0\text{MHz}$ See Figure 10 | - | 135 | - | pF | |
| Output Capacitance | C_{OSS} | See Figure 10 | - | 35 | - | pF | |
| Reverse Transfer Capacitance | C_{RSS} | | - | 8.0 | - | pF | |
| Turn-On Delay Time | $t_{d(ON)}$ | $V_{DD} = 50V, I_D \approx 5.6A, R_G = 24\Omega$ See Figure 16. (MOSFET switching times are essentially independent of operating temperature) | - | 8.0 | 12 | ns | |
| Rise Time | t_r | | - | 10 | 15 | ns | |
| Turn-Off Delay Time | $t_{d(OFF)}$ | | - | 21 | 32 | ns | |
| Fall Time | t_f | | - | 11 | 17 | ns | |
| Total Gate Charge (Gate-Source + Gate-Drain) | Q_g | $V_{GS} = 10V, I_D = 2.0A, V_{DS} = 0.8V \text{ Max Rating.}$ See Figure 17 for test circuit. (Gate charge is essentially independent of operating temperature.) | - | 7.0 | 12 | nC | |
| Gate-Source Charge | Q_{gs} | | - | 1.2 | - | nC | |
| Gate-Drain ("Miller") Charge | Q_{gd} | | - | 4.0 | - | nC | |
| Internal Drain Inductance | L_D | Measured from the contact screw on tab to center of die |  | - | 3.5 | - | nH |
| | | Measured from the drain lead, 6mm (0.25in.) from package to center of die | | - | 4.5 | - | nH |
| Internal Source Inductance | L_S | Measured from the source lead, 6mm (0.25") from header and source bonding pad. | - | 7.5 | - | nH | |
| Junction-to-Case | $R_{\theta JC}$ | | - | - | 3.5 | $^\circ\text{C/W}$ | |
| Case-to-Sink | $R_{\theta CS}$ | Mounting surface flat, smooth and greased | - | 0.5 | - | $^\circ\text{C/W}$ | |
| Junction-to-Ambient | $R_{\theta JA}$ | Free air operation | - | - | 80 | $^\circ\text{C/W}$ | |

4
N-CHANNEL
POWER MOSFETs

Source Drain Diode Ratings and Characteristics

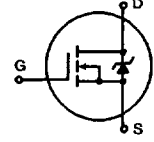
| | | | | | | | |
|---|----------|--|---|---|-----|---------|---|
| Continuous Source Current (Body Diode) | I_S | Modified MOSFET symbol showing the integral reverse P-N junction rectifier. |  | - | - | 2.0 | A |
| Pulse Source Current (Body Diode) (Note 3) | I_{SM} | | | - | - | 5.0 | A |
| Diode Forward Voltage (Note 2) | V_{SD} | $T_J = +25^\circ\text{C}, I_S = 2.0A, V_{GS} = 0V$ | - | - | 1.6 | V | |
| Reverse Recovery Time | t_{rr} | $T_J = +25^\circ\text{C}, I_F = 2.0A, di_F/dt = 100A/\mu s$ | 110 | - | 520 | ns | |
| Reverse Recovered Charge | Q_{RR} | $T_J = +25^\circ\text{C}, I_F = 2.0A, di_F/dt = 100A/\mu s$ | 0.40 | - | 1.4 | μC | |
| Forward Turn-on Time | t_{ON} | Intrinsic turn-on time is negligible. Turn-on speed is substantially controlled by $L_S + L_D$. | - | - | - | - | |

NOTES: 1. $T_J = +25^\circ\text{C}$ to $+150^\circ\text{C}$
 2. Pulse Test: Pulse width $\leq 300\mu s$, Duty Cycle $\leq 2\%$
 3. Repetitive Rating: Pulse width limited by max. junction temperature. See Transient Thermal Impedance Curve (Figure 5)
 4. $V_{DD} = 50V$, Start $T_J = +25^\circ\text{C}$, $L = 53mH$, $R_{GS} = 25\Omega$, $I_{PEAK} = 2A$ (See Figure 15)

Performance Curves

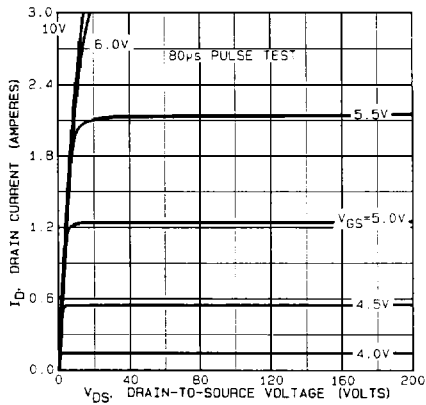

FIGURE 1. TYPICAL OUTPUT CHARACTERISTICS

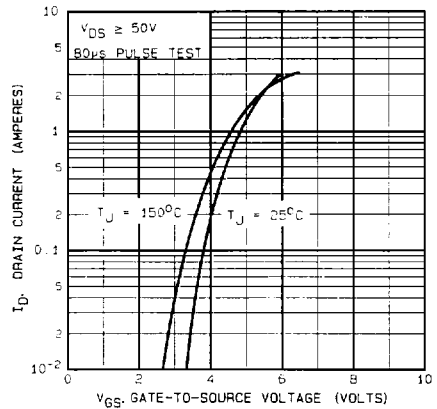

FIGURE 2. TYPICAL TRANSFER CHARACTERISTICS

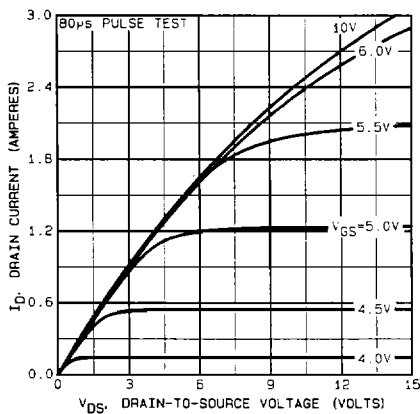

FIGURE 3. TYPICAL SATURATION CHARACTERISTICS

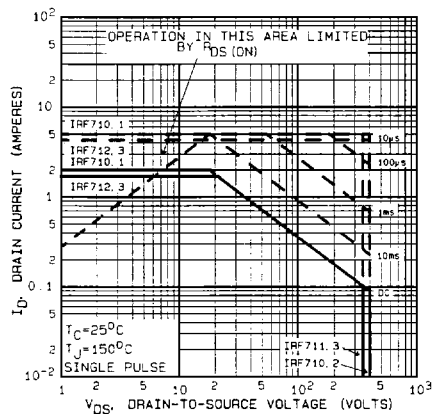

FIGURE 4. MAXIMUM SAFE OPERATING AREA

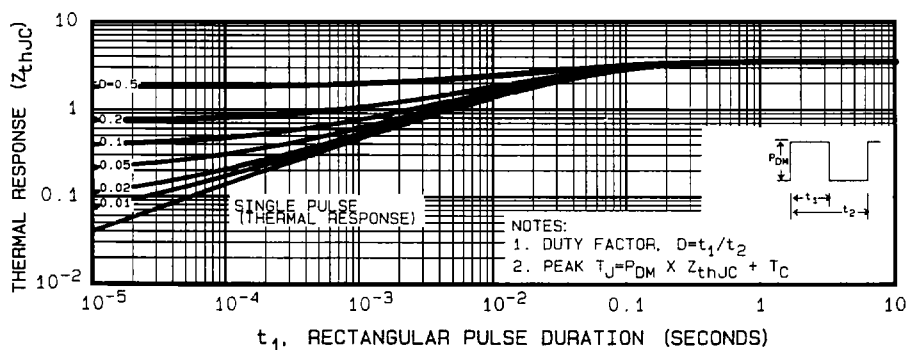

FIGURE 5. MAXIMUM EFFECTIVE TRANSIENT THERMAL IMPEDANCE, JUNCTION-TO-CASE vs PULSE DURATION

Performance Curves (Continued)

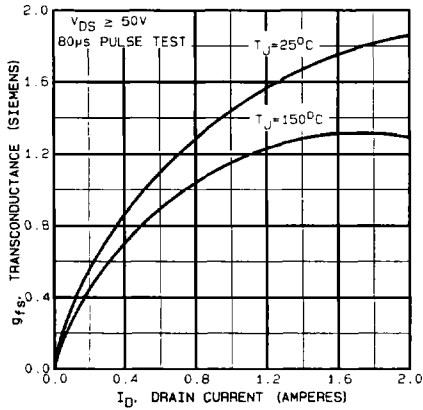

FIGURE 6. TYPICAL TRANSCONDUCTANCE vs DRAIN CURRENT

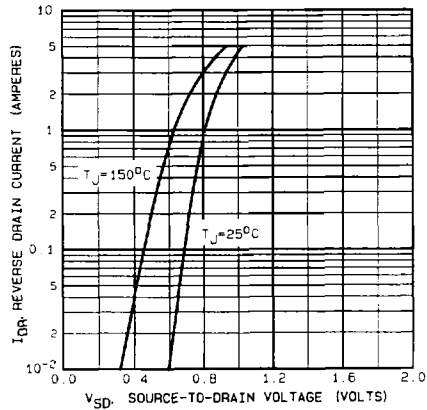

FIGURE 7. TYPICAL SOURCE-DRAIN DIODE FORWARD VOLTAGE

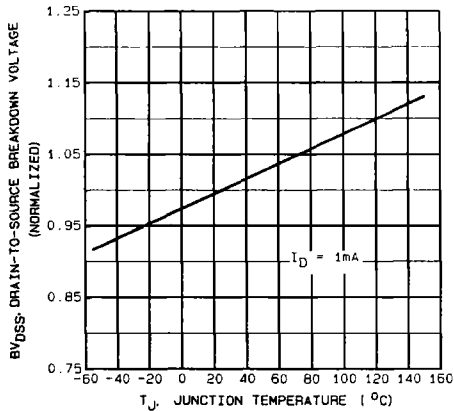

FIGURE 8. BREAKDOWN VOLTAGE vs TEMPERATURE

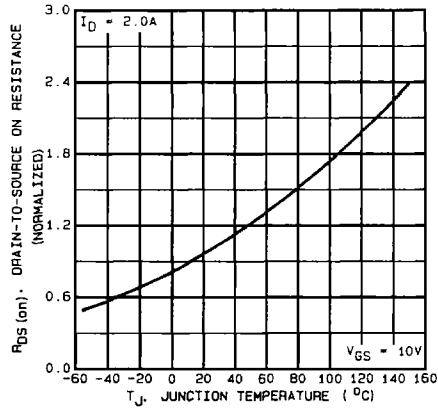

FIGURE 9. NORMALIZED ON-RESISTANCE vs TEMPERATURE

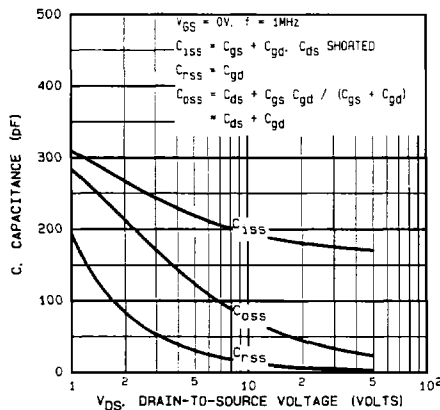

FIGURE 10. TYPICAL CAPACITANCE vs DRAIN-TO-SOURCE VOLTAGE

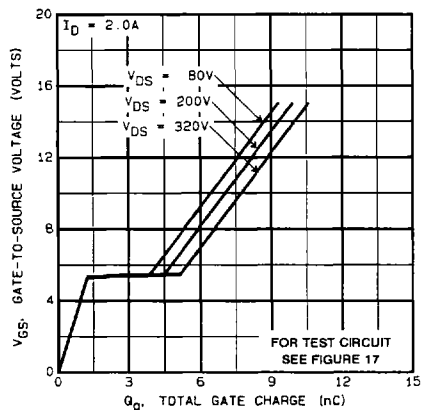

FIGURE 11. TYPICAL GATE CHARGE vs GATE-TO-SOURCE VOLTAGE

4
N-CHANNEL
POWER MOSFETS

Performance Curves (Continued)

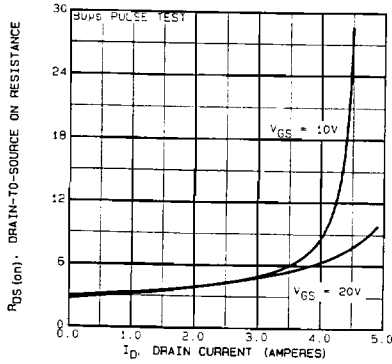

FIGURE 12. TYPICAL ON-RESISTANCE VS. DRAIN CURRENT

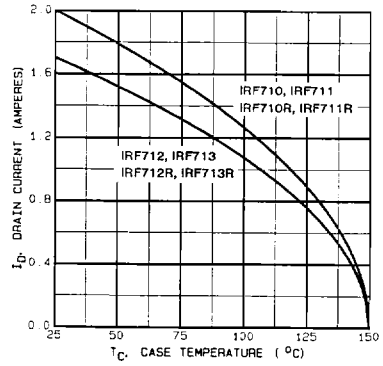

FIGURE 13. MAXIMUM DRAIN CURRENT VS. CASE TEMPERATURE

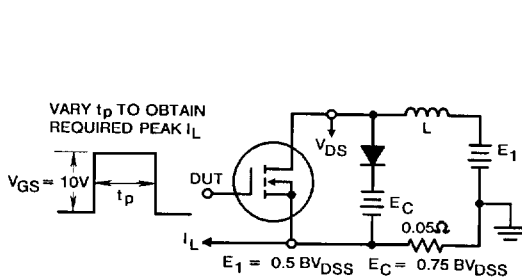

FIGURE 14a. CLAMPED INDUCTIVE TEST CIRCUIT

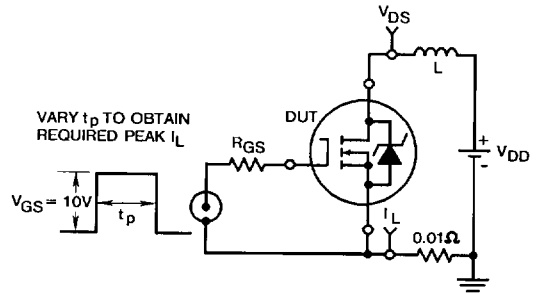

FIGURE 15a. UNCLAMPED ENERGY TEST CIRCUIT

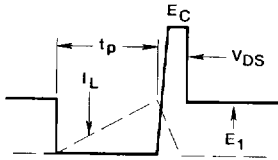

FIGURE 14b. CLAMPED INDUCTIVE WAVEFORMS

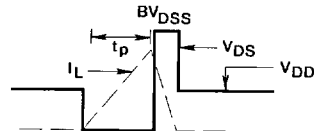

FIGURE 15b. UNCLAMPED ENERGY WAVEFORMS

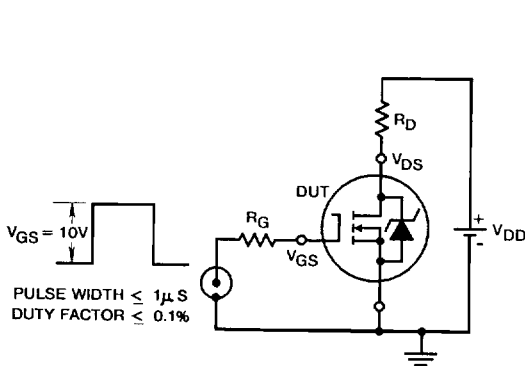

FIGURE 16. SWITCHING TIME TEST CIRCUIT

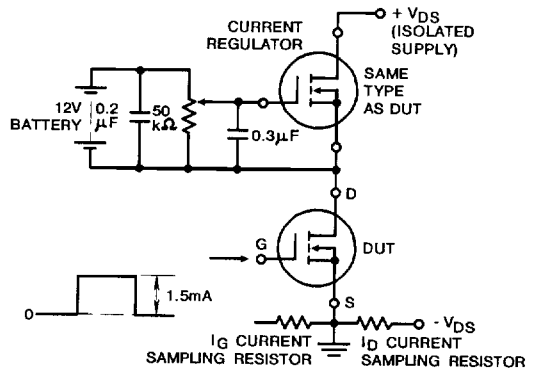

FIGURE 17. GATE CHARGE TEST CIRCUIT