

Automotive MOSFET

OptiMOS™-5 Power-Transistor



Features

- OptiMOS™ power MOSFET for automotive applications
- N-channel – Enhancement mode – Normal Level
- Extended qualification beyond AEC-Q101
- Enhanced electrical testing
- Robust design
- MSL1 up to 260°C peak reflow
- 175°C operating temperature
- Green product (RoHS compliant)
- 100% Avalanche tested

Potential applications

General automotive applications.

Product validation

Qualified for automotive applications. Product validation according to AEC-Q101.

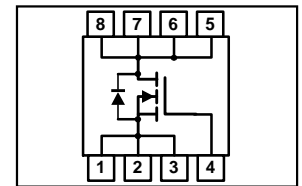
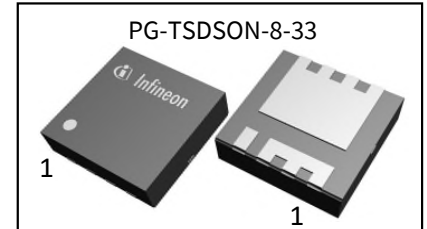

Product Summary

V_{DS}	40	V
$R_{DS(on)}$	3.9	mΩ
I_D (chip limited)	89	A

Type	Package	Marking
IPZ40N04S5-3R9	PG-TSDSON-8-33	5N0439



Table of Contents

Description 1

Maximum ratings 3

Thermal characteristics 4

Electrical characteristics 4

Electrical characteristics diagrams 6

Package outline & footprint 10

Revision history 11

Disclaimer 12

Maximum ratings

at $T_j=25\text{ °C}$, unless otherwise specified

Parameter	Symbol	Conditions	Value	Unit
Continuous drain current	I_D	$V_{GS}=10\text{ V}$, Chip limitation ^{1,2)}	89	A
		$V_{GS}=10\text{V}$, DC current ³⁾	40	
		$T_a=85\text{ °C}$, $V_{GS}=10\text{ V}$, R_{thJA} on 2s2p ^{2,4)}	14	
Pulsed drain current ²⁾	$I_{D,pulse}$	$T_C=25\text{ °C}$, $t_p=100\text{ }\mu\text{s}$	256	
Avalanche energy, single pulse ²⁾	E_{AS}	$I_D=20\text{ A}$	78	mJ
Avalanche current, single pulse	I_{AS}	–	40	A
Gate source voltage	V_{GS}	–	± 20	V
Power dissipation	P_{tot}	$T_C=25\text{ °C}$	58	W
Operating and storage temperature	T_j, T_{stg}	–	-55 ... +175	°C
IEC climatic category; DIN IEC 68-1	–	–	55/175/56	

Thermal characteristics²⁾

Parameter	Symbol	Conditions	Values			Unit
			min.	typ.	max.	
Thermal resistance, junction - case	R_{thJC}	–	–	–	2.6	K/W
Thermal resistance, junction - ambient ⁴⁾	R_{thJA}	–	–	39.5	–	

Electrical characteristics

 at $T_j=25\text{ °C}$, unless otherwise specified

Parameter	Symbol	Conditions	Values			Unit
			min.	typ.	max.	

Static characteristics

Drain-source breakdown voltage	$V_{(BR)DSS}$	$V_{GS}=0\text{ V}$, $I_D=1\text{ mA}$	40	–	–	V
Gate threshold voltage	$V_{GS(th)}$	$V_{DS}=V_{GS}$, $I_D=21\text{ }\mu\text{A}$	2.2	2.8	3.4	
Zero gate voltage drain current	I_{DSS}	$V_{DS}=40\text{ V}$, $V_{GS}=0\text{ V}$, $T_j=25\text{ °C}$	–	–	1	μA
		$V_{DS}=40\text{ V}$, $V_{GS}=0\text{ V}$, $T_j=100\text{ °C}^{2)}$	–	–	100	
Gate-source leakage current	I_{GSS}	$V_{GS}=20\text{ V}$, $V_{DS}=0\text{ V}$	–	–	100	nA
Drain-source on-state resistance	$R_{DS(on)}$	$V_{GS}=7\text{ V}$, $I_D=10\text{ A}$	–	4.0	4.8	m Ω
		$V_{GS}=10\text{ V}$, $I_D=20\text{ A}$	–	3.4	3.9	
Gate resistance ²⁾	R_G	–	–	2.23	–	Ω

Parameter	Symbol	Conditions	Values			Unit
			min.	typ.	max.	
Dynamic characteristics²⁾						
Input capacitance	C_{iss}	$V_{GS}=0\text{ V}, V_{DS}=25\text{ V}, f=1\text{ MHz}$	-	1306	1737	pF
Output capacitance	C_{oss}		-	365	485	
Reverse transfer capacitance	C_{rss}		-	21	32	
Turn-on delay time	$t_{d(on)}$	$V_{DD}=20\text{ V}, V_{GS}=10\text{ V}, I_D=20\text{ A}, R_G=3.5\ \Omega$	-	4.6	-	ns
Rise time	t_r		-	2.2	-	
Turn-off delay time	$t_{d(off)}$		-	7.9	-	
Fall time	t_f		-	4.8	-	

Gate Charge Characteristics²⁾

Gate to source charge	Q_{gs}	$V_{DD}=20\text{ V}, I_D=20\text{ A}, V_{GS}=0\text{ to }10\text{ V}$	-	5.9	7.7	nC
Gate to drain charge	Q_{gd}		-	3.9	5.9	
Gate charge total	Q_g		-	19.2	25.0	
Gate plateau voltage	$V_{plateau}$		-	4.7	-	V

Reverse Diode

Diode continuous forward current ²⁾	I_S	$T_C=25\text{ }^\circ\text{C}$	-	-	40	A
Diode pulse current ²⁾	$I_{S,pulse}$	$T_C=25\text{ }^\circ\text{C}, t_p=100\ \mu\text{s}$	-	-	256	
Diode forward voltage	V_{SD}	$V_{GS}=0\text{ V}, I_F=20\text{ A}, T_j=25\text{ }^\circ\text{C}$	-	0.8	1.1	V
Reverse recovery time ²⁾	t_{rr}	$V_R=20\text{ V}, I_F=40\text{ A}, di_f/dt=100\text{ A}/\mu\text{s}$	-	27.1	-	ns
Reverse recovery charge ²⁾	Q_{rr}		-	16.0	-	

¹⁾ Practically the current is limited by the overall system design including the customer-specific PCB.

²⁾ The parameter is not subject to production testing – specified by design.

³⁾ Current is limited by the package.

⁴⁾ Device on 2s2p FR4 PCB defined in accordance with JEDEC standards (JESD51-5, -7). PCB is vertical in still air.

Electrical characteristics diagrams

1 Power dissipation

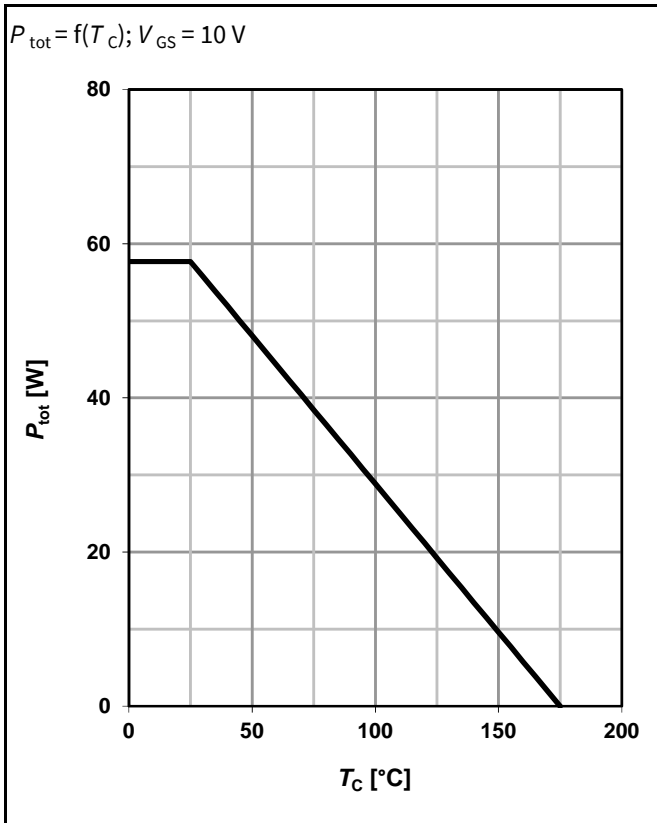

2 Drain current

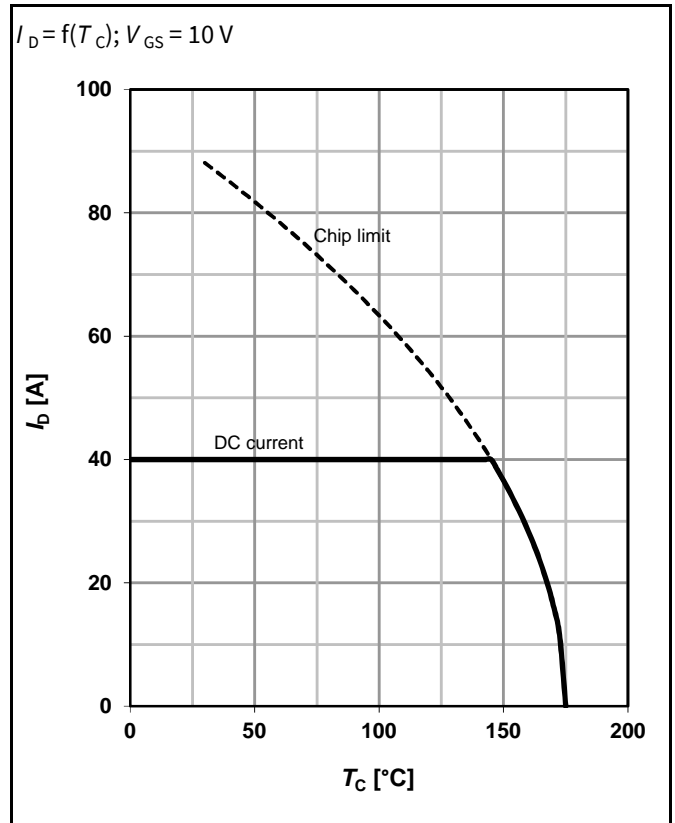

3 Safe operating area

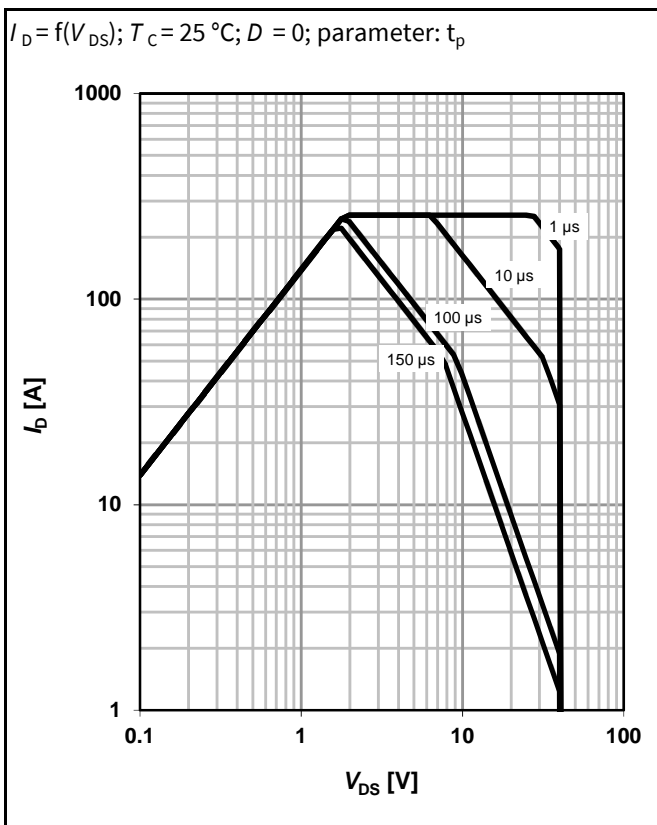

4 Max. transient thermal impedance

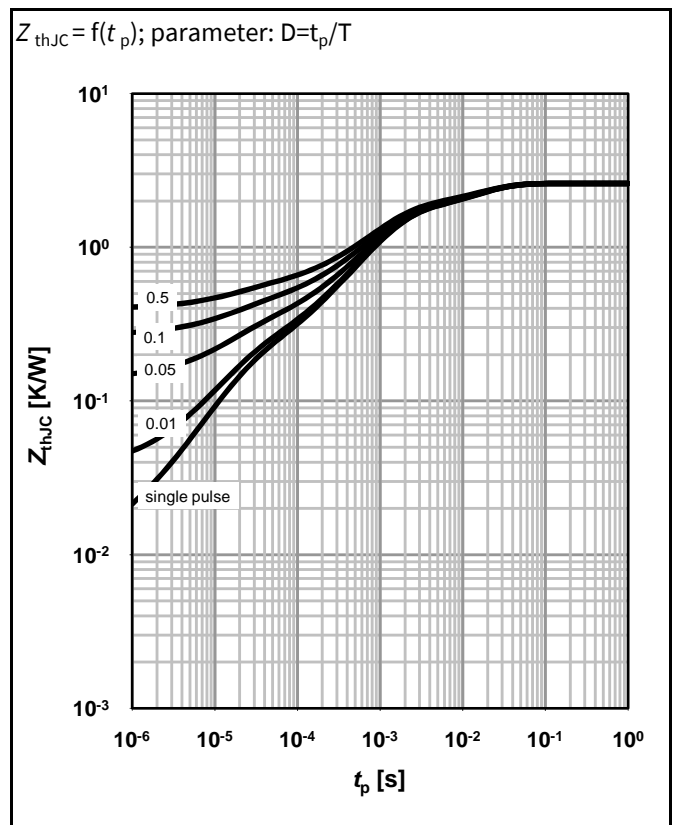

5 Typ. output characteristics

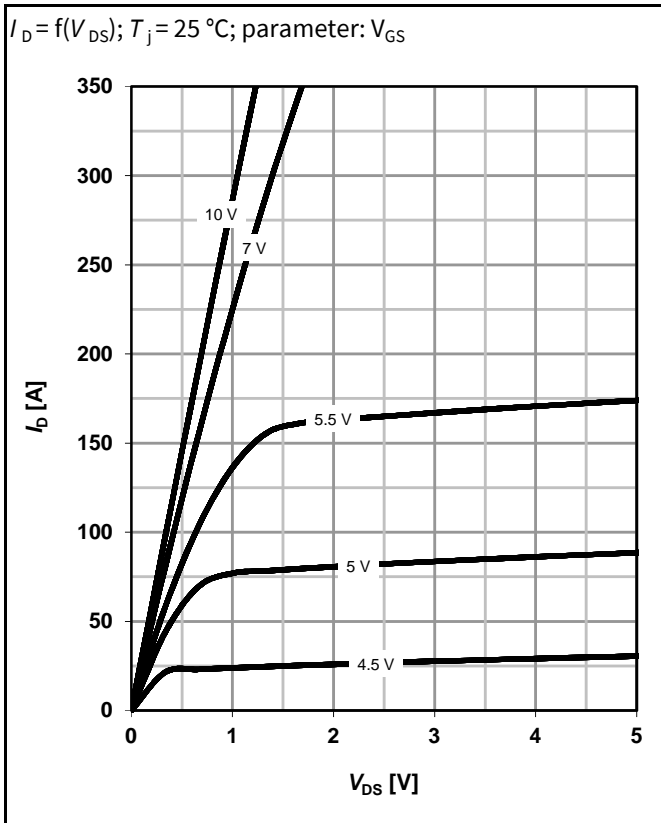

6 Typ. drain-source on-state resistance

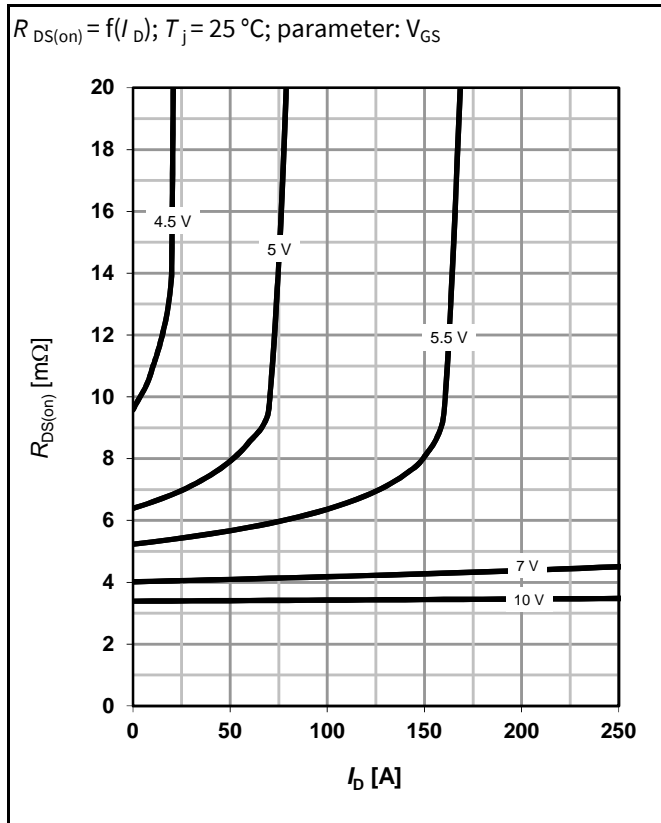

7 Typ. transfer characteristics

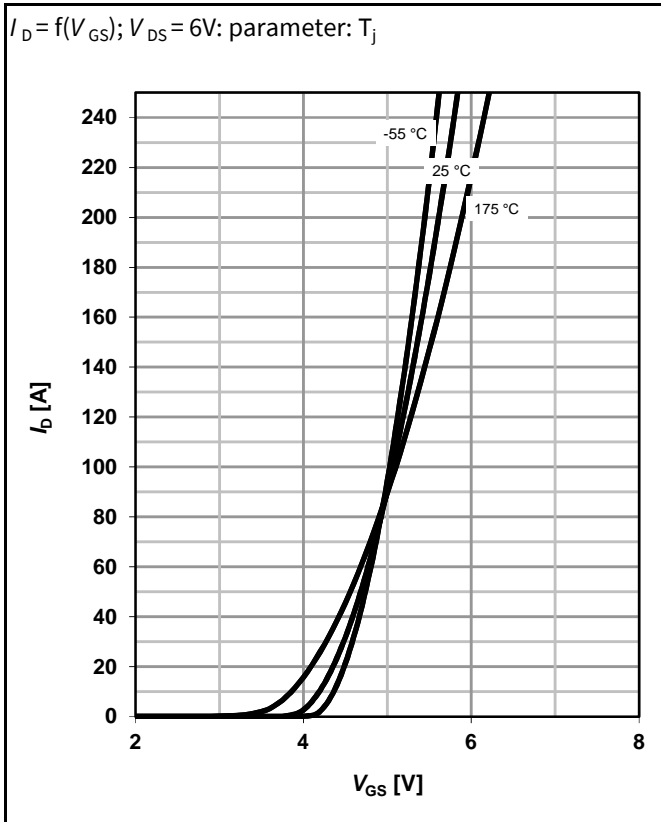

8 Typ. drain-source on-state resistance

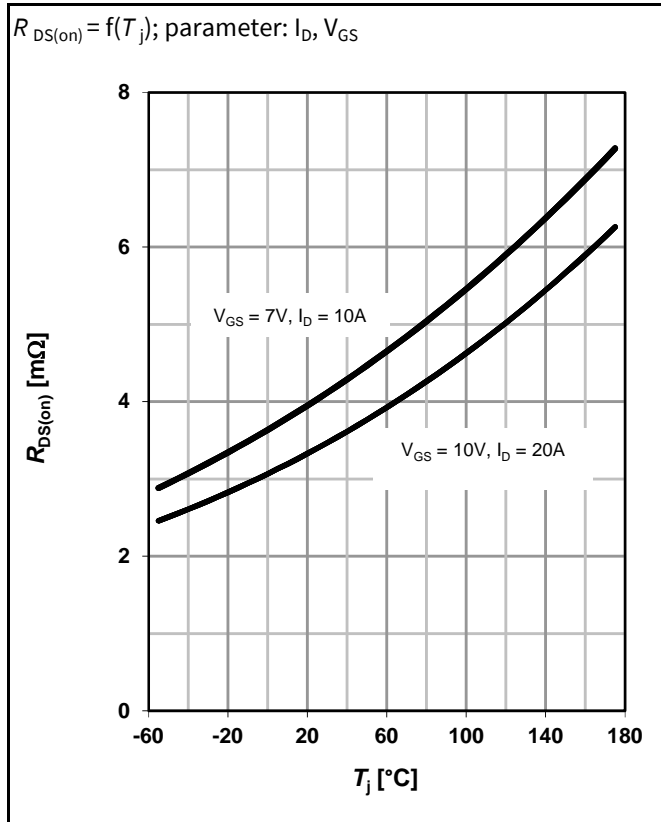

9 Typ. gate threshold voltage

$V_{GS(th)} = f(T_j)$; $V_{GS} = V_{DS}$; parameter: I_D

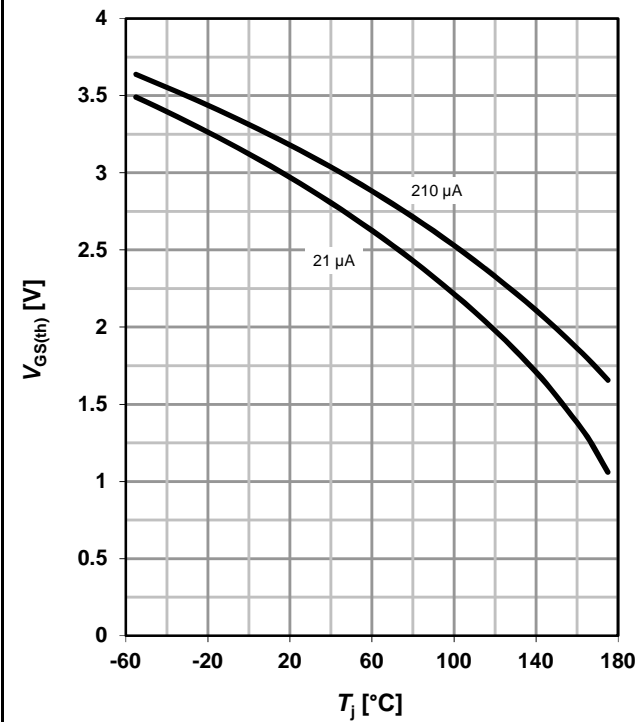

10 Typ. capacitances

$C = f(V_{DS})$; $V_{GS} = 0 V$; $f = 1 MHz$

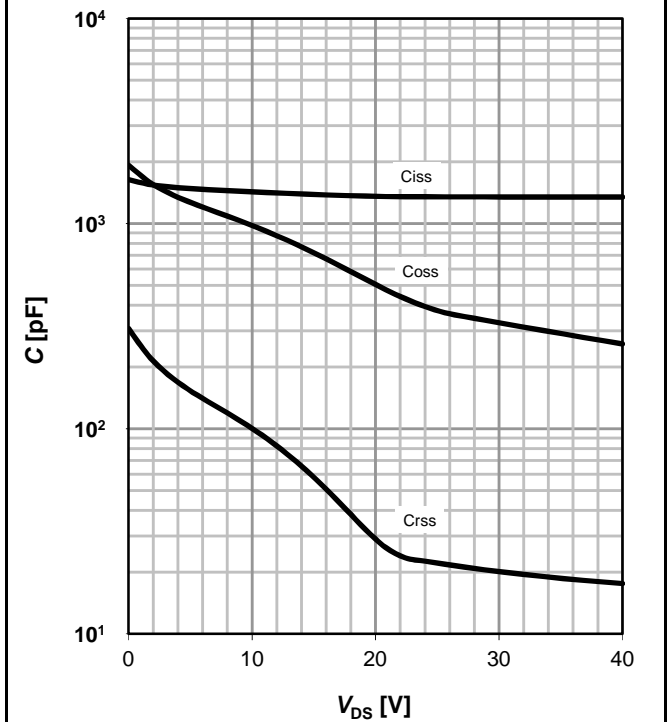

11 Typical forward diode characteristics

$I_F = f(V_{SD})$; parameter: T_j

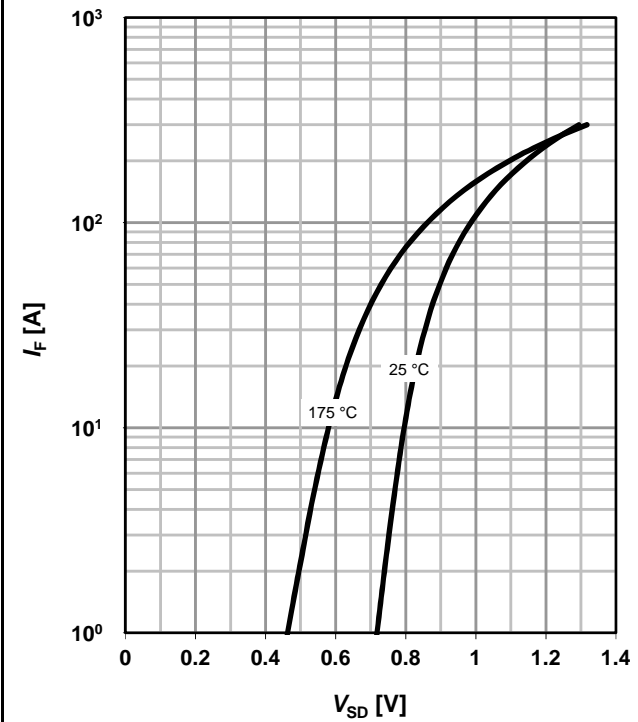

12 Typ. avalanche characteristics

$I_{AS} = f(t_{AV})$; parameter: $T_{j(start)}$

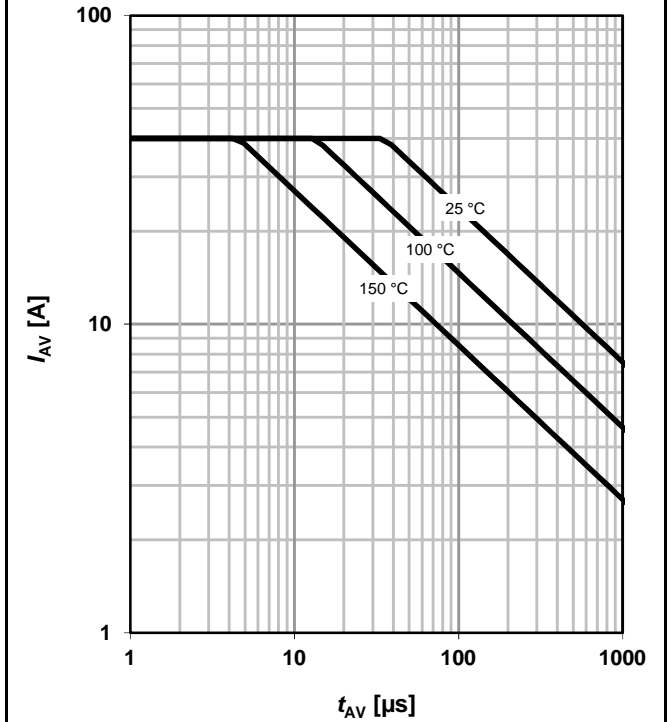

13 Typical avalanche energy

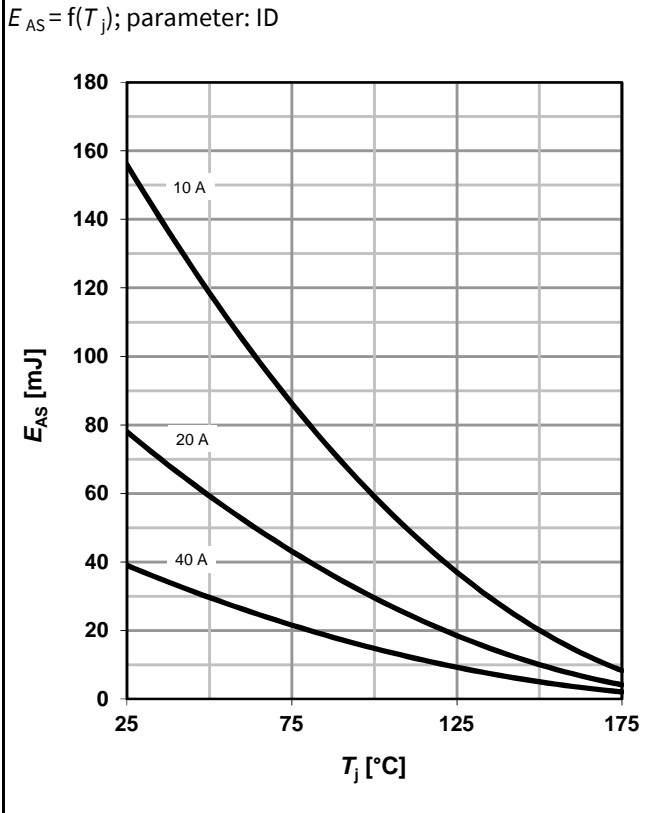

14 Drain-source breakdown voltage

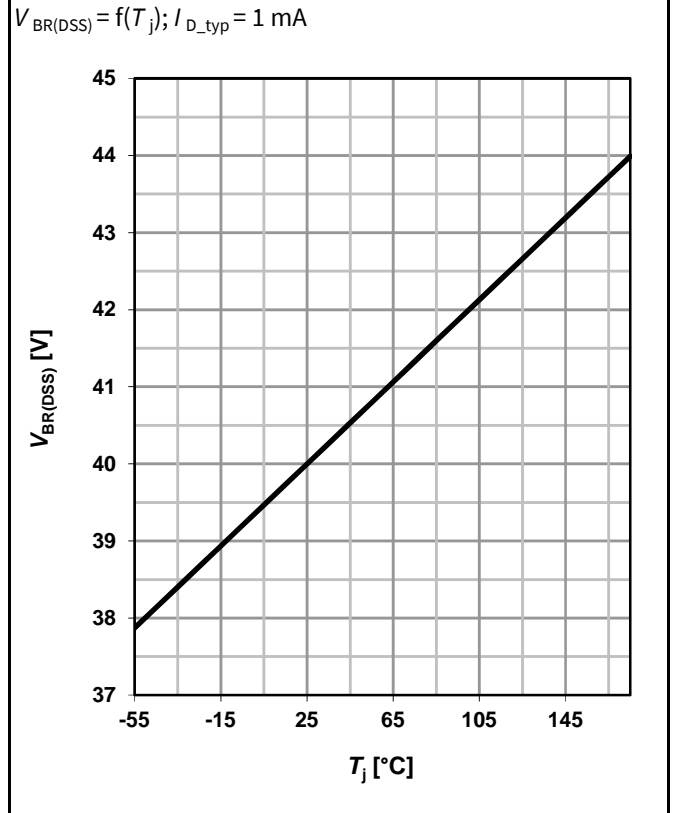

15 Typ. gate charge

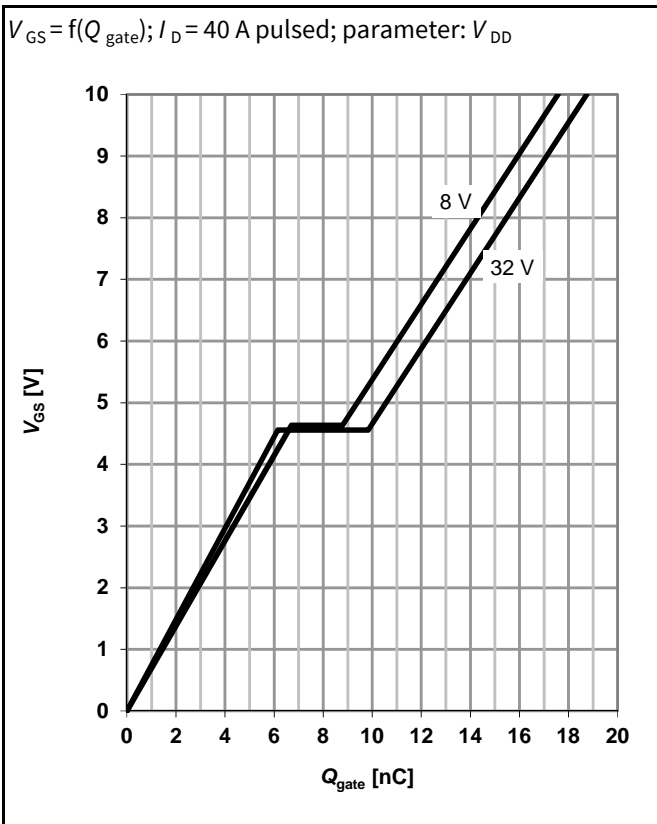

16 Gate charge waveforms

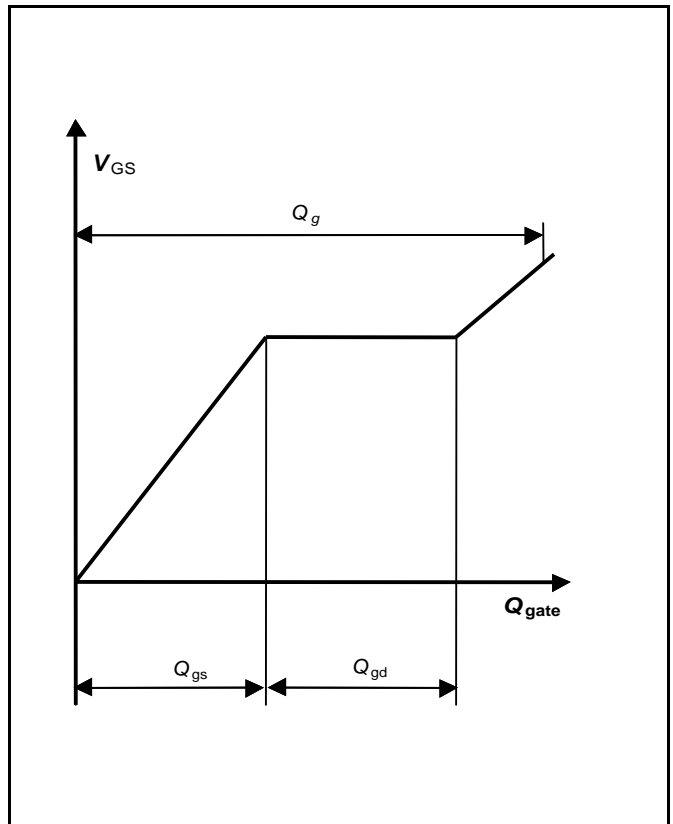

Package Outline

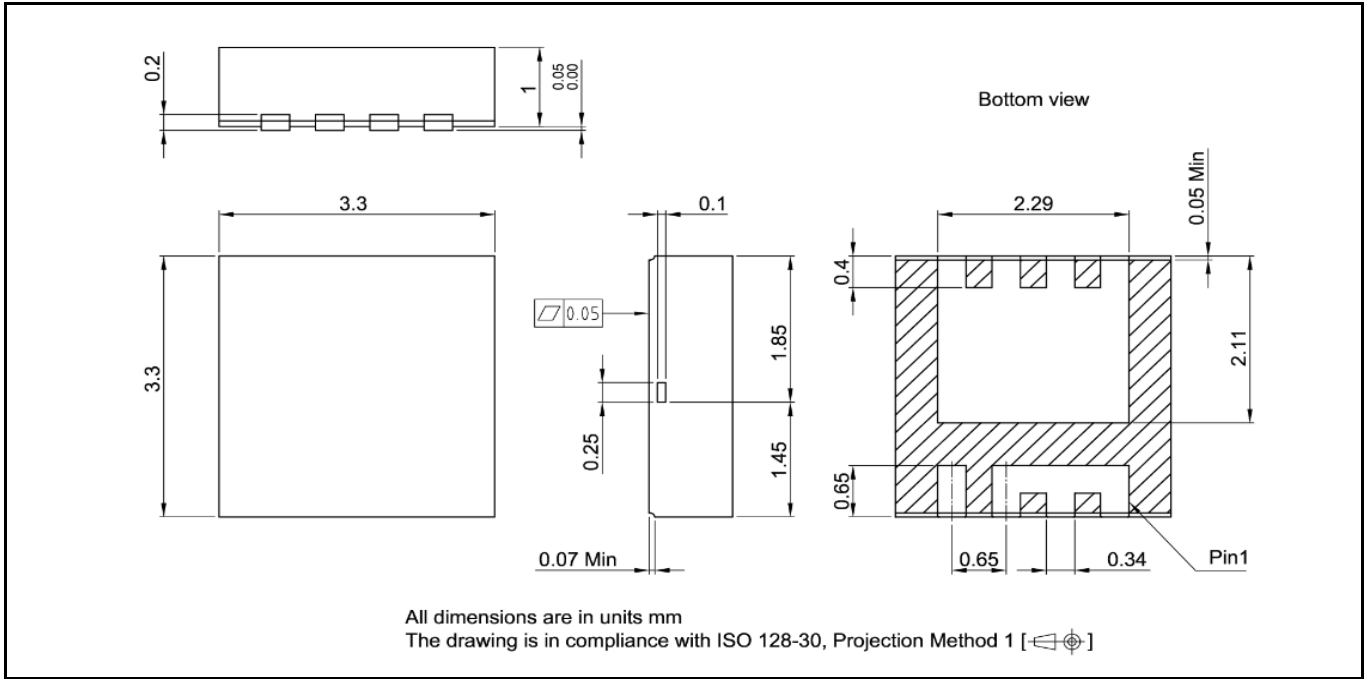

Footprint

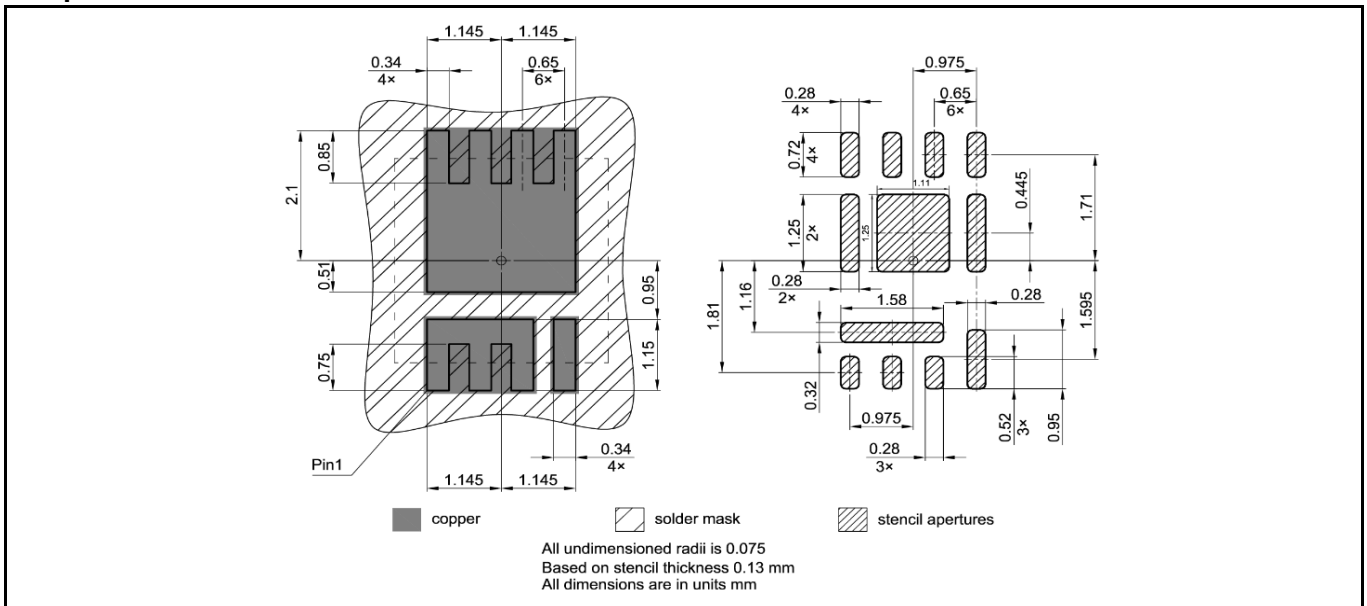

Packaging

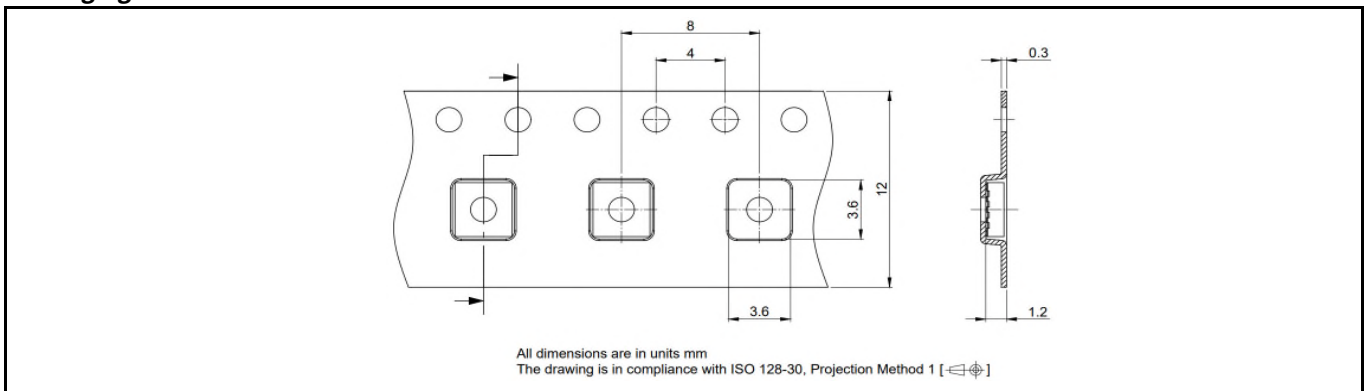

Revision History

Revision	Date	Changes
Revision 1.0	04.05.2021	final data sheet
Revision 1.1	07.05.2021	marking (page 1)
Revision 1.2	27.01.2022	update image for pin layout (page 1), update thermal characteristics (page 4)

Trademarks

All referenced product or service names and trademarks are the property of their respective owners.

Edition 2021-05-04

Published by

Infineon Technologies AG

81726 Munich, Germany

© 2021 Infineon Technologies AG

All Rights Reserved.

Do you have any questions about any aspect of this document?

Email: erratum@infineon.com

IMPORTANT NOTICE

The information given in this document shall in no event be regarded as a guarantee of conditions or characteristics ("Beschaffenheitsgarantie").

With respect to any examples, hints or any typical values stated herein and/or any information regarding the application of the product, Infineon Technologies hereby disclaims any and all warranties and liabilities of any kind, including without limitation warranties of non-infringement of intellectual property rights of any third party.

In addition, any information given in this document is subject to customer's compliance with its obligations stated in this document and any applicable legal requirements, norms and standards concerning customer's products and any use of the product of Infineon Technologies in customer's applications. The data contained in this document is exclusively intended for technically trained staff. It is the responsibility of customer's technical departments to evaluate the suitability of the product for the intended application and the completeness of the product information given in this document with respect to such application.

For further information on technology, delivery terms and conditions and prices, please contact the nearest Infineon Technologies Office (www.infineon.com).

WARNINGS

Due to technical requirements products may contain dangerous substances. For information on the types in question please contact the nearest Infineon Technologies Office.

Except as otherwise explicitly approved by Infineon Technologies in a written document signed by authorized representatives of Infineon Technologies, Infineon Technologies' products may not be used in any applications where a failure of the product or any consequences of the use thereof can reasonably be expected to result in personal injury.