



TAOGLAS®



Datasheet

Accura GNSS L1/L5 Stacked Patch Multi-Band Antenna

Part No:
GVLB258.A

Description:

Single Feed Stacked Patch Antenna for GNSS L1 / L5, GLONASS, BeiDou B1

Features:

Single Feed Stacked Patch Assembly

Covering Bands

- GPS L1 & L5
- BeiDou B1
- Galileo E1 & E5a
- GLONASS G1
- IRNSS L5

Pin Mount

Dimensions: 25*25*8.12mm

RoHS & REACH Compliant

1. Introduction	3
2. Specifications	4
3. Antenna Characteristics	6
4. Radiation Patterns	9
5. Field Test Results	14
6. Mechanical Drawing	15
7. Antenna Integration Guide	17
8. Solder Reflow Profile	21
9. Packaging	22
<hr/>	
Changelog	23

Taoglas makes no warranties based on the accuracy or completeness of the contents of this document and reserves the right to make changes to specifications and product descriptions at any time without notice. Taoglas reserves all rights to this document and the information contained herein. Reproduction, use or disclosure to third parties without express permission is strictly prohibited.



1. Introduction



The Taoglas Accura GVLB258.A, is a multi-band GPS, BeiDou/Compass and IRNSS, high-performance directional antenna for high precision GPS and BeiDou accuracy and fast positioning. It utilizes a 25*25*8mm advanced wide-band dual stacked ceramic patch antenna with optimized gain for GPS L1/L5, Galileo, GLONASS and BeiDou bands.

Typical Applications Include:

- RTK
- Navigation
- Wearables
- Security
- Transportation
- Autonomous Vehicles
- Agriculture

The GVLB258.A has been tuned and tested on a 70 x 70 mm ground plane and exhibits excellent radiation patterns. The GVLB258.A has been optimised to cover the bands required for the next generation of L1/L5 GNSS receivers that are currently on the market.

Patch antennas can be specifically tuned to customer-specific device environments, subject to NRE and MOQ. Contact your regional Taoglas customer support team to request these services or additional support to integrate and test this antenna's performance in your device.

2. Specifications

GNSS Frequency Bands Covered						
GPS	L1	L2	L5			
	■	□	■			
GLONASS	G1	G2	G3			
	■	□	□			
Galileo	E1	E5a	E5b	E6		
	■	■	□	□		
BeiDou	B1	B2a	B2b	B3		
	■	□	□	□		
QZSS (Regional)	L1	L2C	L5	L6		
	■	□	■	□		
IRNSS (Regional)	L5					
	■					
SBAS	L1/E1/B1	L5/B2a/E5a	G1	G2	G3	
	■	■	■	□	□	

■ GNSS Frequency Bands Covered. □ GNSS Frequency Bands Not Covered.

*SBAS systems: WASS(L1/L5), EGNOS(E1/E5a), SDCM(G1/G2/G3), SNAS(B1,B2a), GAGAN(L1/L5), QZSS(L1/L5), KAZZ(L1/L5).

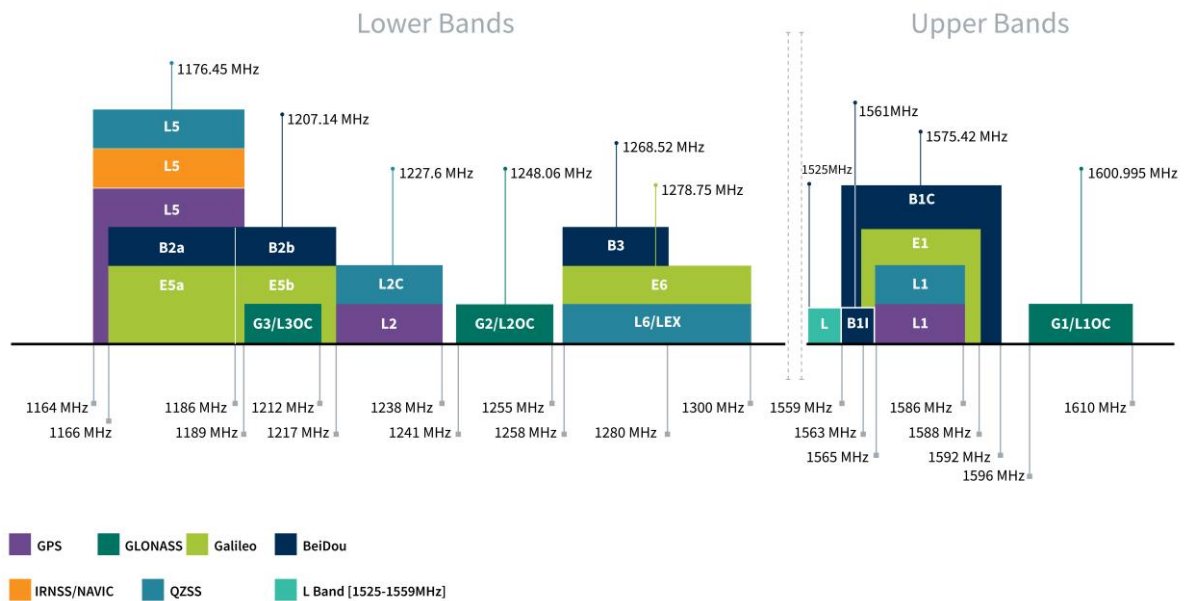

GNSS Bands and Constellations

Electrical				
Frequency (MHz)	GPS L5 / GLONASS E5a / IRNSS L5 / BeiDou B2a	BeiDou B1	GPS L1 / Galileo E1	GLONASS G1
	1166-1186	1559-1563	1563-1587	1593-1610
Efficiency (%)	58.5	68.5	60.7	62.5
Peak Gain(dBi)	2.31	2.94	2.87	3.08
Average Gain(dB)	-2.33	-1.64	-2.17	-2.04
Polarization	R.H.C.P.			
Radiation Pattern	Omni			
Impedance	50 Ω			

Mechanical	
Planner Dimension	25*25*8mm
Ground Plane	70*70mm
Connection Type	Pin & Adhesive Mount
Weight	18g

Environmental	
Temperature Range	-40°C to 85°C
Humidity	Non-condensing 65°C 95% RH

3. Antenna Characteristics

3.1 Return Loss

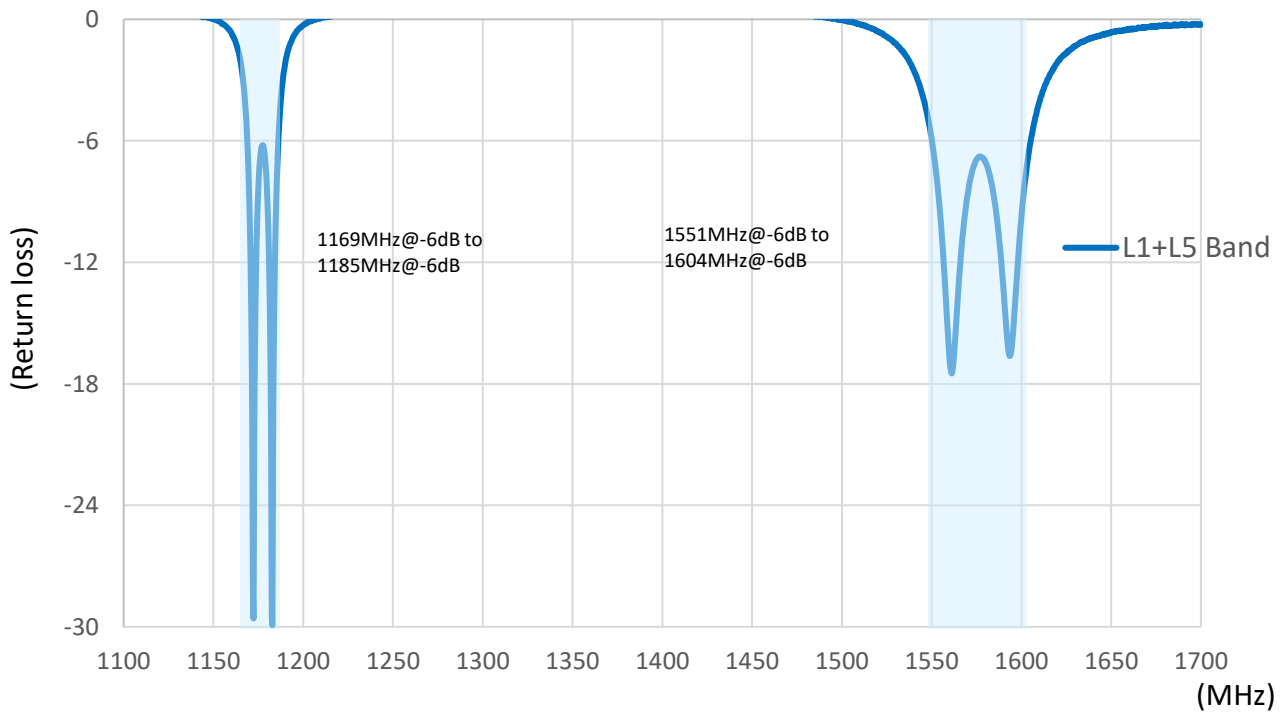

3.2 Efficiency

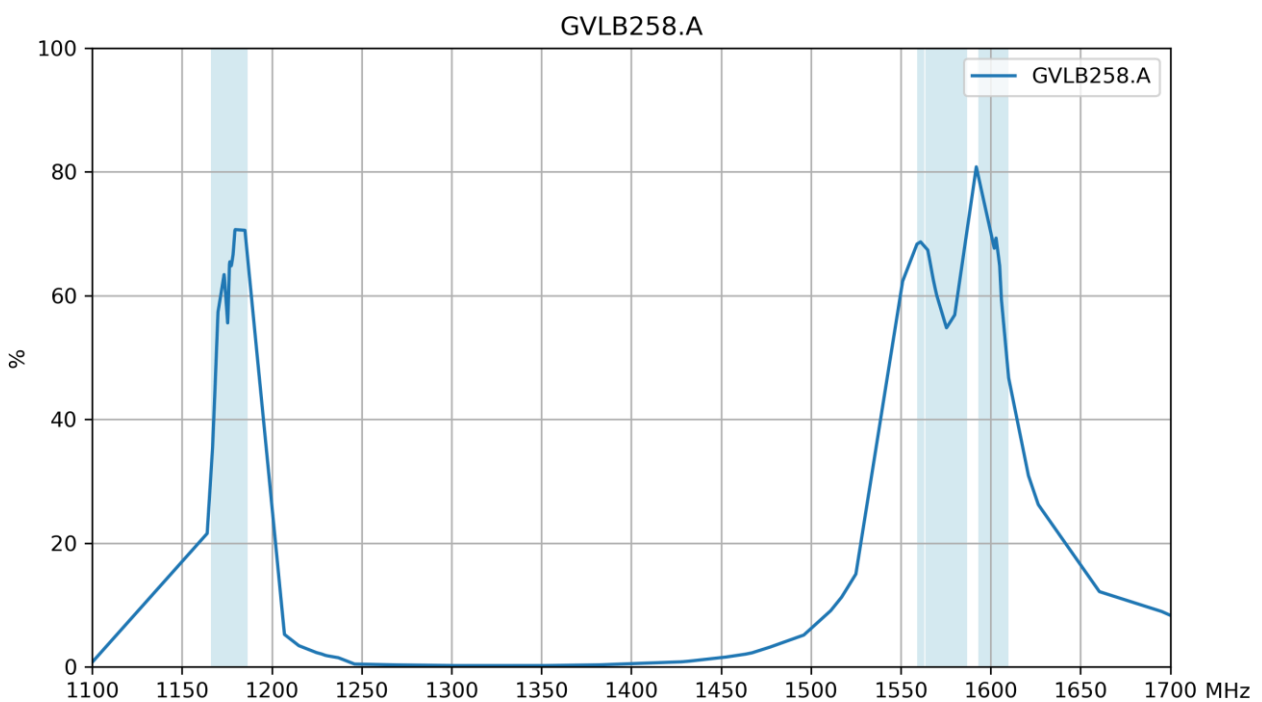

3.3 Average Gain

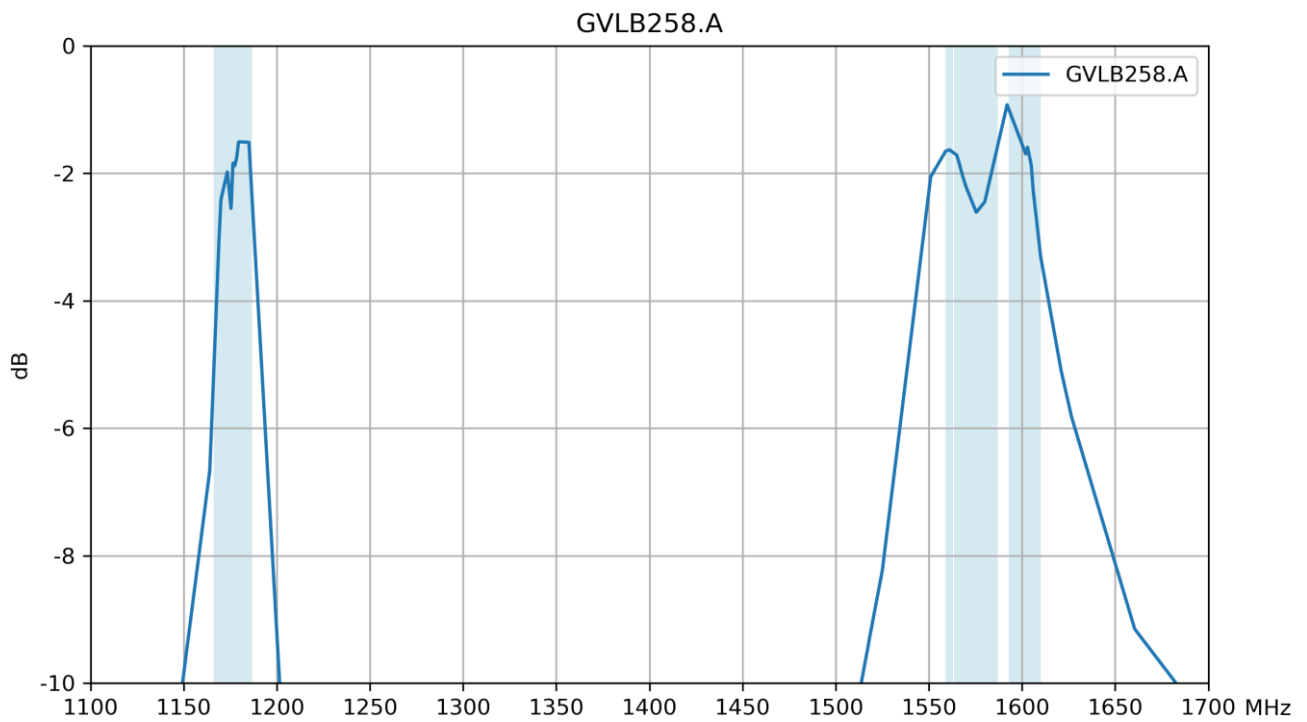

3.4 Peak Gain

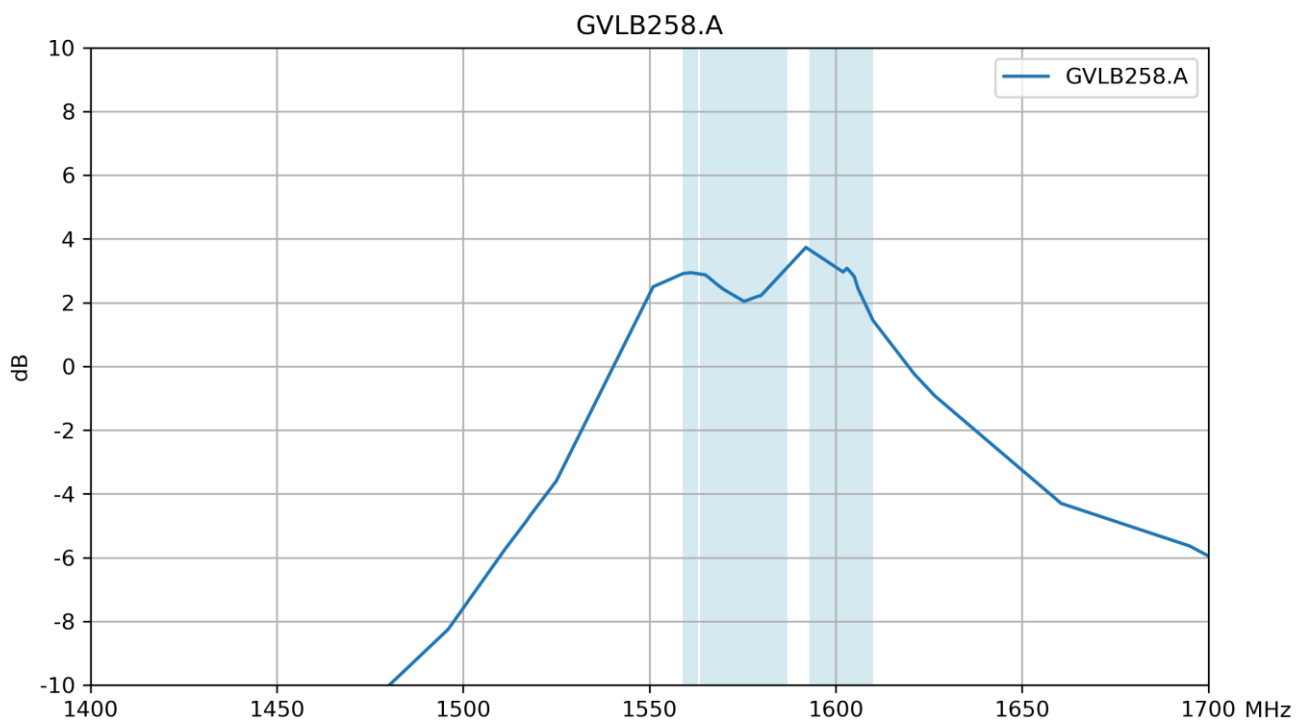

3.5 Axial Ratio – X-Z

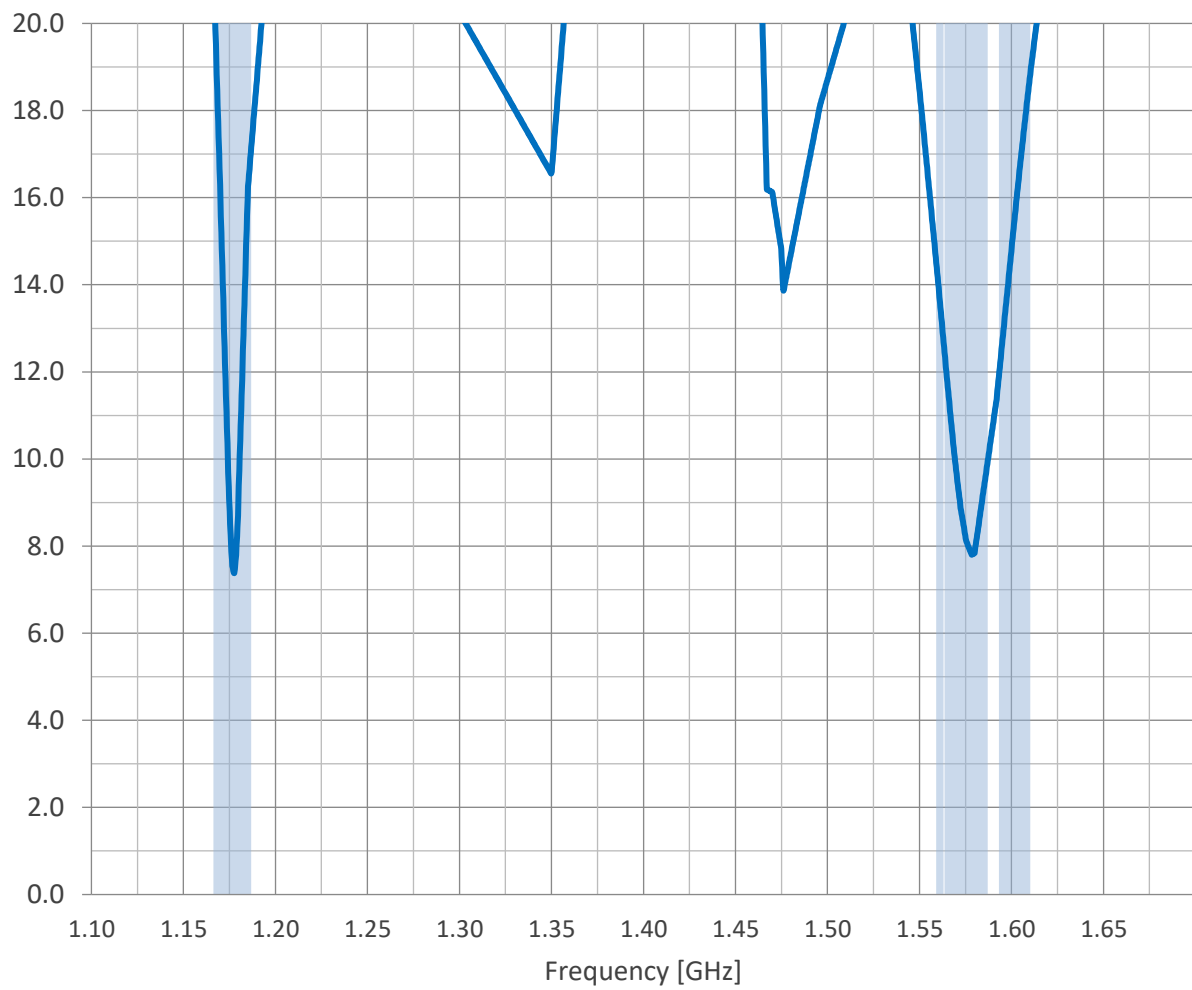

4. Radiation Patterns

4.1 Test Setup

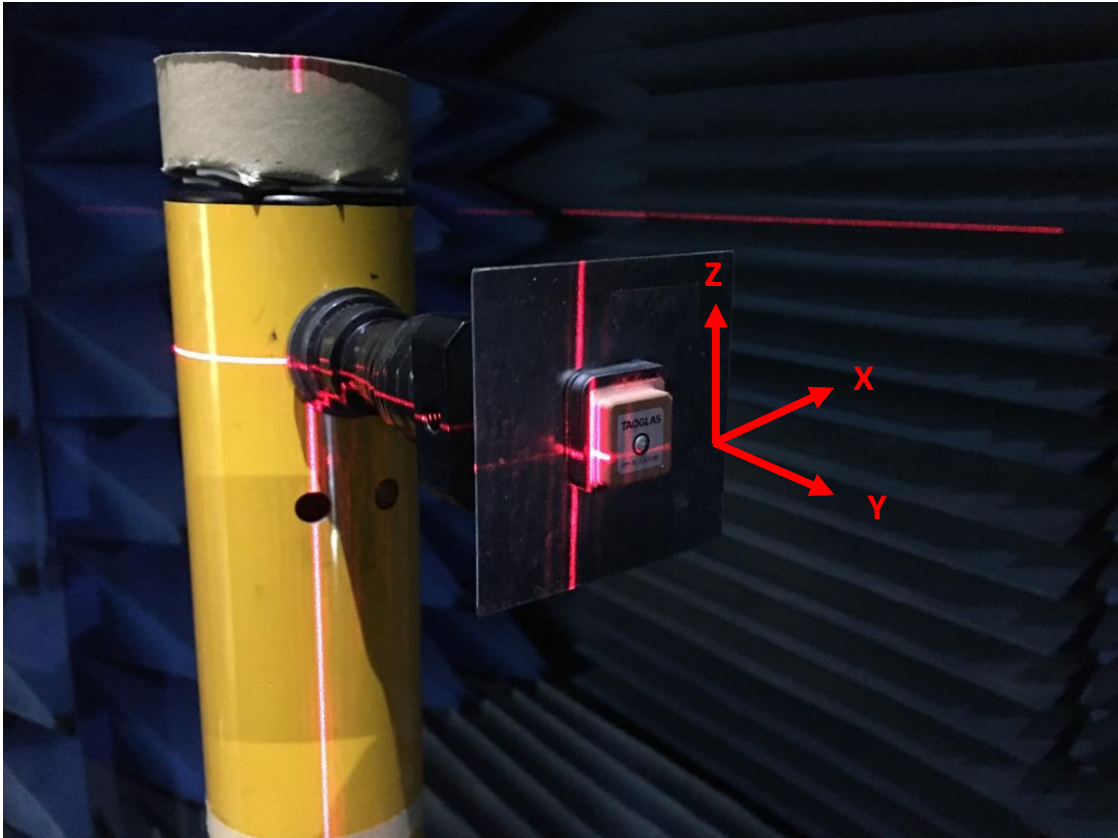

Tested on 70*70mm Ground Plane Evaluation Board

4.2 Radiation Patterns

1176MHz

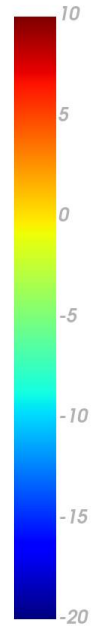
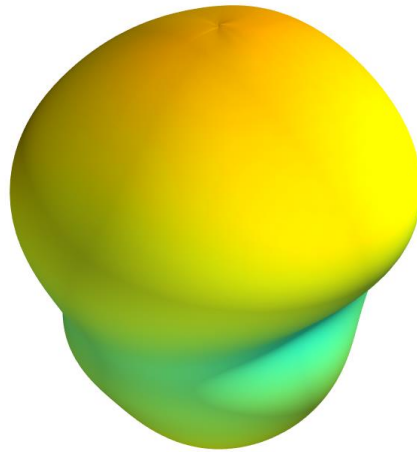

XY Plane

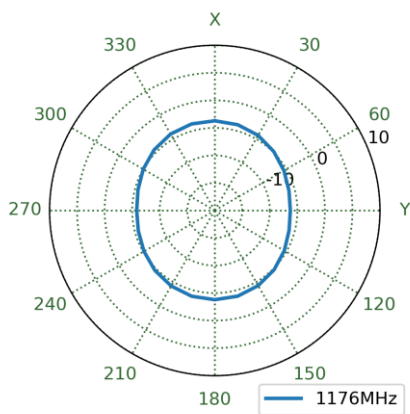

XZ Plane

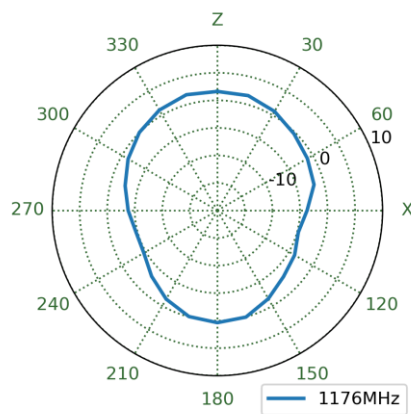

YZ Plane

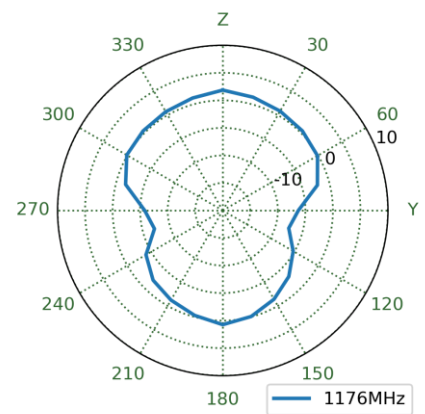

1561MHz

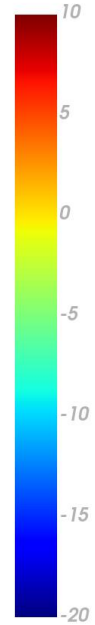
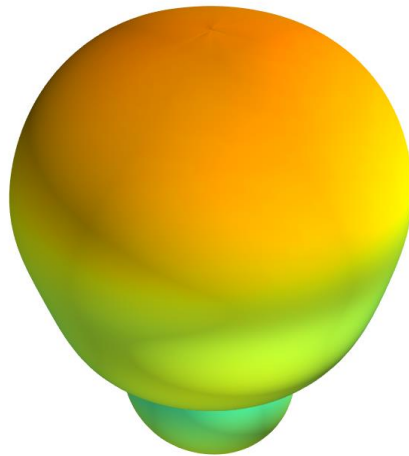

XY Plane

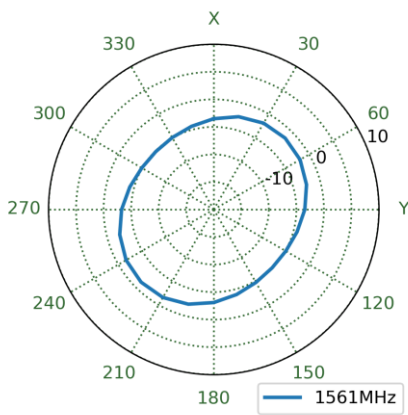

XZ Plane

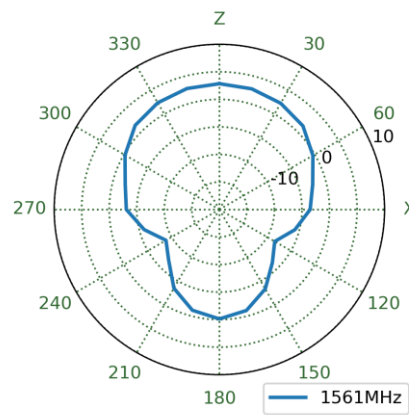

YZ Plane

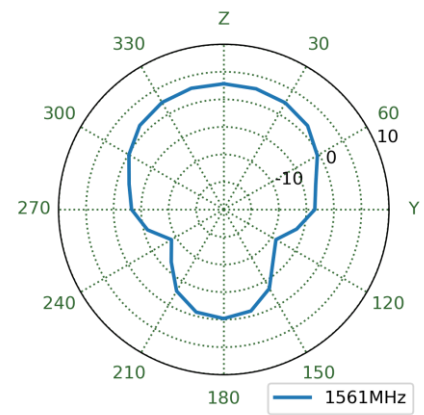

1575MHz

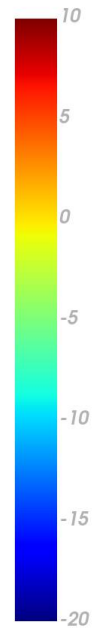
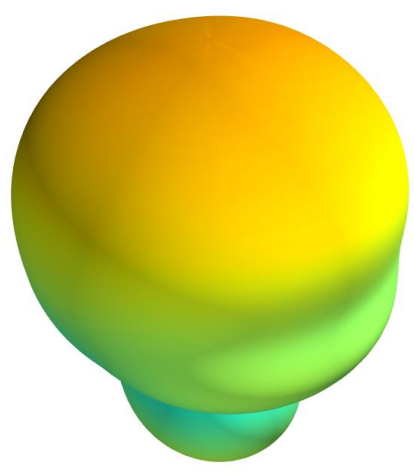

XY Plane

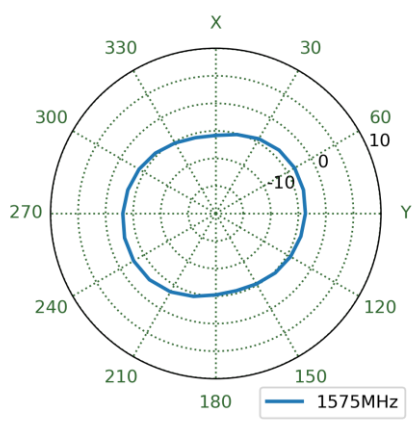

XZ Plane

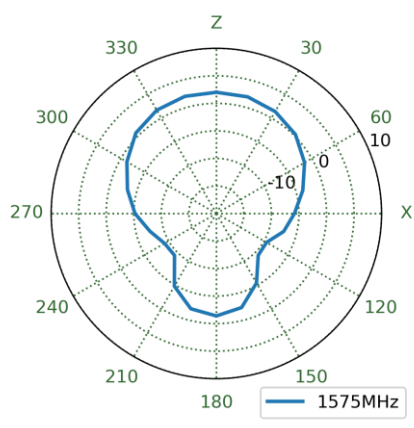

YZ Plane

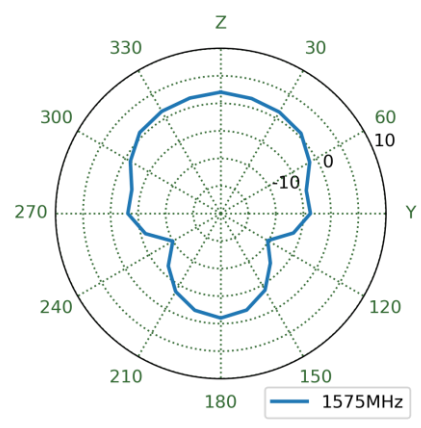

1602MHz

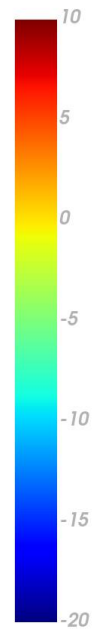
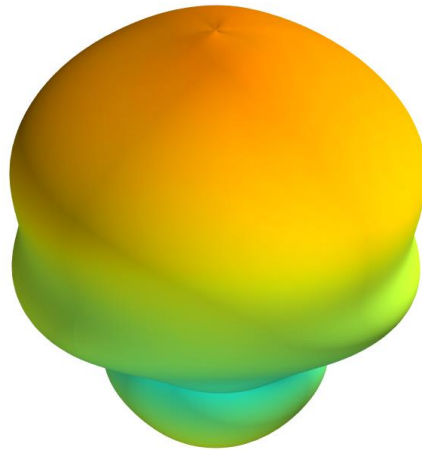

XY Plane

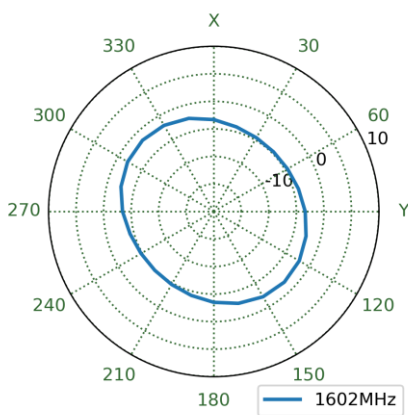

XZ Plane

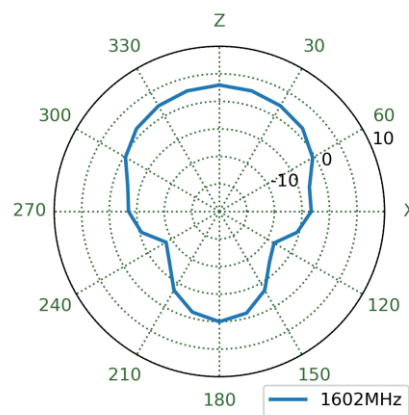

YZ Plane

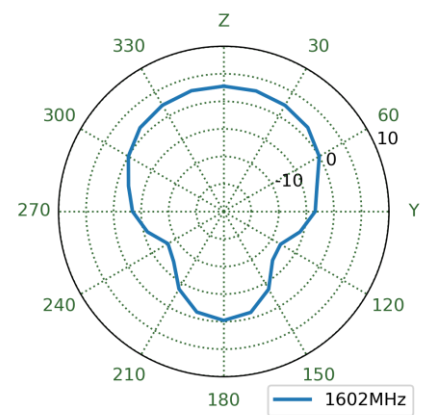

5. Field Test Results

This section outlines the field test result for GVLB258.A antenna. The test was performed when the antenna was mounted on a static rooftop test set up in an open sky environment for a minimum of **6 hours**.

Taoglas will show the field test results using the following receivers:

5.1 Ublox NEO-F9P-15B

Receiver features:

- Multi-band GNSS: GPS / QZSS (L1C/A, L5) GLONASS (L1OF) Galileo (E1-B/C, E5a) BeiDou (B1I, B2a) NavIC (SPS-L5)
- Multi-band PPP-RTK with fast convergence times and reliable performance
- Nav. update rate RTK up to 25 Hz
- Position accuracy = RTK 0.01 m + 1 ppm CEP

Positioning Accuracy Table (2D Accuracy)					
Test Condition	DRMS(cm)	CEP (50%)	DRMS (68%)	2DRMS (95-98.2%)	TTFF (sec)
70x70mm Ground Plane	PPP-RTK DISABLED	44.91	53.99	107.98	25
	PPP-RTK ENABLED	9.04	11.71	23.42	26

*The RTK correction service used in previous measurements provides superior corrections compared to the PPP-RTK service used for measurements on the NEO-F9P.

PPP-RTK Availability 70x70 mm ground plane

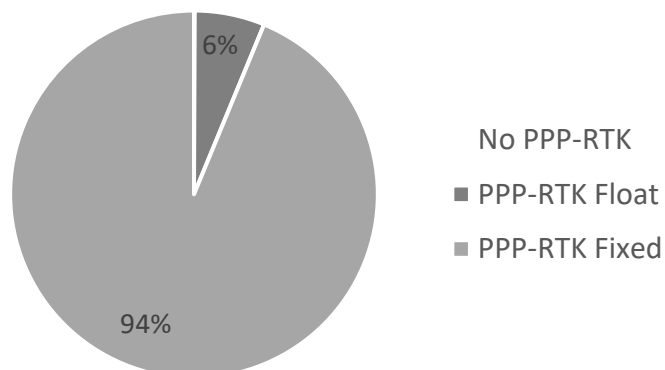

6. Mechanical Drawing (Units: mm)

ISO NO.: EDW-21-8-0598

STATE: Release

NOTES: 1. Double Sided Adhesive Area 2. Soldermask Area

REV.	DESCRIPTION	ENG.	APPROVED	DATE
001	Initial Design	Aron Yan	Wing	2021/05/06

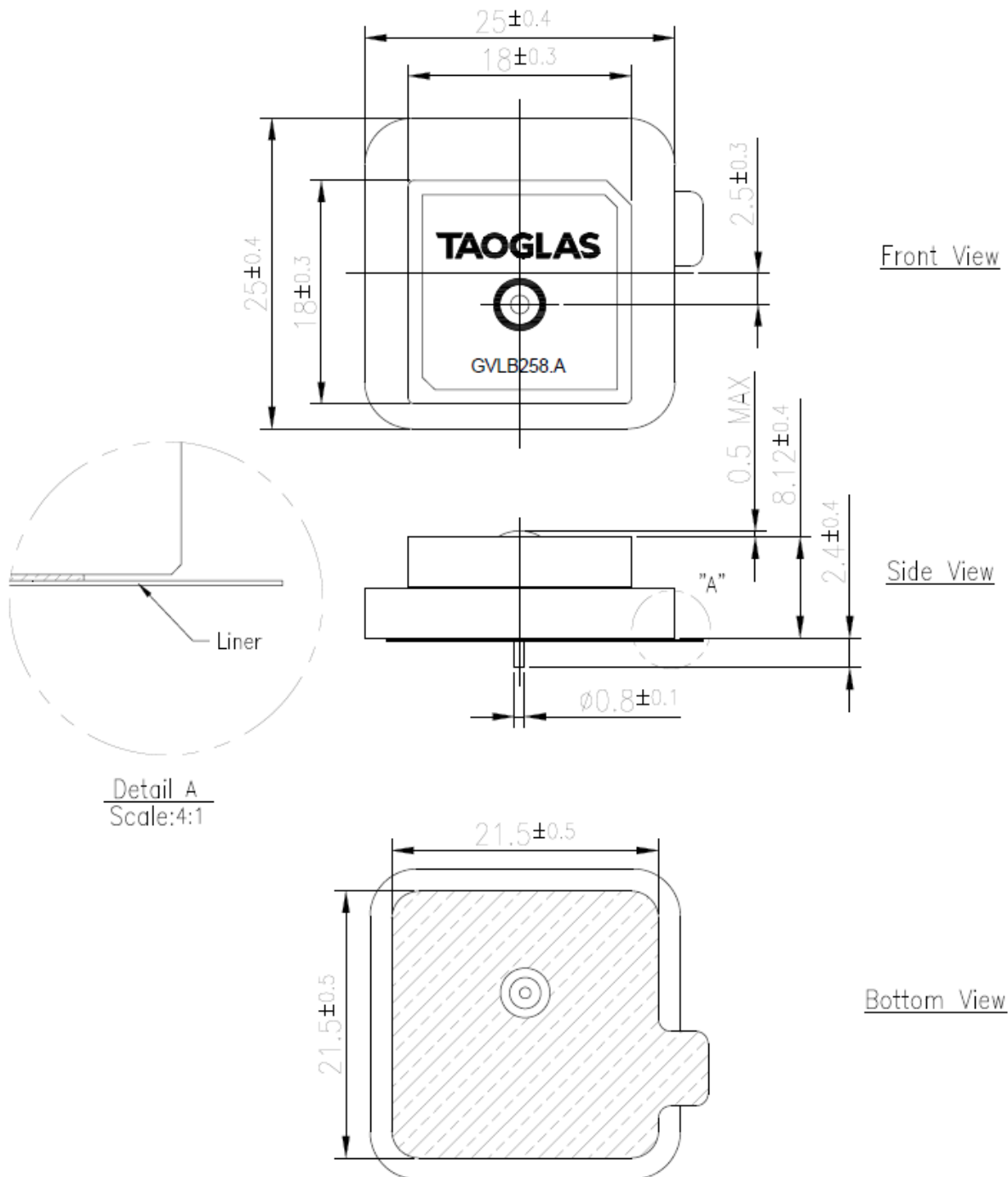

	Name	Material	Finish	QTY
1	Patch(18*18*4)	Ceramic	Clear	1
2	Patch(25*25*4)	Ceramic	Clear	1

6.1 Footprint

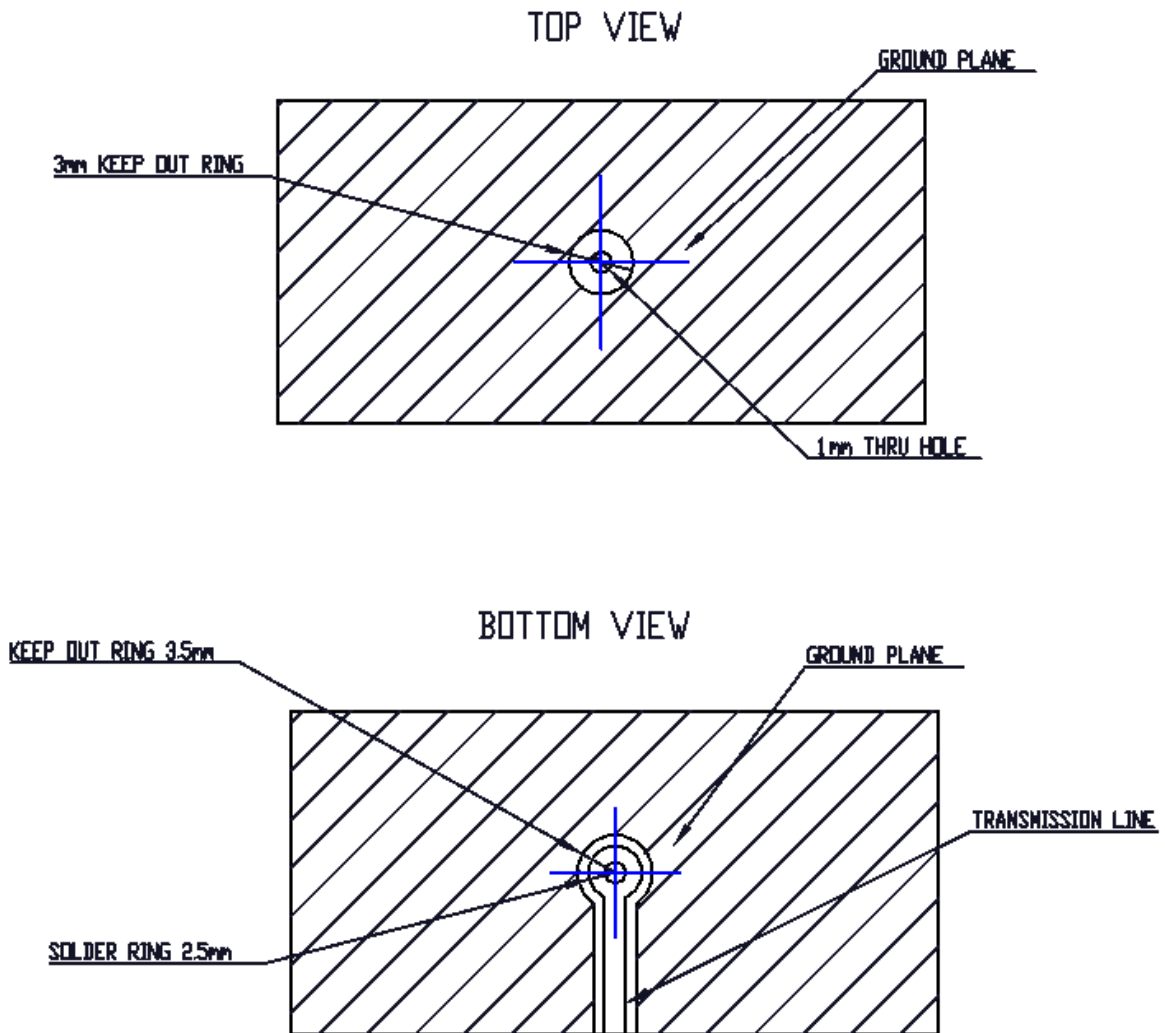

7. Antenna Integration Guide

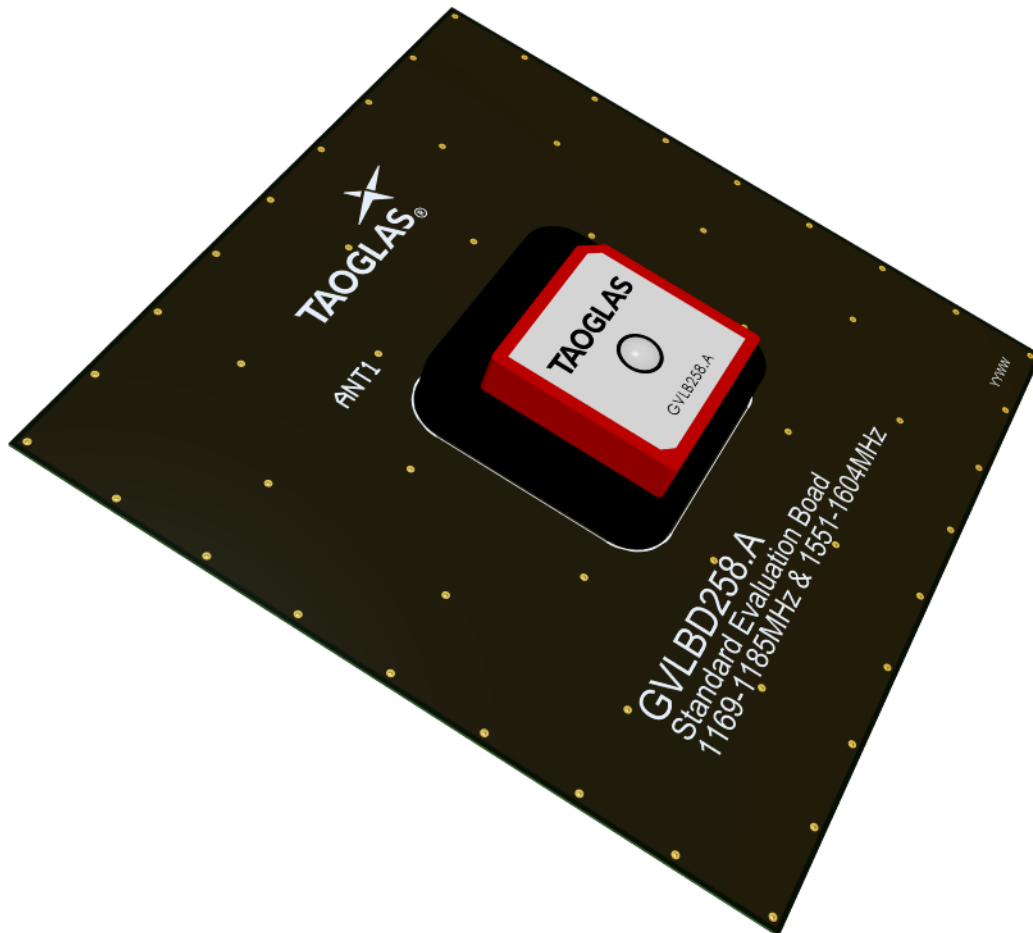

7.1 Schematic Symbol and Pin Definition

The circuit symbol for the antenna is shown below. The antenna has 1 pin as indicated below.

Pin	Description
1	RF Feed

GVLB258.A
ANT1

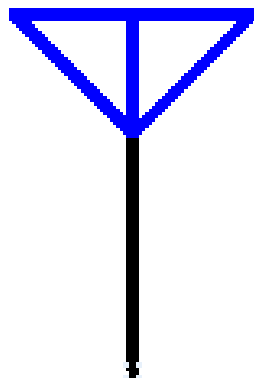

Please note you can download the design files, 3D model, 2D drawings and CST simulation files from the website here:

<https://www.taoglas.com/product/gvlb258-a-accura-gnss-l1-l5-stacked-patch-multi-band-antenna/>

7.2 Antenna Integration

The antenna should be placed at the center of the ground plane with a length and width of 70mm. Maintaining a square symmetric ground plane shape and symmetric environment around the antenna is critical to maintaining the excellent axial ratio and phase center performance shown in this datasheet.



Top Side w/ Solder Mask



Top Side w/o Solder Mask

7.3 PCB Layout

The footprint and clearance on the PCB must comply with the antenna specification. The PCB layout shown in the diagram below demonstrates the antenna footprint.



Topside

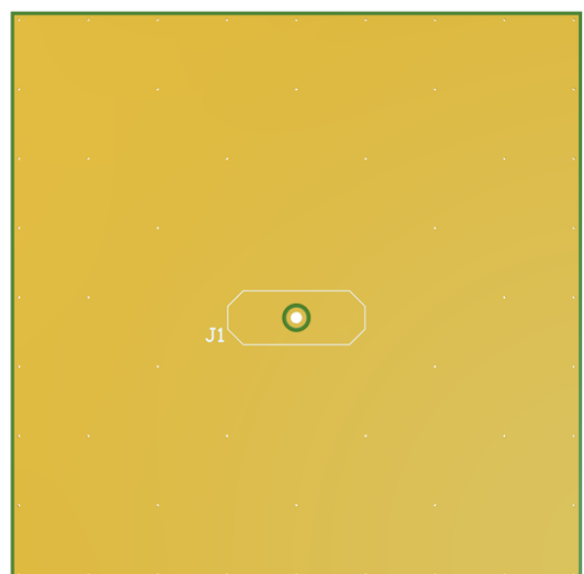

Bottom Side

7.4 Evaluation Board



Topside

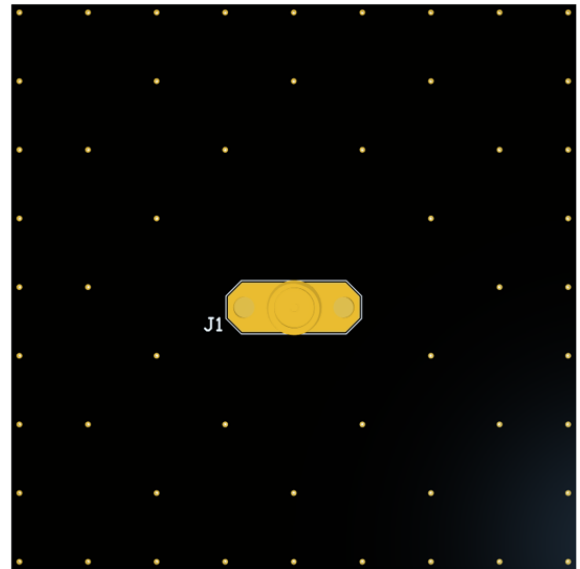

Bottom Side

9. Solder Reflow Profile

The GVLB258.A can be assembled by following the recommended soldering temperatures are as follows:

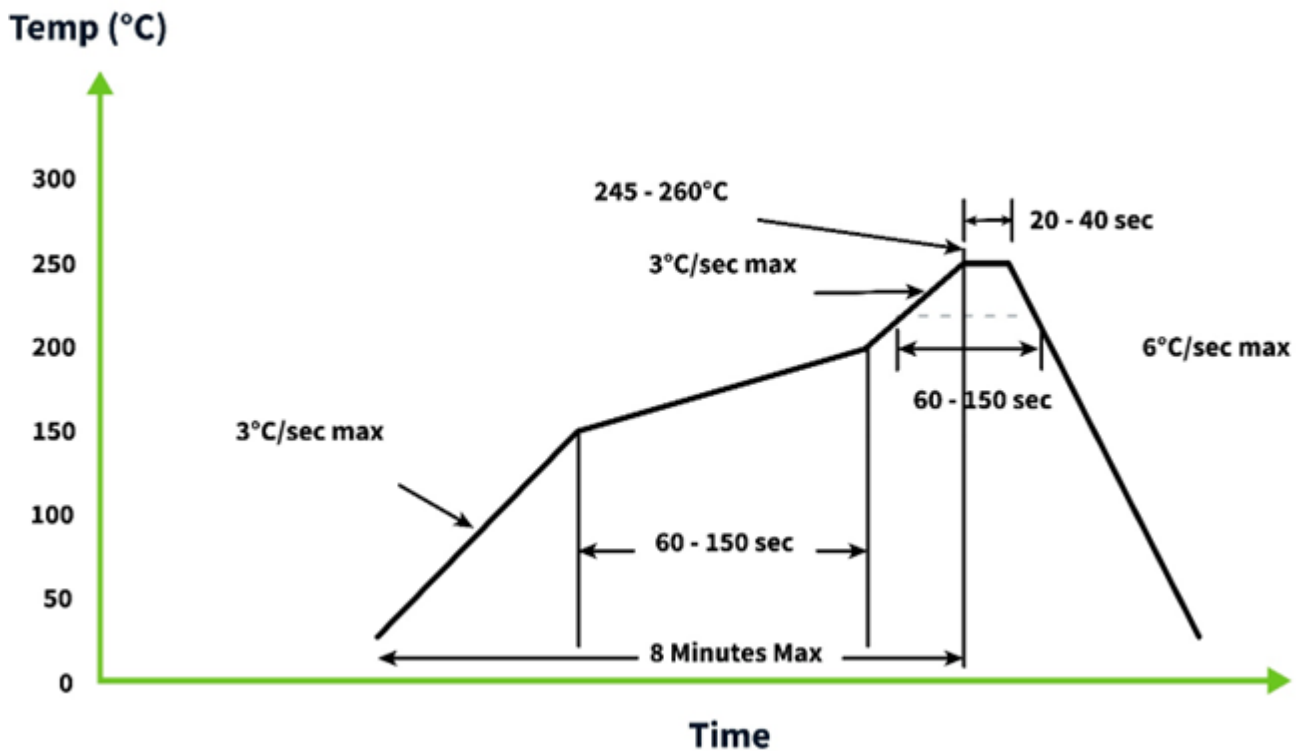

*Temperatures listed within a tolerance of +/- 10° C

Smaller components are typically mounted on the first pass, however, we do advise mounting the GVLB258.A when placing larger components on the board during subsequent reflows.

Note: Soldering flux classified ROL0 under IPC J-STD-004 is recommended.

8. Packaging

24pcs GVLB258.A per Tray
 Tray Dimensions: 255*144*8mm
 Weight: 0.460Kg

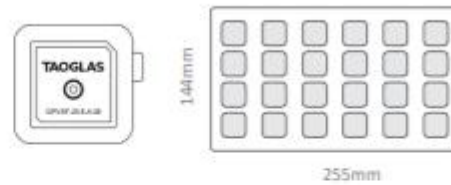

96pcs GVLB258.A per Inner Carton
 Dimensions: 263*154*96mm
 Weight: 2Kg

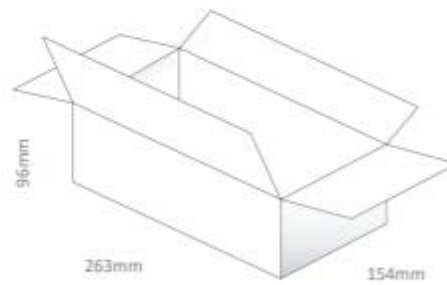

384pcs GVLB258.A per Large Carton
 Dimensions: 327*280*218mm
 Weight: 9Kg

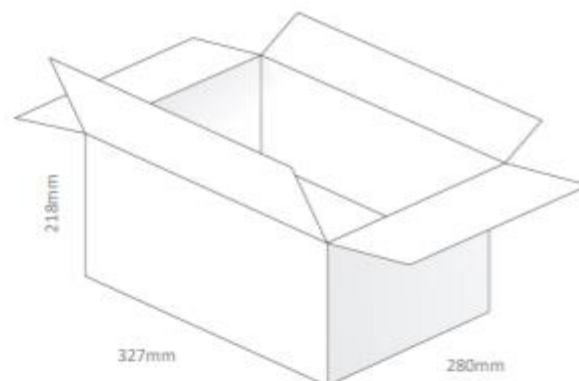

Pallet Dimensions:
 1200*1000*1280mm
 36 Cartons Per Pallet
 9 Cartons Per Layer, 4 Layers

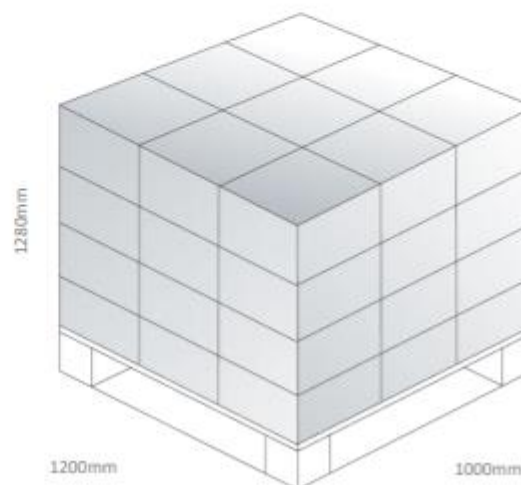

Changelog for the datasheet

SPE-21-8-082 – GVLB258.A

Revision: E (Current Version)

Date:	2023-11-07
Notes:	Added Antenna Integration Guide and solder reflow profile
Author:	Cesar Sousa

Previous Revisions

Revision: D

Date:	2023-07-25
Notes:	Updated Antenna Field Testing
Author:	Gary West

Revision: C

Date:	2022-02-21
Notes:	Updated GNSS Bands & Constellations Graphics
Author:	Cesar Sousa

Revision: B

Date:	2022-08-25
Notes:	Updated Footprint Information and ME Drawing.
Author:	Gary West

Revision: A (Original First Release)

Date:	2021-09-06
Notes:	Initial Release
Author:	Jack Conroy



TAOGLAS®

www.taoglas.com

