



## CW Series 450 MHz

### Single-Band Monopole LTE/5G Antenna

CW Series antennas are rugged, low-cost and easy to install. The single frequency band of CW antennas makes the job of antenna selection simple, with better performance in the target frequency band than in multiband antennas and rejection of signals from unwanted frequencies.

The CW 450 antenna targets 450 MHz to 470 MHz with excellent VSWR, gain and efficiency for LTE and 5G NR bands 72 and 73. This rugged 1/4-wave monopole antenna may be used with plastic or metal enclosures and supports weather-resistant applications.

#### FEATURES

- Outperforms similar multiband solutions
- Durable, flexible main shaft
- Wide bandwidth
- Weather resistant for IP-rated applications<sup>1</sup>
- O-ring compatible base
- Compatible with plastic<sup>2</sup> and metal enclosures
- High gain and efficiency
  - 2.8 dBi, 71% at 450 MHz
  - 2.4 dBi, 65% at 460 MHz
  - 2.1 dBi, 62% at 470 MHz

#### APPLICATIONS

- LTE/5G NR bands 72 and 73
- Hand-held devices
- Internet of Things (IoT) devices

#### ORDERING INFORMATION

Part Number	Description
ANT-450-CW-QW-SMA	450 MHz CW Series antenna with SMA plug (male pin)

Available from Linx Technologies and select distributors and representatives.

#### Notes

1. Use of an O-ring is recommended, IP-ratings cannot be guaranteed
2. With appropriate counterpoise

## ELECTRICAL SPECIFICATIONS

ANT-450-CW-QW-SMA	450 MHz
Frequency Range	450 MHz to 470 MHz
VSWR (max)	1.3
Peak Gain (dBi)	3.4
Average Gain (dBi)	-1.7
Efficiency (%)	72
Polarization	Linear
Radiation	Omnidirectional
Max Power	10 W
Wavelength	1/4-wave
Impedance	50 $\Omega$
Connection	SMA plug (male pin)
Height	167.0 mm (6.57 in)
Weight	18.5 g (0.65 oz)
Operating Temperature	-40 °C to +90 °C

Electrical specifications and plots measured with a 102 mm x 102 mm (4 in x 4 in) reference ground plane.

### VSWR

Figure 1 provides the voltage standing wave ratio (VSWR) across the antenna bandwidth. VSWR describes the power reflected from the antenna back to the radio. A lower VSWR value indicates better antenna performance at a given frequency. Reflected power is also shown on the right-side vertical axis as a gauge of the percentage of transmitter power reflected back from the antenna.

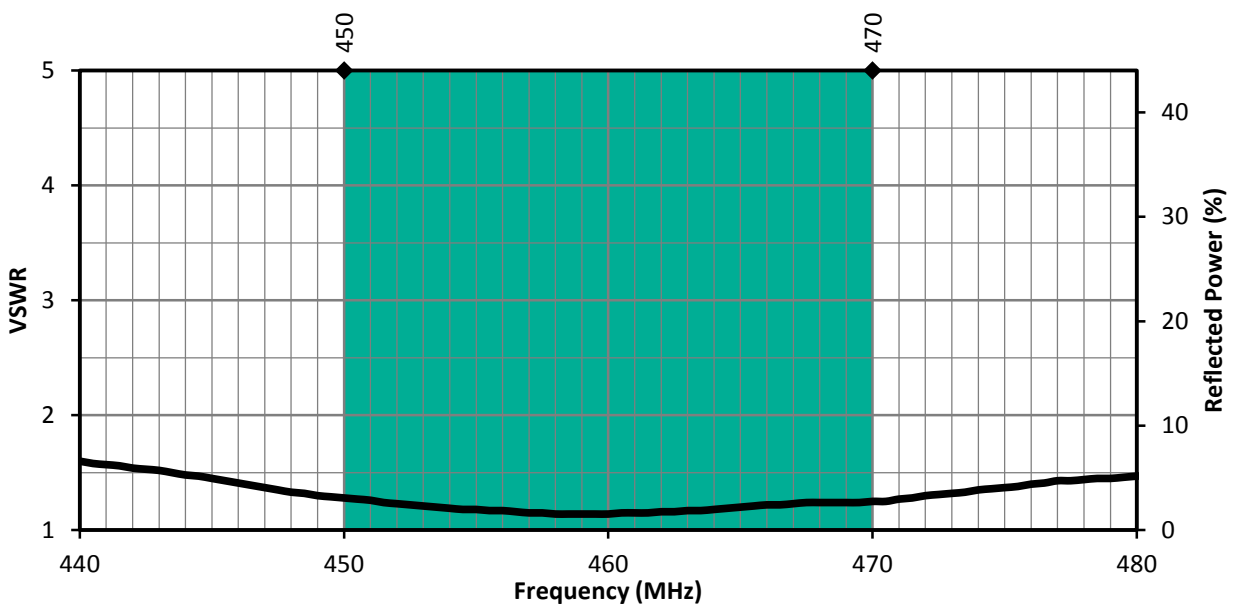

Figure 1. CW 450 MHz Antenna VSWR with Band Highlight

## RETURN LOSS

Return loss (Figure 2), represents the loss in power at the antenna due to reflected signals. Like VSWR, a lower return loss value indicates better antenna performance at a given frequency.

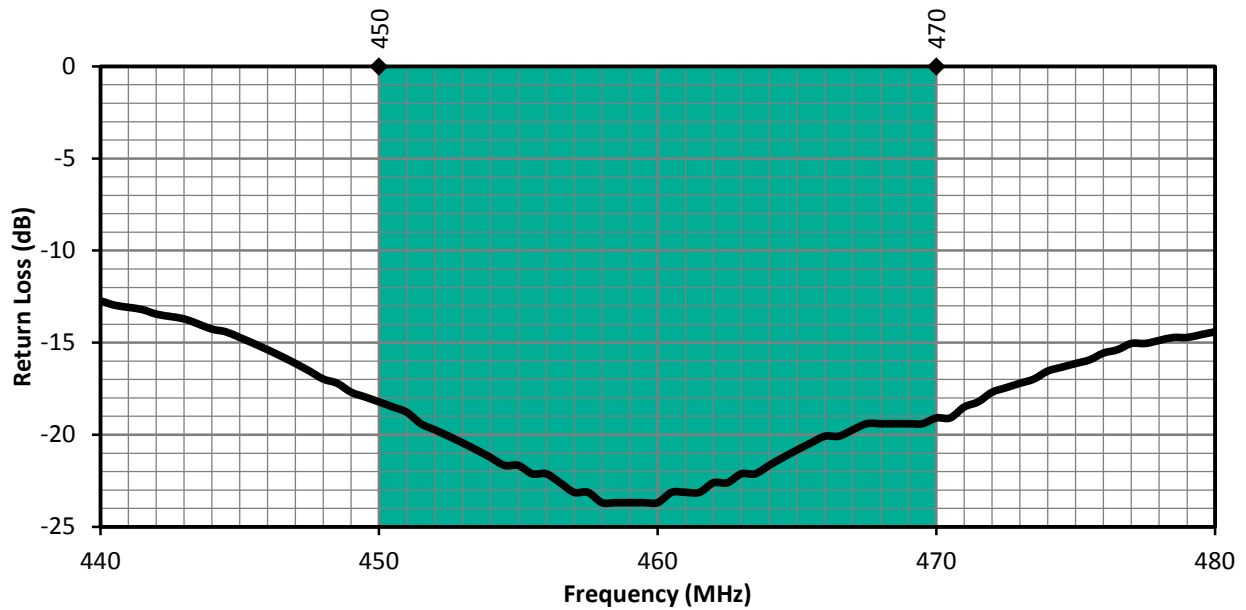

Figure 2. CW 450 MHz Antenna Return Loss with Band Highlight

## PEAK GAIN

The peak gain across the antenna bandwidth is shown in Figure 3. Peak gain represents the maximum antenna input power concentration across 3-dimensional space, and therefore peak performance, at a given frequency, but does not consider any directionality in the gain pattern.

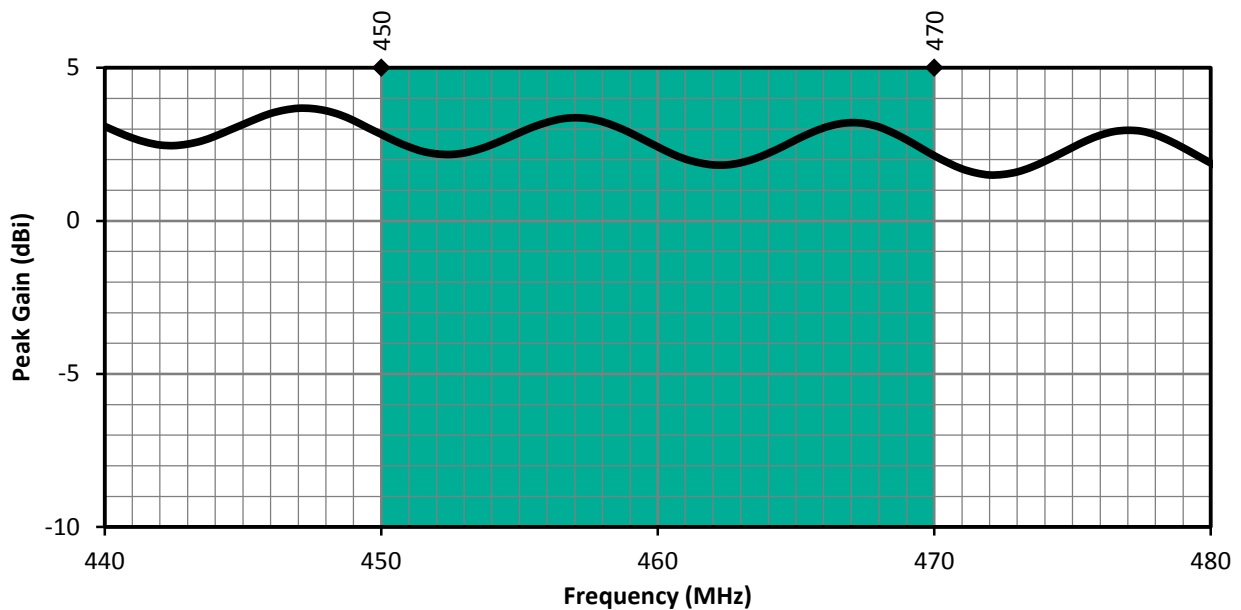

Figure 3. CW 450 MHz Antenna Peak Gain with Band Highlight

## AVERAGE GAIN

Average gain (Figure 4), is the average of all antenna gain in 3-dimensional space at each frequency, providing an indication of overall performance without expressing antenna directionality.

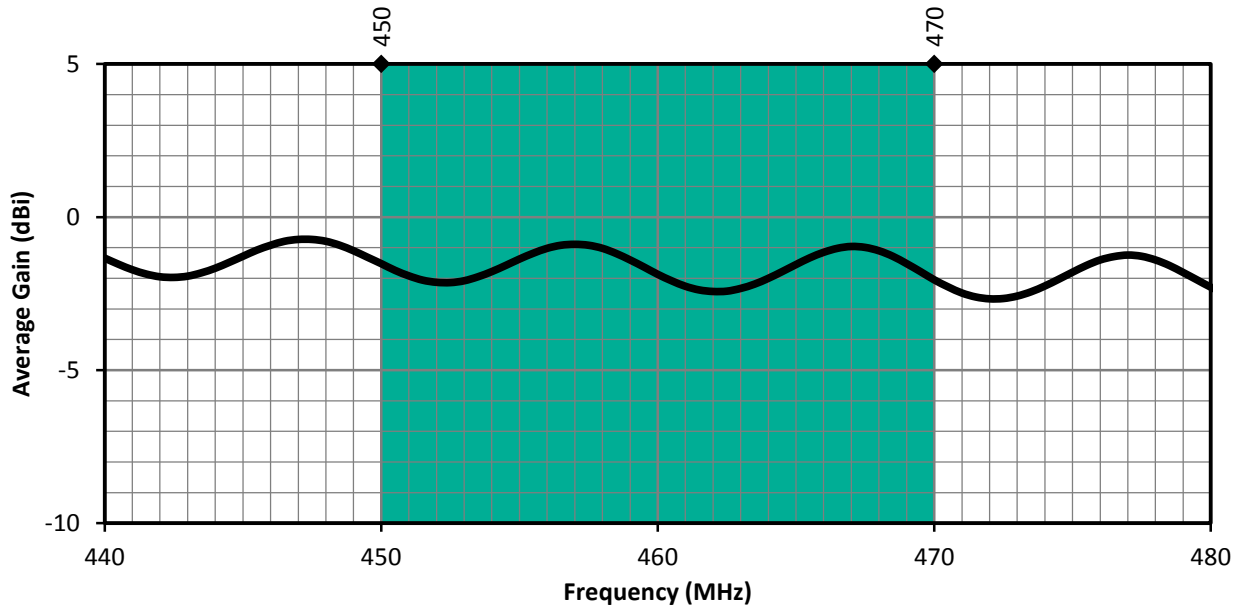

Figure 4. CW 450 MHz Antenna Average Gain with Band Highlight

## RADIATION EFFICIENCY

Radiation efficiency (Figure 5), shows the ratio of power delivered to the antenna relative to the power radiated at the antenna, expressed as a percentage, where a higher percentage indicates better performance at a given frequency.

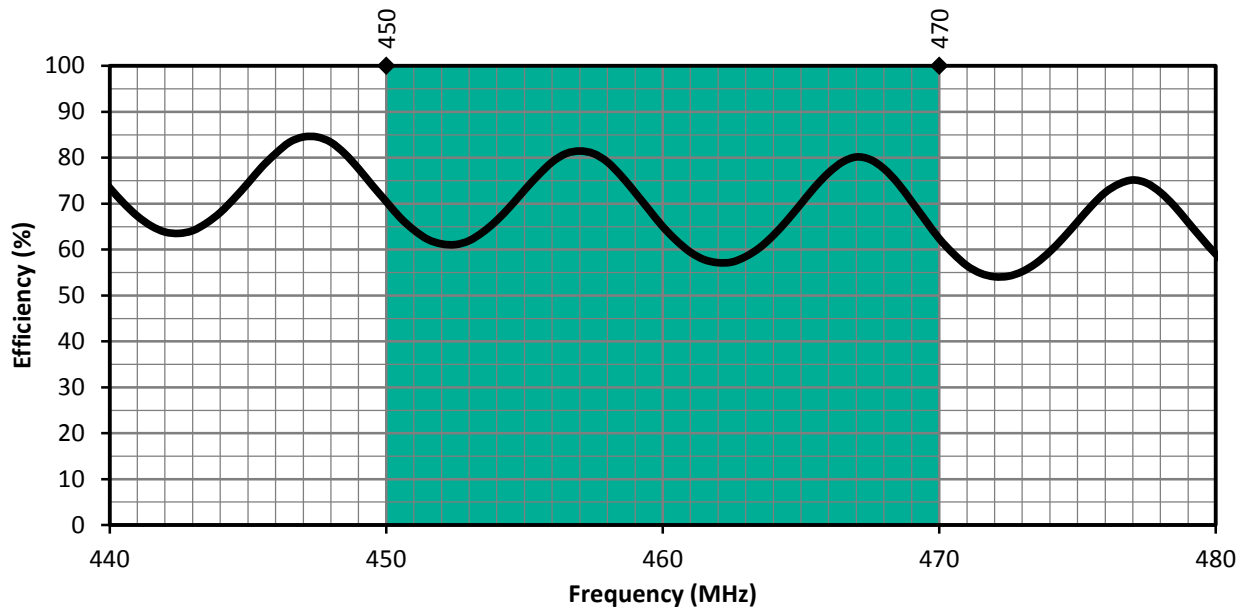

Figure 5. CW 450 MHz Antenna Radiation Efficiency with Band Highlight

## PRODUCT DIMENSIONS

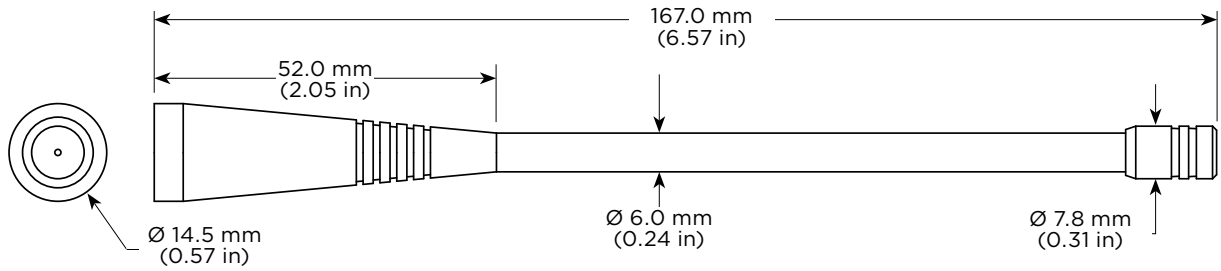

Figure 6. CW 450 MHz Antenna Dimensions

## COUNTERPOISE

Quarter-wave or monopole antennas require an associated ground plane counterpoise for proper operation. The size and location of the ground plane relative to the antenna will affect the overall performance of the antenna in the final design. When used in conjunction with a ground plane smaller than that used to tune the antenna, the center frequency typically will shift higher in frequency and the bandwidth will decrease. The proximity of other circuit elements and packaging near the antenna will also affect the final performance.

For further discussion and guidance on the importance of the ground plane counterpoise, please refer to Linx Application Note, AN-00501: Understanding Antenna Specifications and Operation.

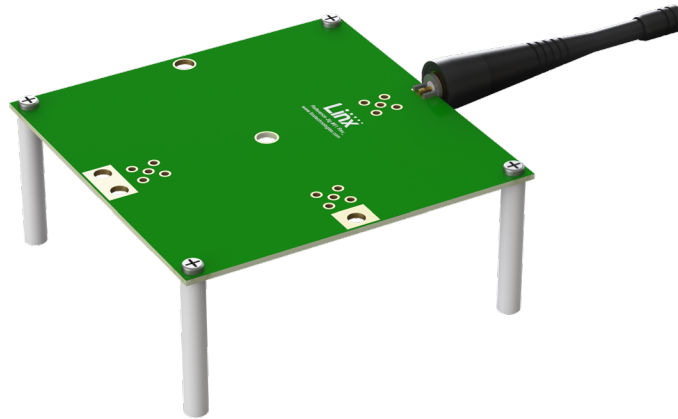
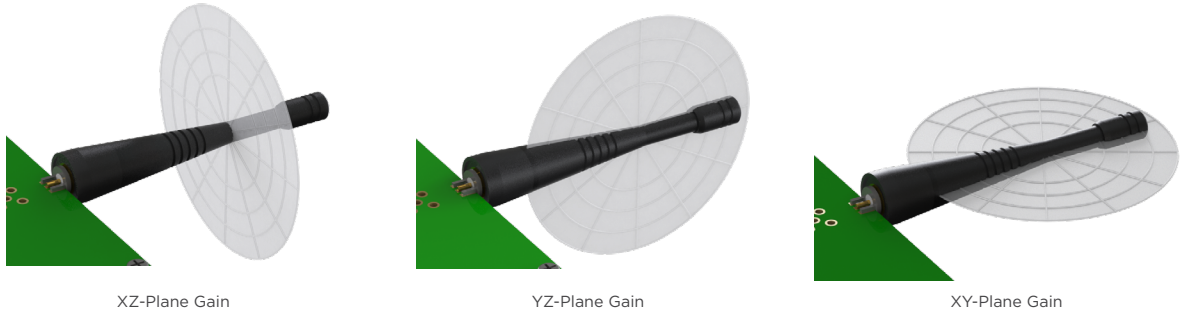

Figure 7. CW 450 MHz Antenna Shown On Edge of Evaluation Board

## RADIATION PATTERNS

Radiation patterns provide information about the directionality and 3-dimensional gain performance of the antenna by plotting gain at specific frequencies in three orthogonal planes. Antenna radiation patterns (Figure 8), are shown using polar plots covering 360 degrees. The antenna graphic above the plots provides reference to the plane of the column of plots below it. Note: when viewed with typical PDF viewing software, zooming into radiation patterns is possible to reveal fine detail.



### 450 MHz to 470 MHz (450 MHz)

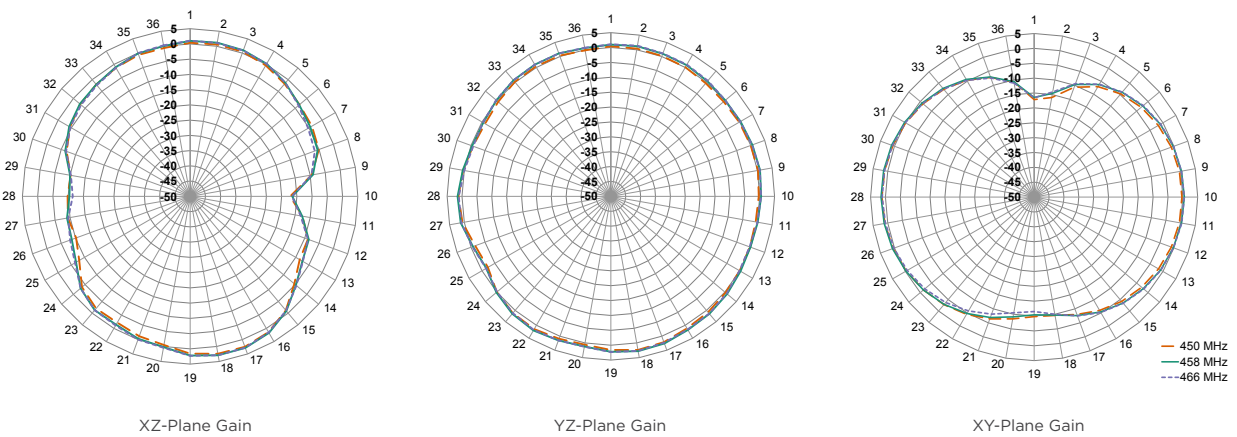

Figure 7. Radiation Patterns for ANT-433-SPS1 Antenna

---

## ANTENNA DEFINITIONS AND USEFUL FORMULAS

**VSWR** - Voltage Standing Wave Ratio. VSWR is a unitless ratio that describes the power reflected from the antenna back to the radio. A lower VSWR value indicates better antenna performance at a given frequency. VSWR is easily derived from Return Loss.

$$VSWR = \frac{10^{\left[\frac{\text{Return Loss}}{20}\right]} + 1}{10^{\left[\frac{\text{Return Loss}}{20}\right]} - 1}$$

**Return Loss** - Return loss represents the loss in power at the antenna due to reflected signals, measured in decibels. A lower return loss value indicates better antenna performance at a given frequency. Return Loss is easily derived from VSWR.

$$\text{Return Loss} = -20 \log_{10} \left[ \frac{VSWR - 1}{VSWR + 1} \right]$$

**Efficiency ( $\eta$ )** - The total power radiated from an antenna divided by the input power at the feed point of the antenna as a percentage.

**Total Radiated Efficiency** - (TRE) The total efficiency of an antenna solution comprising the radiation efficiency of the antenna and the transmitted (forward) efficiency from the transmitter.

$$TRE = \eta \cdot \left( 1 - \left( \frac{VSWR - 1}{VSWR + 1} \right)^2 \right)$$

**Gain** - The ratio of an antenna's efficiency in a given direction (G) to the power produced by a theoretical lossless (100% efficient) isotropic antenna. The gain of an antenna is almost always expressed in decibels.

$$G_{db} = 10 \log_{10}(G)$$

$$G_{dBd} = G_{dBi} - 2.51dB$$

**Peak Gain** - The highest antenna gain across all directions for a given frequency range. A directional antenna will have a very high peak gain compared to average gain.

**Average Gain** - The average gain across all directions for a given frequency range.

**Maximum Power** - The maximum signal power which may be applied to an antenna feed point, typically measured in watts (W).

**Reflected Power** - A portion of the forward power reflected back toward the amplifier due to a mismatch at the antenna port.

$$\left( \frac{VSWR - 1}{VSWR + 1} \right)^2$$

---

**decibel (dB)** - A logarithmic unit of measure of the power of an electrical signal.

**decibel isotropic (dBi)** - A comparative measure in decibels between an antenna under test and an isotropic radiator.

**decibel relative to a dipole (dBd)** - A comparative measure in decibels between an antenna under test and an ideal half-wave dipole.

**Dipole** - An ideal dipole comprises a straight electrical conductor measuring 1/2 wavelength from end to end connected at the center to a feed point for the radio.

**Isotropic Radiator** - A theoretical antenna which radiates energy equally in all directions as a perfect sphere.

**Omnidirectional** -Term describing an antenna radiation pattern that is uniform in all directions. An isotropic antenna is the theoretical perfect omnidirectional antenna. An ideal dipole antenna has a donut- shaped radiation pattern and other practical antenna implementations will have less perfect but generally omnidirectional radiation patterns which are typically plotted on three axes.

## TE TECHNICAL SUPPORT CENTER

USA:	+1 (800) 522-6752
Canada:	+1 (905) 475-6222
Mexico:	+52 (0) 55-1106-0800
Latin/S. America:	+54 (0) 11-4733-2200
Germany:	+49 (0) 6251-133-1999
UK:	+44 (0) 800-267666
France:	+33 (0) 1-3420-8686
Netherlands:	+31 (0) 73-6246-999
China:	+86 (0) 400-820-6015

## te.com

TE Connectivity, TE, TE connectivity (logo), Linx and Linx Technologies are trademarks owned or licensed by the TE Connectivity Ltd. family of companies. All other logos, products and/or company names referred to herein might be trademarks of their respective owners.

The information given herein, including drawings, illustrations and schematics which are intended for illustration purposes only, is believed to be reliable. However, TE Connectivity makes no warranties as to its accuracy or completeness and disclaims any liability in connection with its use. TE Connectivity's obligations shall only be as set forth in TE Connectivity's Standard Terms and Conditions of Sale for this product and in no case will TE Connectivity be liable for any incidental, indirect or consequential damages arising out of the sale, resale, use or misuse of the product. Users of TE Connectivity products should make their own evaluation to determine the suitability of each such product for the specific application.

TE Connectivity warrants to the original end user customer of its products that its products are free from defects in material and workmanship. Subject to conditions and limitations TE Connectivity will, at its option, either repair or replace any part of its products that prove defective because of improper workmanship or materials. This limited warranty is in force for the useful lifetime of the original end product into which the TE Connectivity product is installed. Useful lifetime of the original end product may vary but is not warranted to exceed one (1) year from the original date of the end product purchase.

©2022 TE Connectivity. All Rights Reserved.

11/22 Original