



# TAOGLAS®



# Datasheet

## Guardian 4in1 Adhesive Mount Antenna

**Part No:**  
MA963.A.B1VW.002

### Description:

Guardian 4in1 Adhesive Mount Antenna 4\*5G/4G Antenna

### Features:

- Low-Profile Adhesive Mount Panel Antenna
- 4 \* Wideband 5G/4G MIMO – 600MHz – 6GHz
- Covering Worldwide 5G/4G Bands
- Covering 5G NR Sub 6GHz Bands
- Covering CAT-M1 & NB-IoT Bands
- Includes 3G / 2G Fallback
- IP67 Rated Enclosure
- Cables: 3m TGC-200 as Standard
- Connectors: SMA(M)ST Connectors as Standard
- Dimensions: 146\*134\*20mm
- RoHS & REACH Compliant

1. Introduction	3
2. Specifications	4
3. Antenna Characteristics	7
4. Radiation Patterns	11
5. Mechanical Drawing	26
6. Packaging	27
Changelog	28

Taoglas makes no warranties based on the accuracy or completeness of the contents of this document and reserves the right to make changes to specifications and product descriptions at any time without notice. Taoglas reserves all rights to this document and the information contained herein.

Reproduction, use or disclosure to third parties without express permission is strictly prohibited.



# 1. Introduction



The Taoglas MA963 Guardian is a next-generation 4in1 combination antenna. It is the world-first panel antenna designed for IoT Gateway and Router devices with multiple wireless technologies. This antenna delivers powerful MIMO antenna technology for LTE and Sub-6GHz 5G bands covering 600MHz - 6GHz. This antenna is designed for LTE bands worldwide (including 3G & 2G fallback) for access points, terminals, and routers. CAT-M1 and NB-IoT and the recently introduced 600MHz Extended LTE Band 71 are also covered. This wide bandwidth enables designers to cover a wide range of technologies by installing a single antenna installation. It is a heavy-duty, fully IP67 waterproof external M2M antenna available in both wall and adhesive mount versions.

Typical use cases include

- IoT Gateway and Routers
- HD Video Streaming
- Transportation

4G wireless applications demand high-speed data uplink and downlink. High efficiency and high gain MIMO antennas are necessary to achieve the required signal to noise ratio and throughput required to solve these challenges. Taoglas also takes care to have high isolation among these antennas to prevent self-interference. Low loss cables used to keep efficiency high over long cable lengths.

The housing is IP67 waterproof and comes with a 3M adhesive. The antenna can be mounted internally or externally on a vehicle. The MA963 comes with 3 meter, low loss TGC-200 coaxial cables for the LTE antennas as standard. Customized cables and connector versions are also available. Contact your regional Taoglas customer support team for more information about this product, its' integration or immediate support.

## 2. Specifications

LTE Antenna											
Frequency (MHz)		5G NR Band 71	LTE700	GSM850/900	5G NR Band 74, 75, 76	DCS	PCS	UMTS1	LTE2600	5G NR Band 77, 78, 79	LTE5200/WiFi5800
		617 ~698	698 ~806	824 ~960	1427 ~1518	1710 ~1880	1850 ~1990	1920 ~2170	2490 ~2690	3300 ~5000	5150 ~5925
Efficiency (%)											
MIMO 1	3m	33.03	42.85	54.27	56.48	62.58	57.98	55.61	57.04	43.44	32.23
MIMO 2	3m	39.89	55.17	56.75	45.73	48.59	43.62	41.21	40.46	37.88	32.60
MIMO 3	3m	46.38	51.55	55.06	43.81	46.39	45.05	44.82	51.22	42.86	34.02
MIMO 4	3m	32.78	34.87	35.74	49.14	61.44	58.48	54.84	53.27	42.94	28.30
Average Gain (dB)											
MIMO 1	3m	-4.81	-3.68	-2.65	-2.48	-2.04	-2.37	-2.55	-2.44	-3.62	-4.92
MIMO 2	3m	-3.99	-2.58	-2.46	-3.40	-3.13	-3.60	-3.85	-3.93	-4.22	-4.87
MIMO 3	3m	-3.34	-2.88	-2.59	-3.58	-3.34	-3.46	-3.49	-2.91	-3.68	-4.68
MIMO 4	3m	-4.84	-4.58	-4.47	-3.09	-2.12	-2.33	-2.61	-2.74	-3.67	-5.48
Peak Gain (dBi)											
MIMO 1	3m	1.42	1.28	3.56	3.24	3.55	3.21	3.21	3.11	3.06	3.84
MIMO 2	3m	1.59	2.76	3.38	3.42	3.06	3.06	4.08	4.76	2.07	1.92
MIMO 3	3m	1.93	2.26	2.86	3.12	4.71	4.71	4.32	3.89	2.88	2.39
MIMO 4	3m	1.08	0.76	3.02	3.62	3.11	3.11	2.92	2.77	2.97	2.46
<b>Impedance</b>		50Ω									
<b>Polarization</b>		Linear									
<b>Radiation Pattern</b>		Omni									
<b>Max. input power</b>		2 W									

<b>Mechanical</b>	
<b>Height</b>	20 ±2 mm
<b>Planner Dimension</b>	146*134 mm
<b>Casing</b>	ASA
<b>Cable</b>	TCG-200 3000 mm
<b>Connector</b>	SMA(M)
<b>Weight</b>	730g
<b>Environmental</b>	
<b>Protection</b>	IP67
<b>Temperature Range</b>	-40°C to 85°C
<b>Humidity</b>	Non-condensing 65°C 95% RH

5G/4G Bands			
Band Number	5G NR / FR1 / LTE / LTE-Advanced / WCDMA / HSPA / HSPA+ / TD-SCDMA		
	Uplink	Downlink	Covered
1	UL: 1920 to 1980	DL: 2110 to 2170	✓
2	UL: 1850 to 1910	DL: 1930 to 1990	✓
3	UL: 1710 to 1785	DL: 1805 to 1880	✓
4	UL: 1710 to 1755	DL: 2110 to 2155	✓
5	UL: 824 to 849	DL: 869 to 894	✓
7	UL: 2500 to 2570	DL: 2620 to 2690	✓
8	UL: 880 to 915	DL: 925 to 960	✓
9	UL: 1749.9 to 1784.9	DL: 1844.9 to 1879.9	✓
11	UL: 1427.9 to 1447.9	DL: 1475.9 to 1495.9	✓
12	UL: 699 to 716	DL: 729 to 746	✓
13	UL: 777 to 787	DL: 746 to 756	✓
14	UL: 788 to 798	DL: 758 to 768	✓
17	UL: 704 to 716	DL: 734 to 746	✓
18	UL: 815 to 830	DL: 860 to 875	✓
19	UL: 830 to 845	DL: 875 to 890	✓
20	UL: 832 to 862	DL: 791 to 821	✓
21	UL: 1447.9 to 1462.9	DL: 1495.9 to 1510.9	✓
22	UL: 3410 to 3490	DL: 3510 to 3590	✓
23	UL: 2000 to 2020	DL: 2180 to 2200	✓
24	UL: 1625.5 to 1660.5	DL: 1525 to 1559	✓
25	UL: 1850 to 1915	DL: 1930 to 1995	✓
26	UL: 814 to 849	DL: 859 to 894	✓
27	UL: 807 to 824	DL: 852 to 869	✓
28	UL: 703 to 748	DL: 758 to 803	✓
29	UL: -	DL: 717 to 728	✓
30	UL: 2305 to 2315	DL: 2350 to 2360	✓
31	UL: 452.5 to 457.5	DL: 462.5 to 467.5	✗
32	UL: -	DL: 1452 - 1496	✓
35		1850 to 1910	✓
38		2570 to 2620	✓
39		1880 to 1920	✓
40		2300 to 2400	✓
41		2496 to 2690	✓
42		3400 to 3600	✓
43		3600 to 3800	✓
48		3550 to 3700	✓
66	UL: 1710-1780	DL: 2110-2200	✓
71		617 to 698	✓
74/75/76		1427 to 1518	✓
78		3300 to 3800	✓
79		4400 to 5000	✓
126		410 to 430	✗

\*Covered bands represent greater than 20% efficiency

### 3. Antenna Characteristics

#### 3.1 Test Setup – Free Space

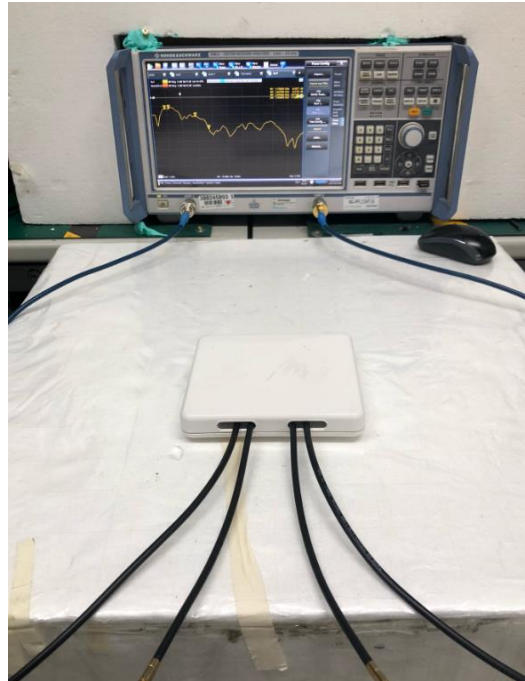

### 3.2 Return Loss

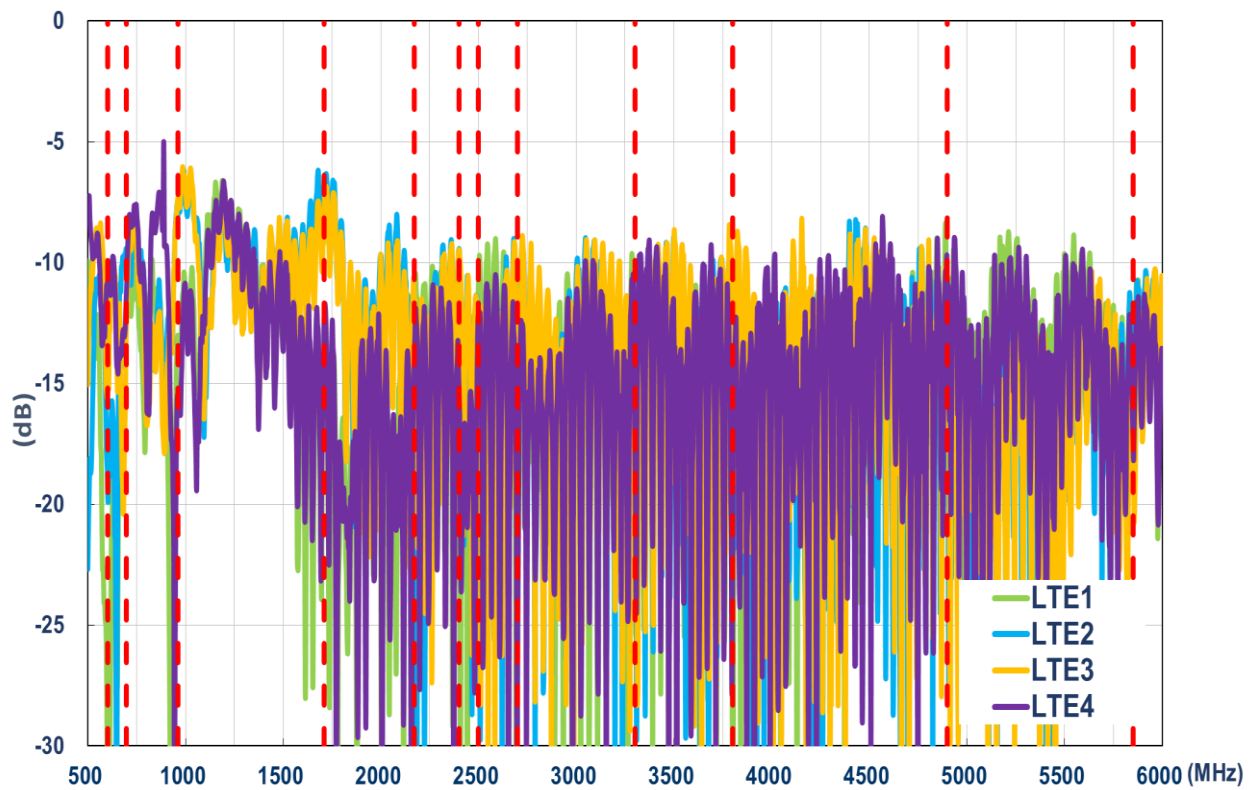

### 3.3 Isolation

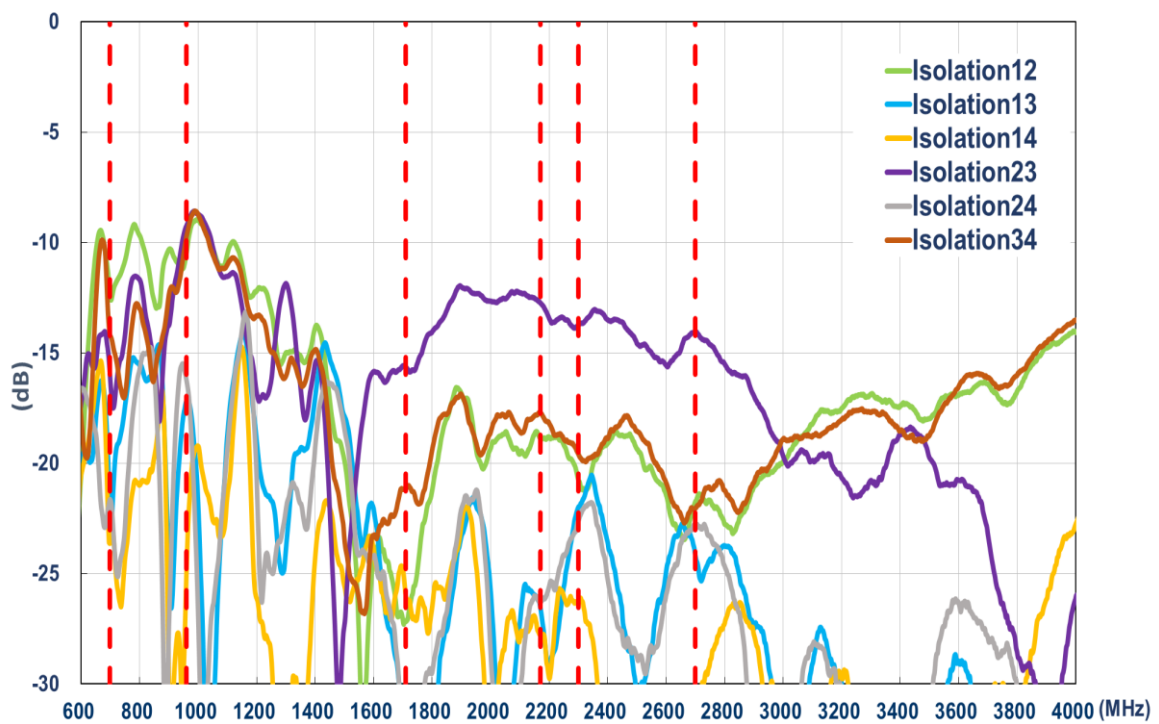



### 3.4 Efficiency

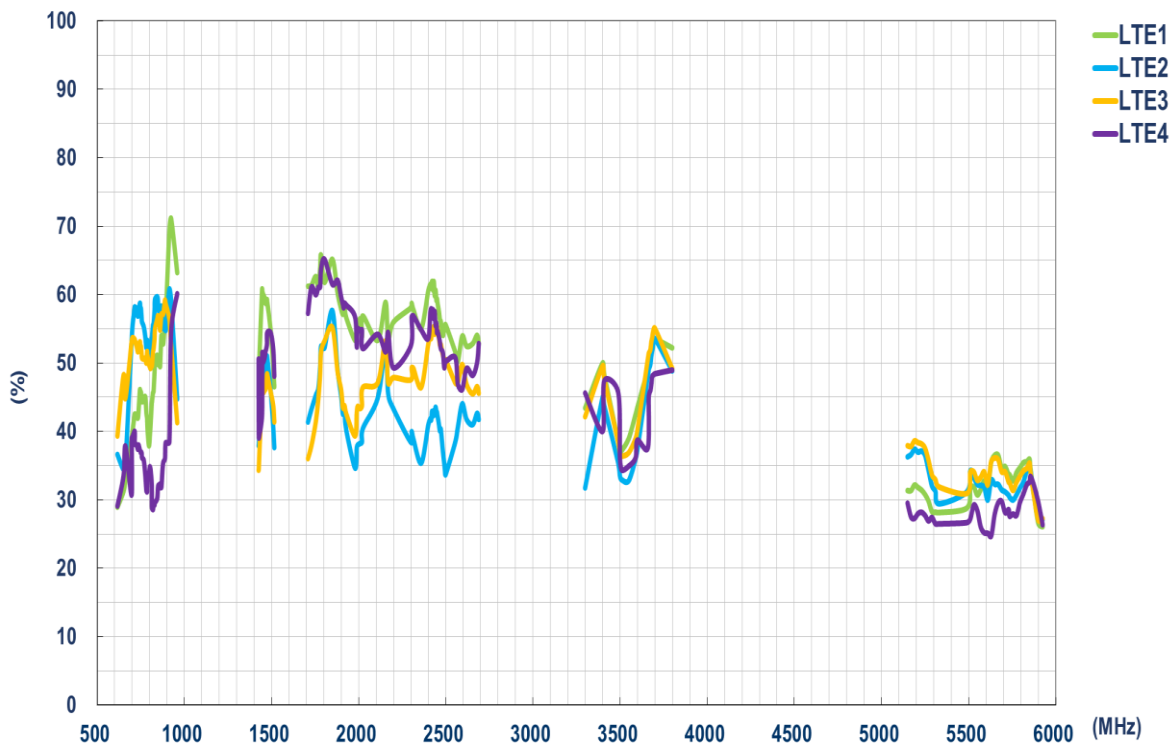

### 3.5 Average gain

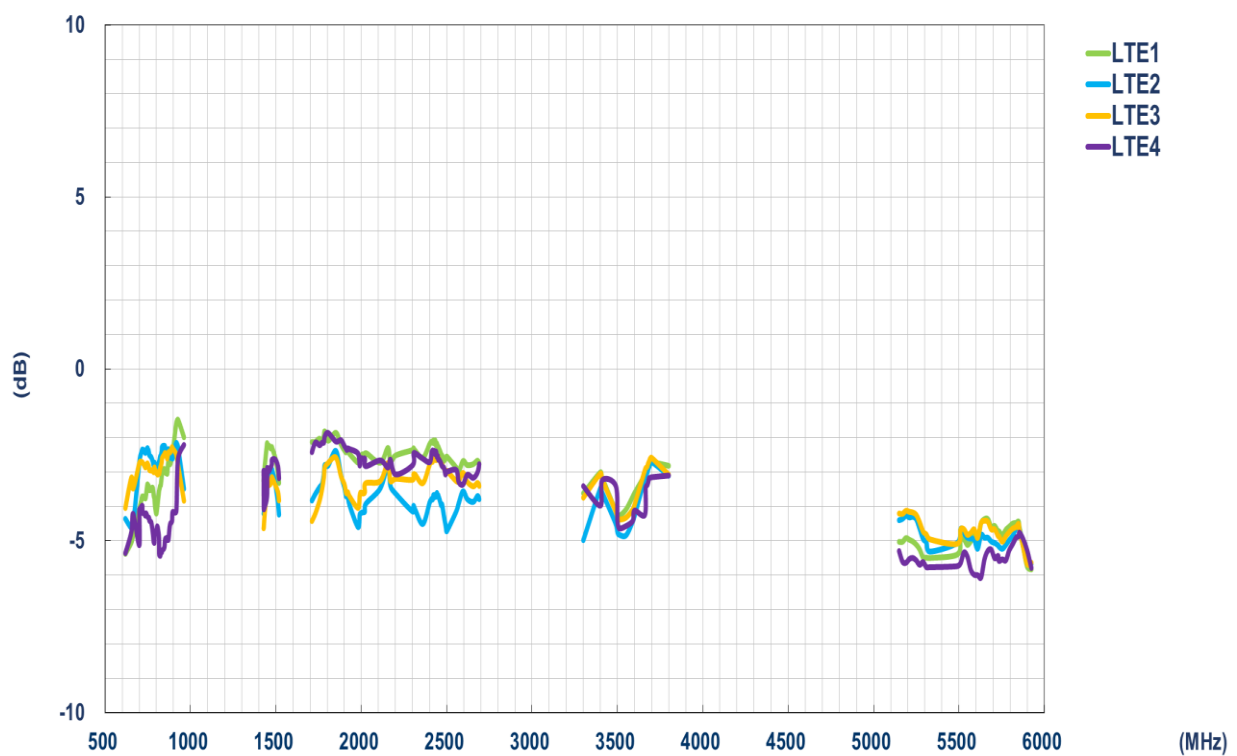

### 3.6 Peak gain

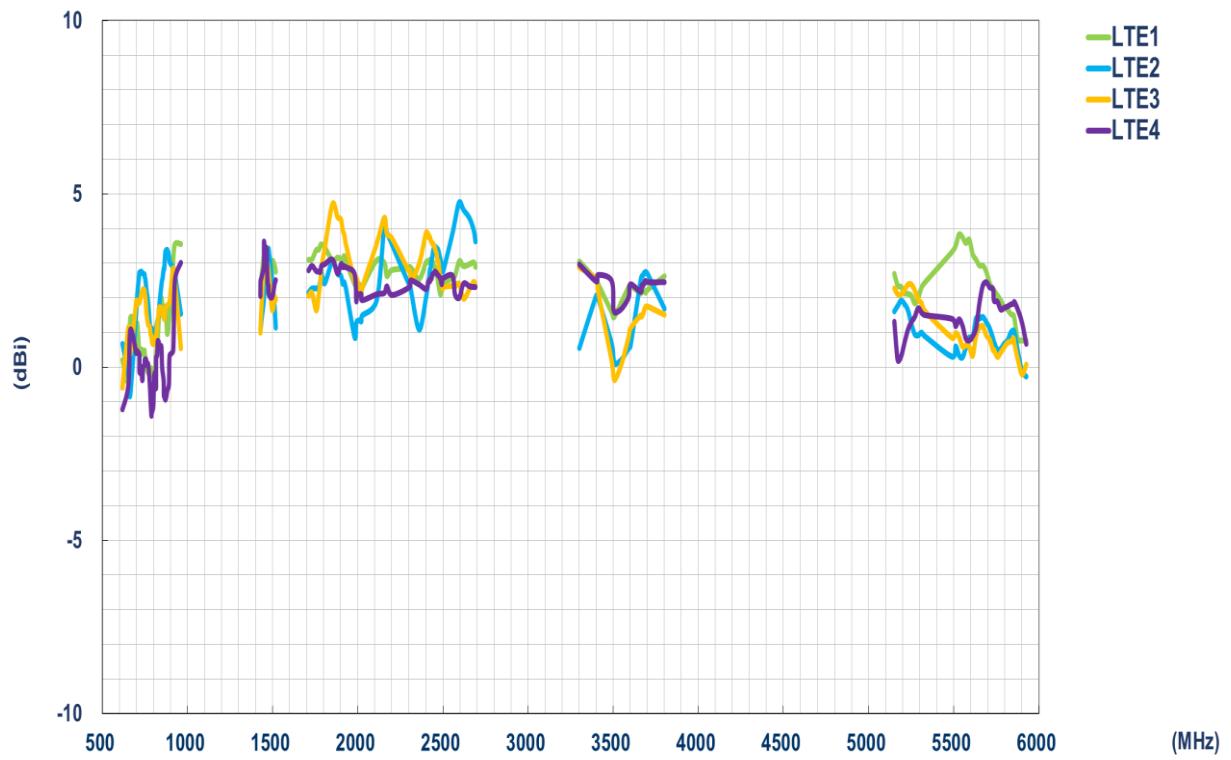

## 4. Radiation Patterns

### 4.1 Test Setup – Free Space

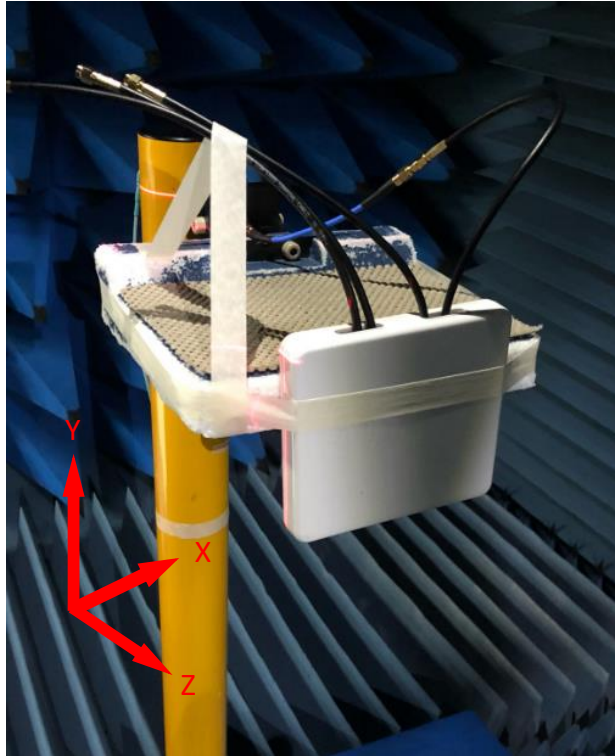

## 4.2 2D Radiation Patterns

### 4.2.1 5G/4G MIMO1

#### XY Plane

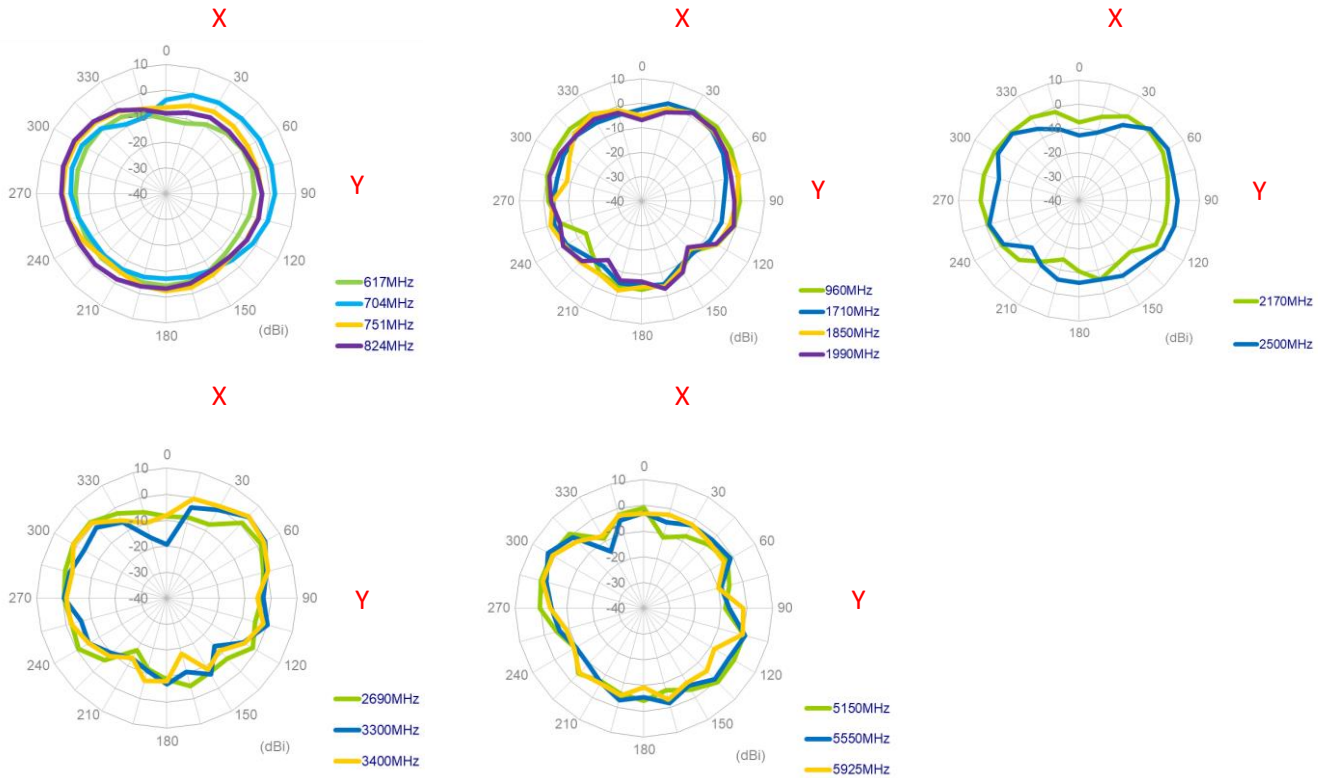

#### XZ Plane

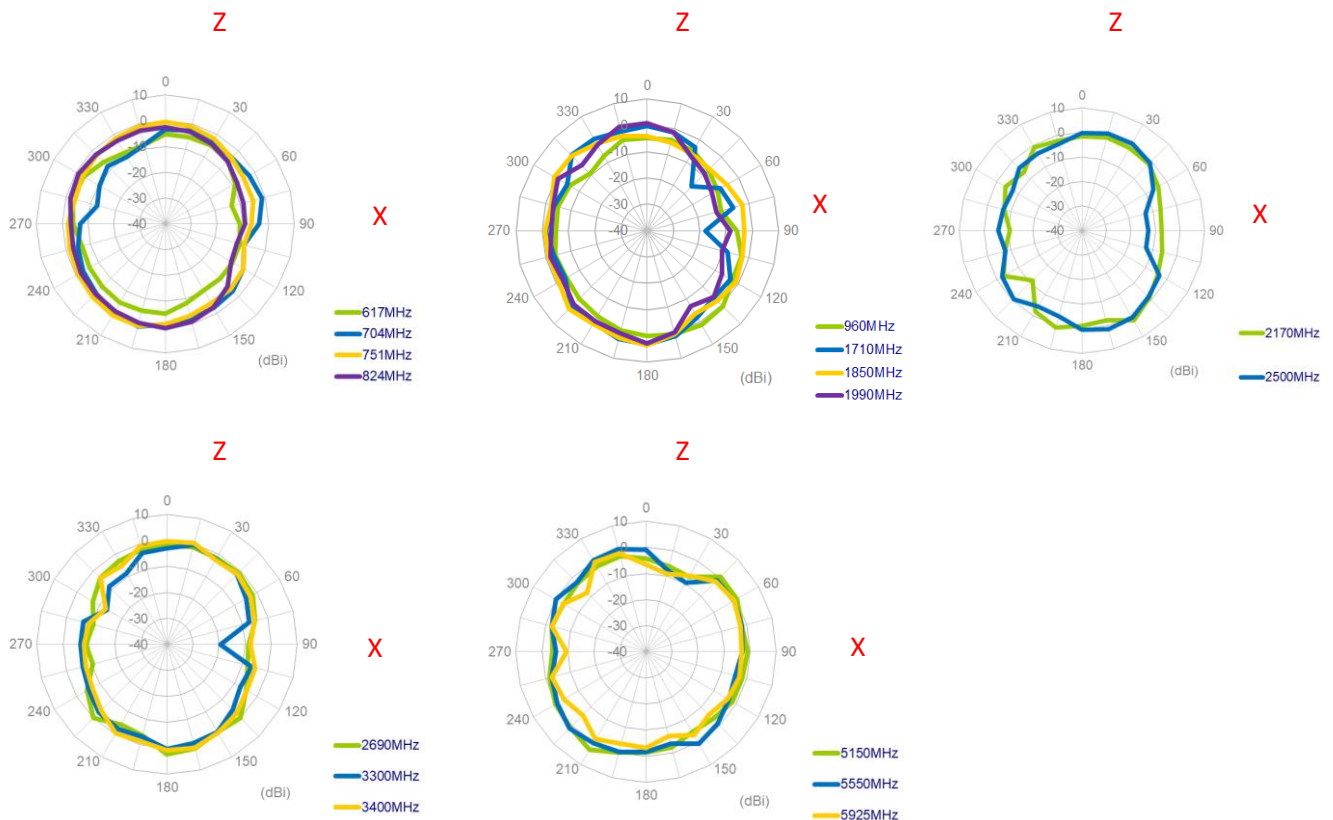

## YZ Plane

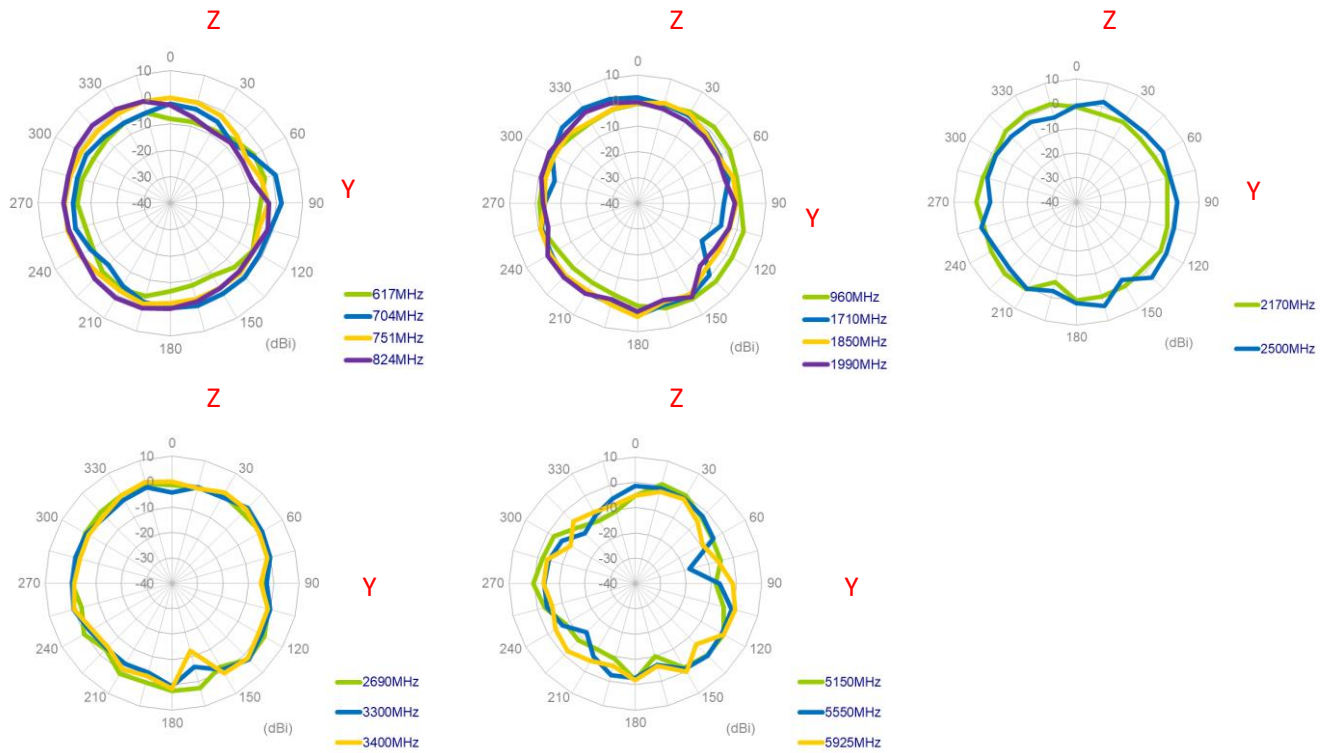

### 4.2.2 5G/4G MIMO2

## XY Plane

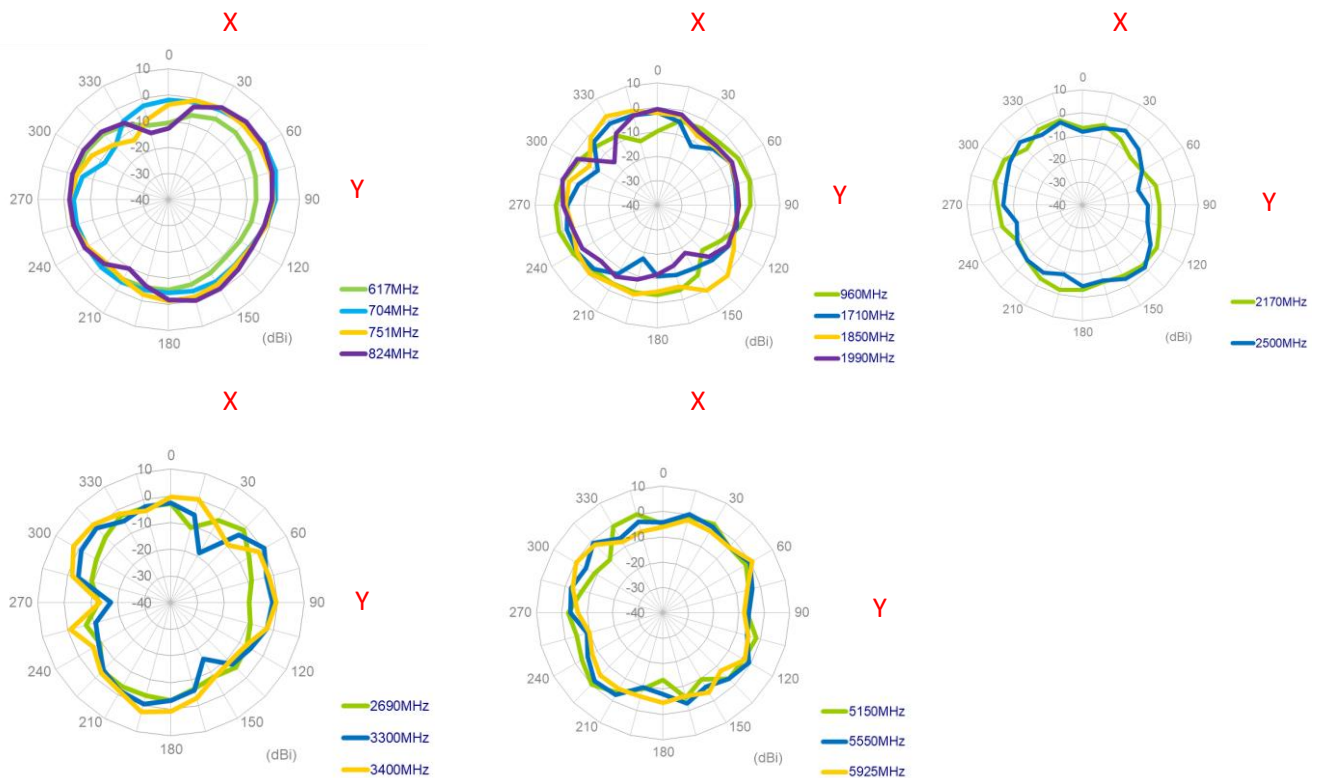

## XZ Plane

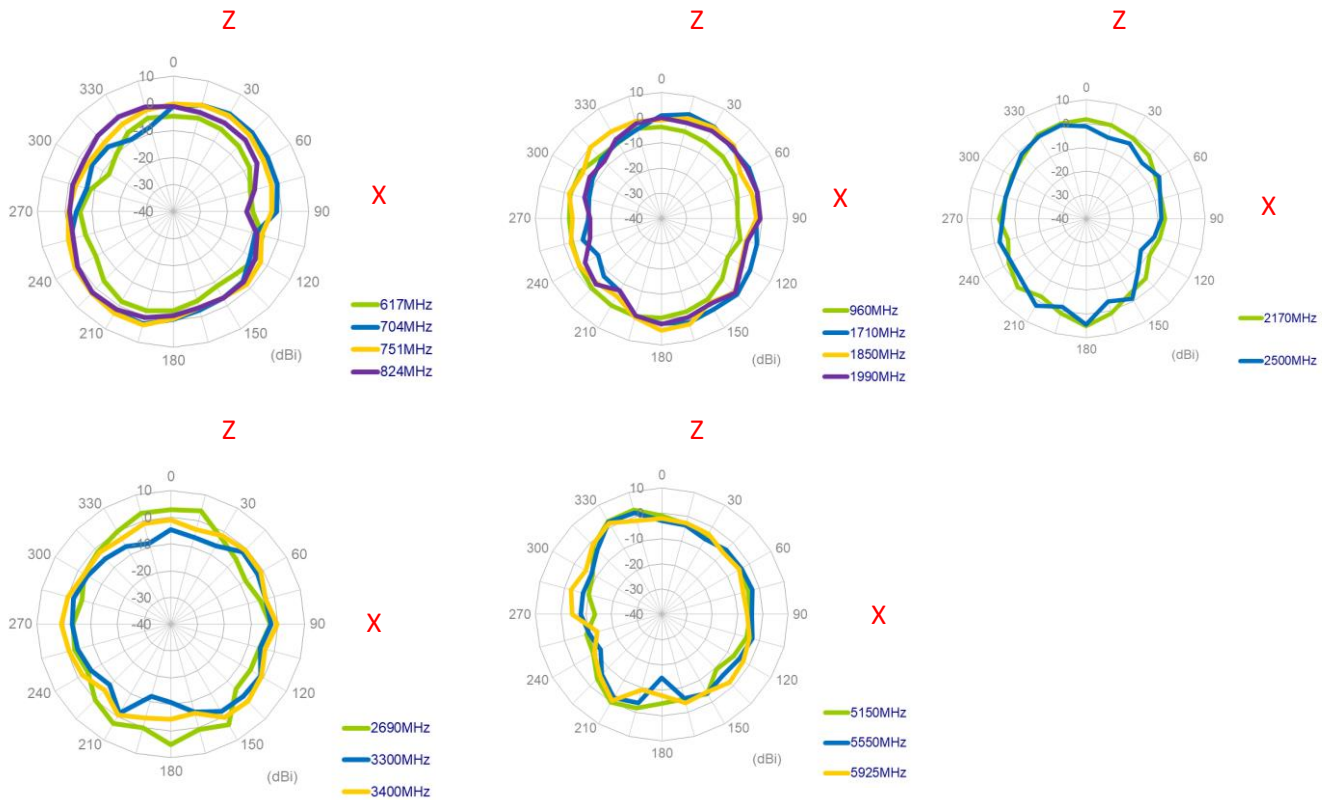

## YZ Plane

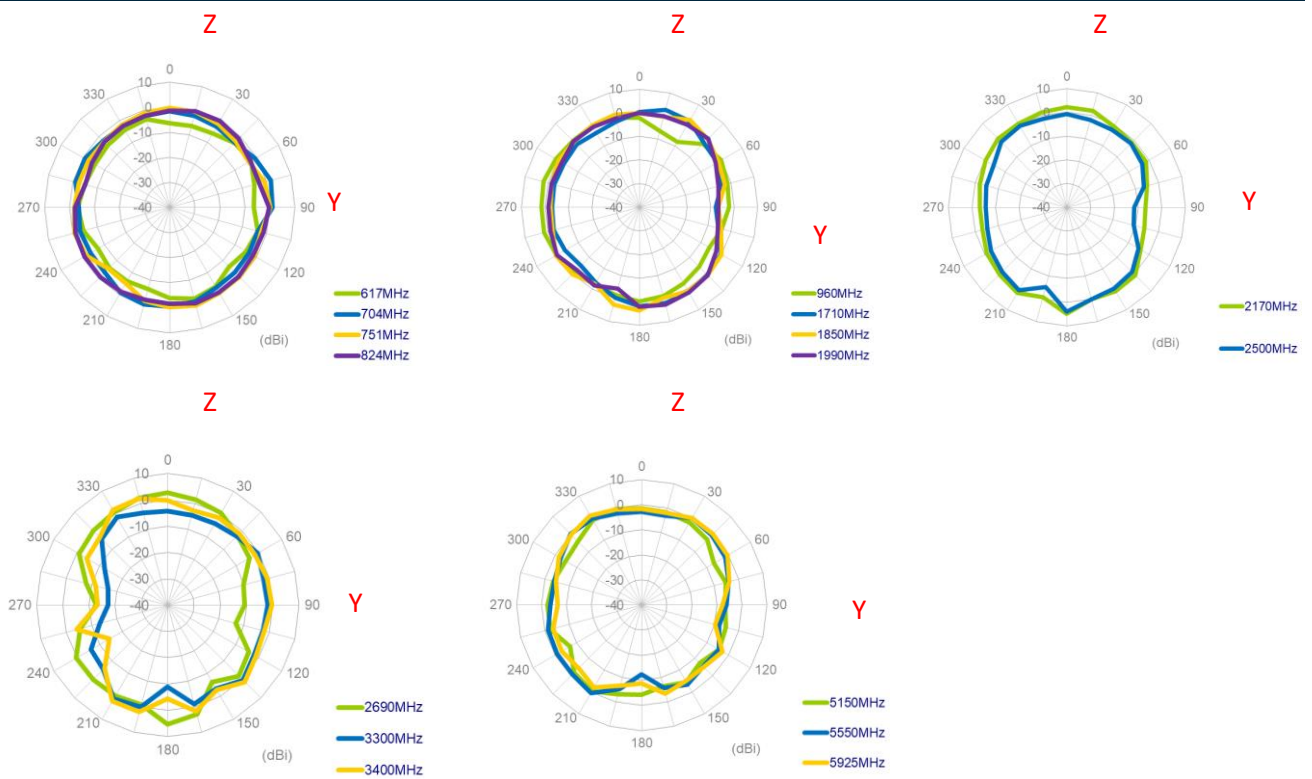

### 4.2.3 5G/4G MIMO3

#### XY Plane

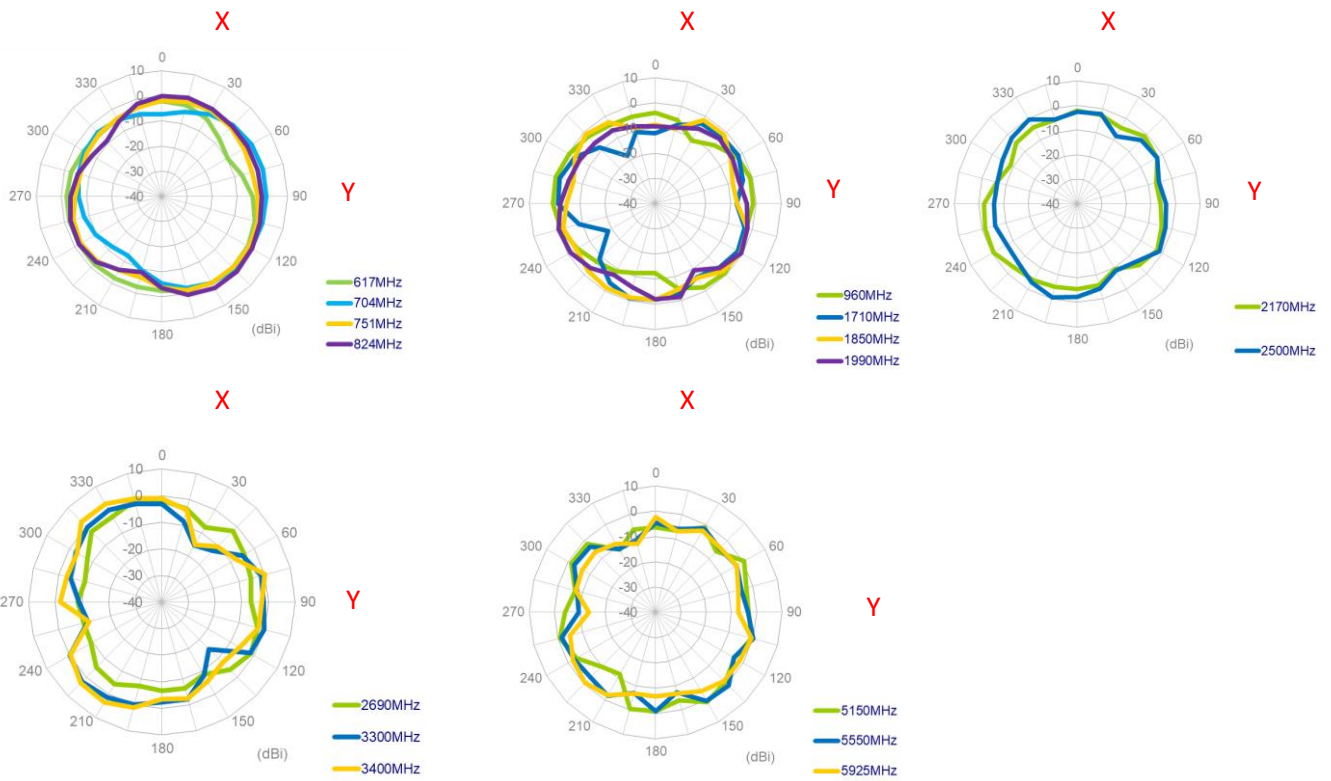

#### XZ Plane

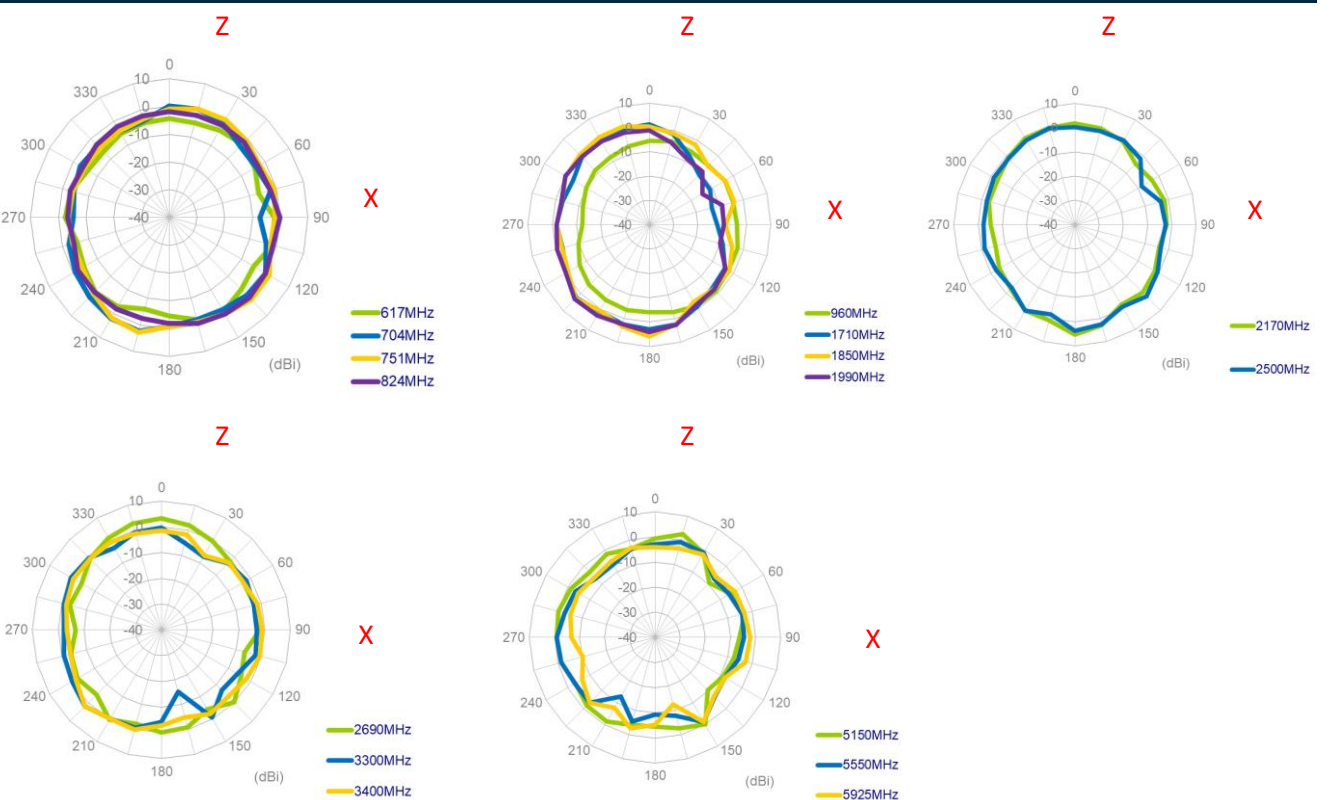

## YZ Plane

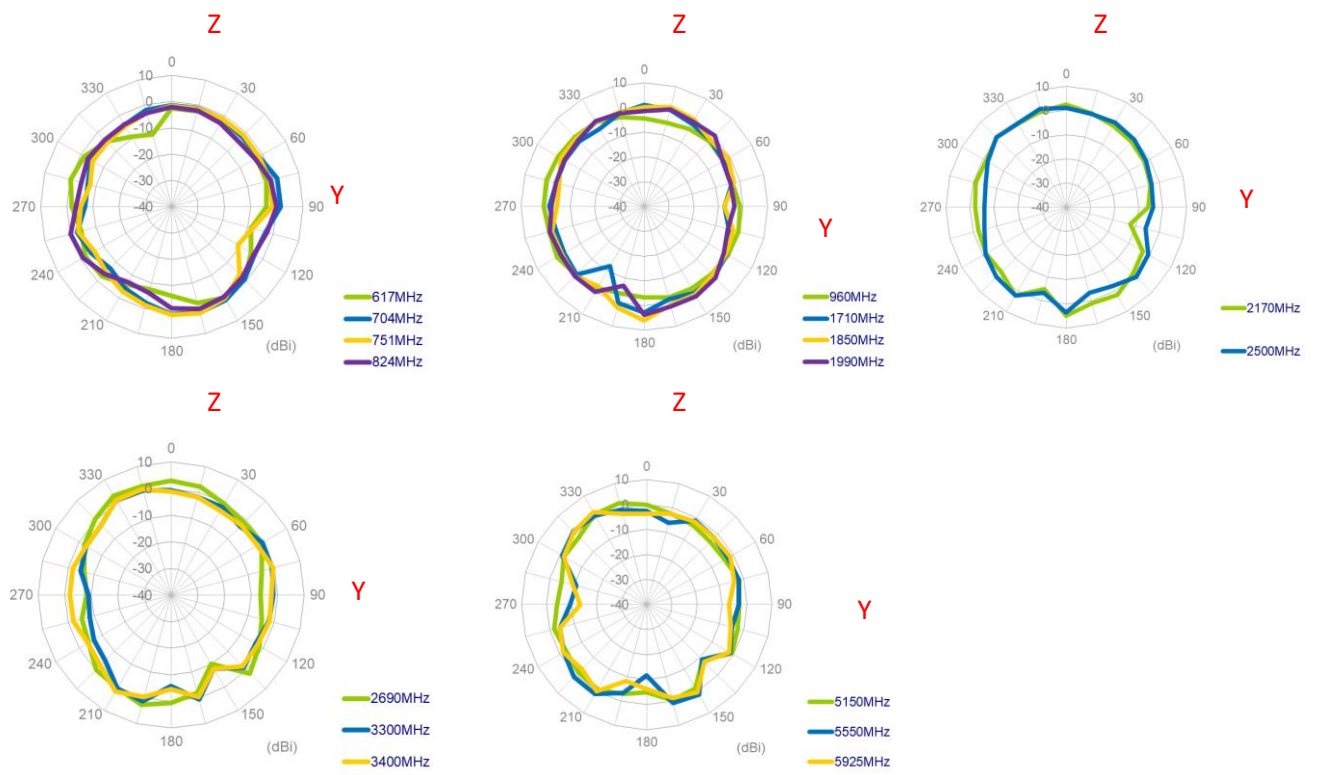

### 4.2.4 5G/4G MIMO4

## XY Plane

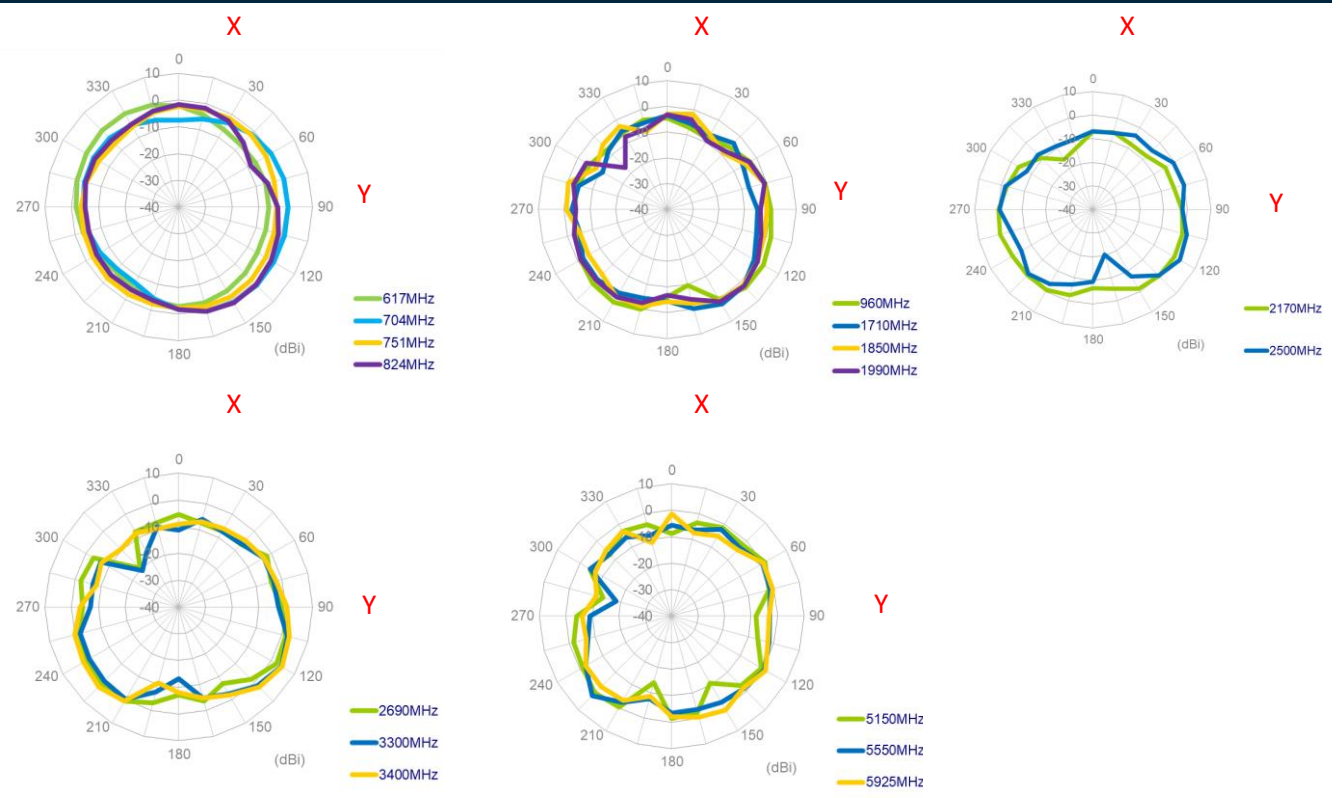



## XZ Plane

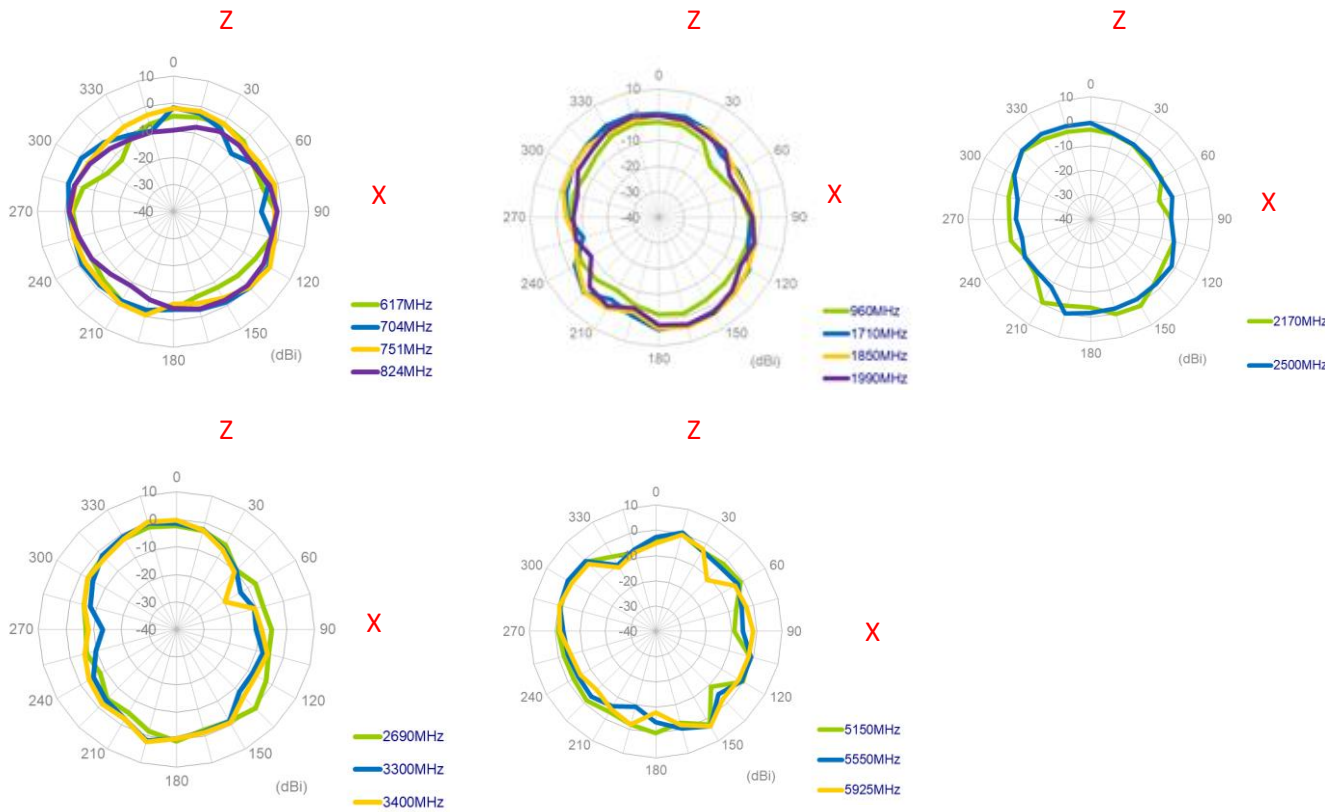

## YZ Plane

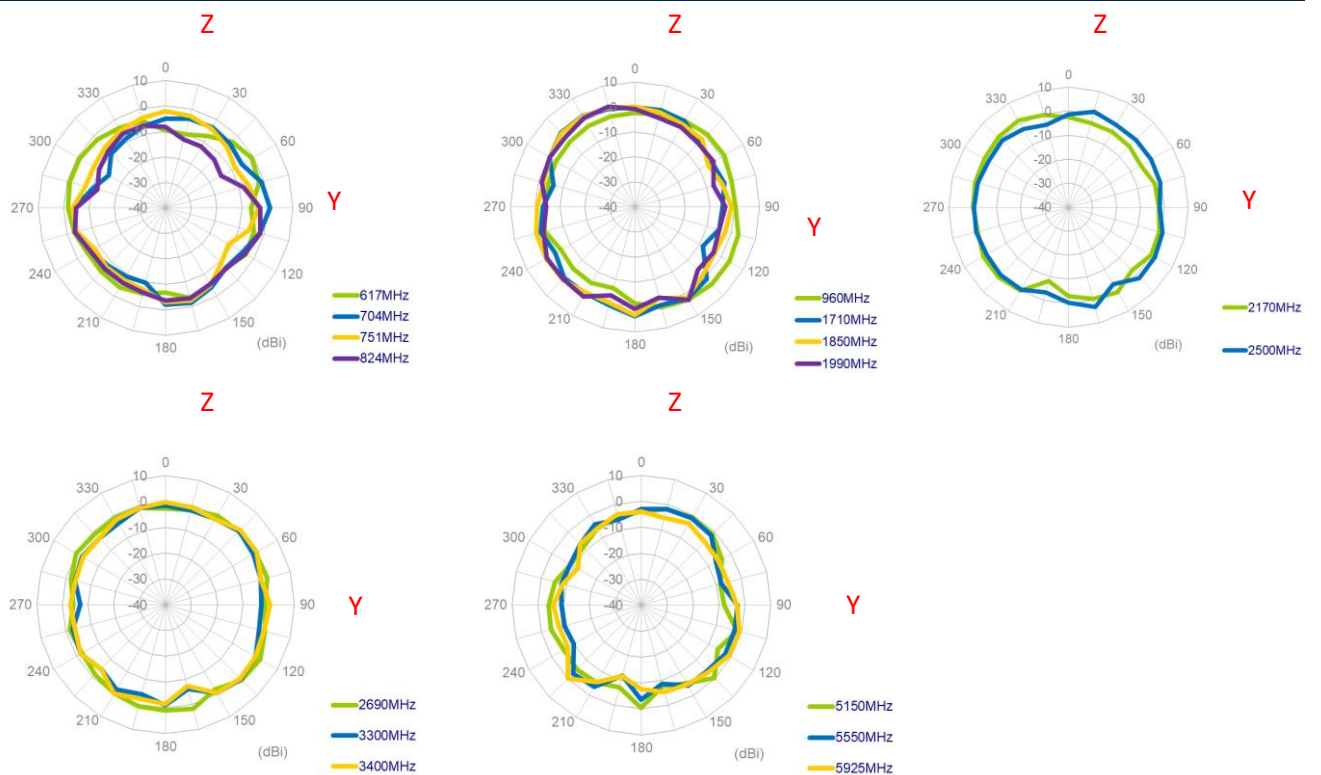

## 4.3 3D Radiation Pattern

### 4.3.1 5G/4G MIMO1

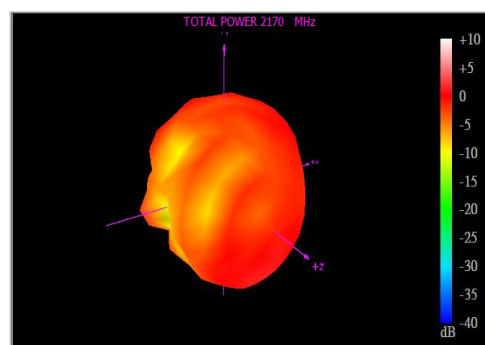
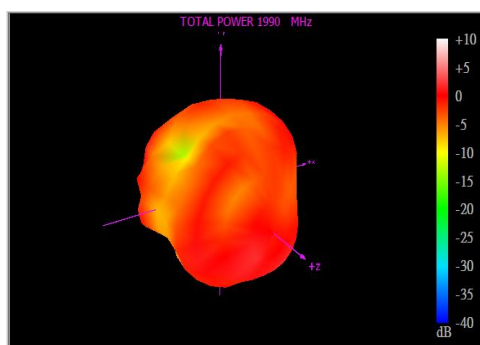
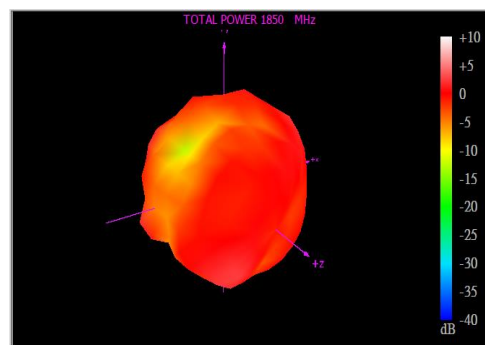
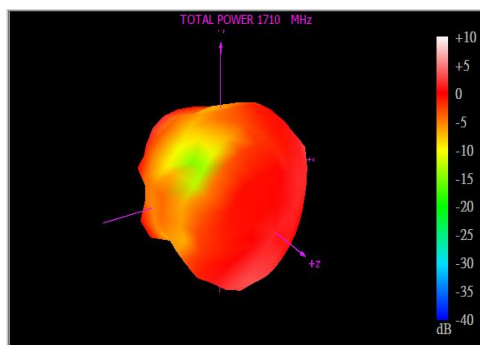
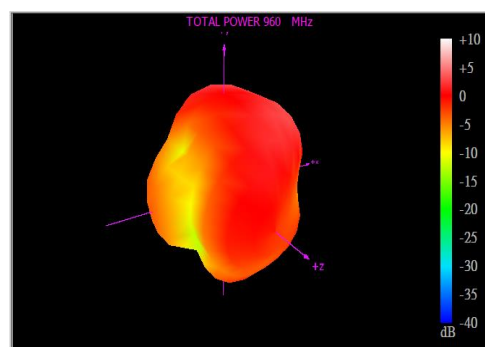
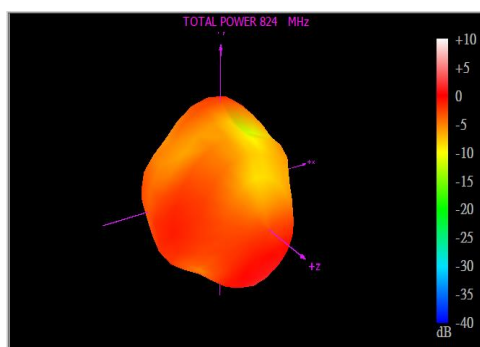
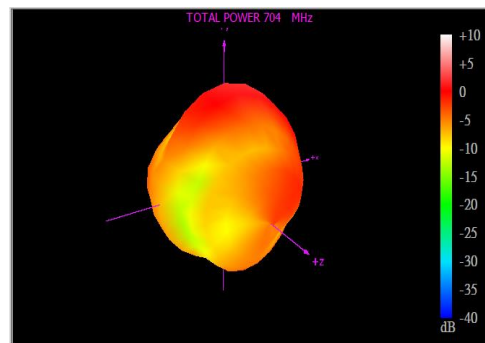
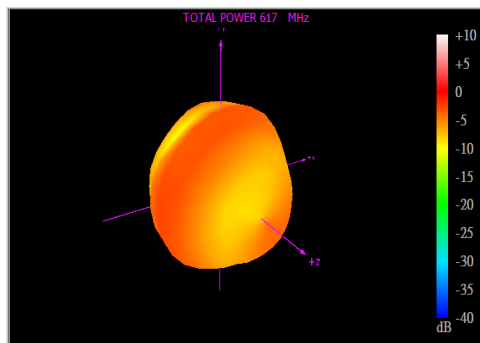

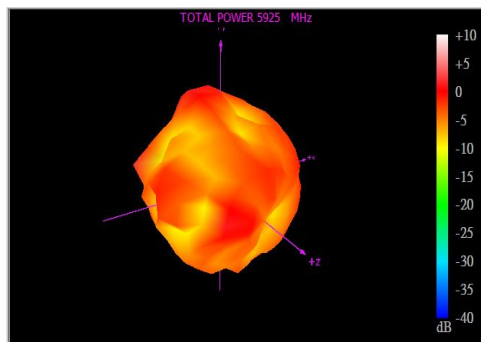
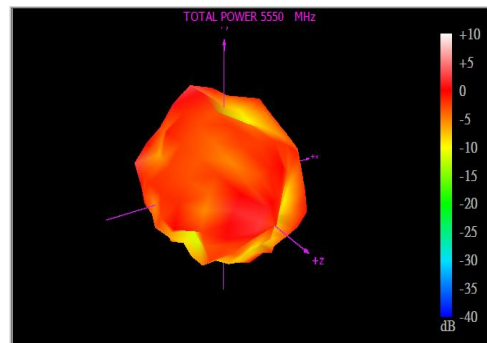
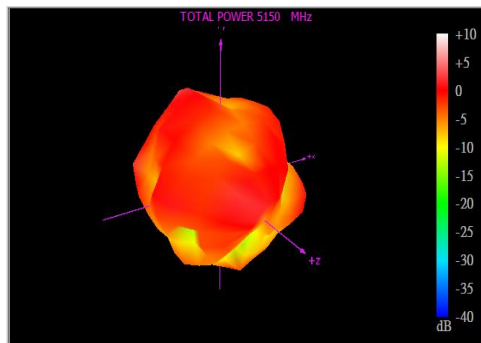
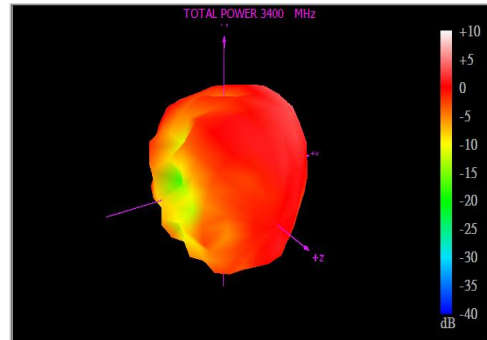
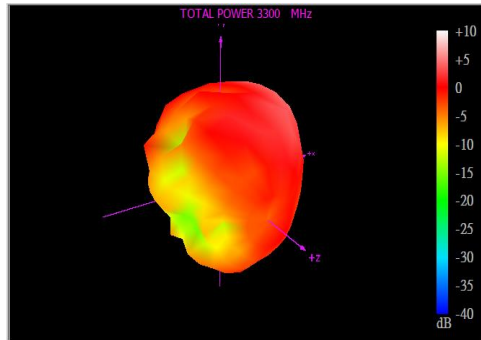
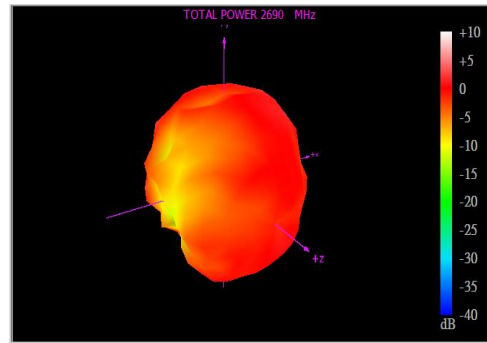
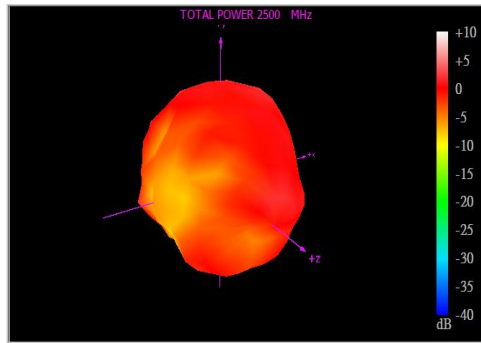

### 4.3.2 5G/4G MIMO2

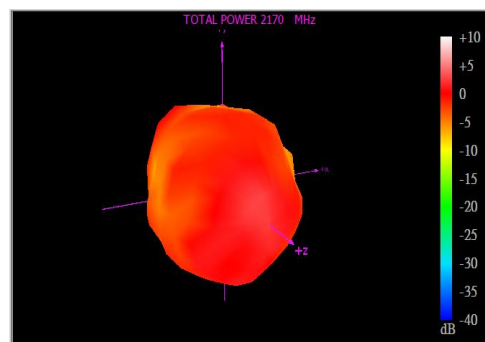
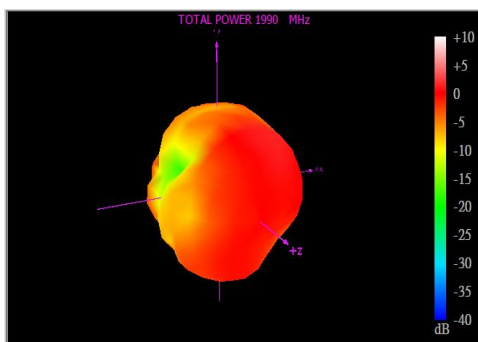
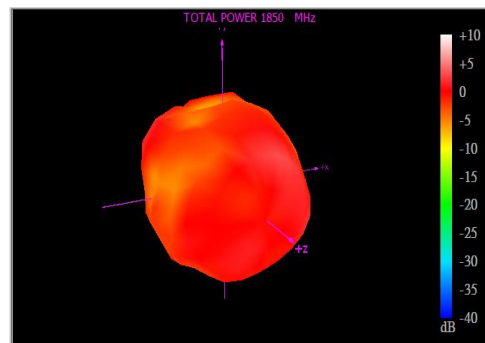
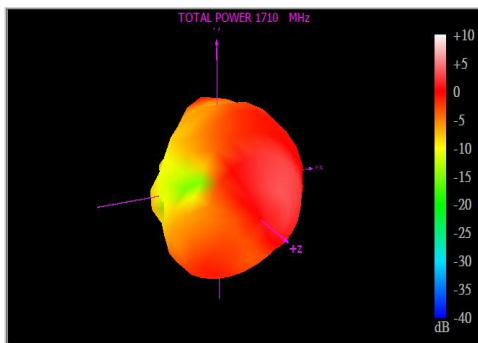
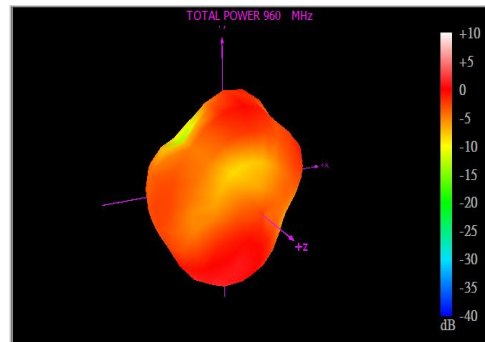
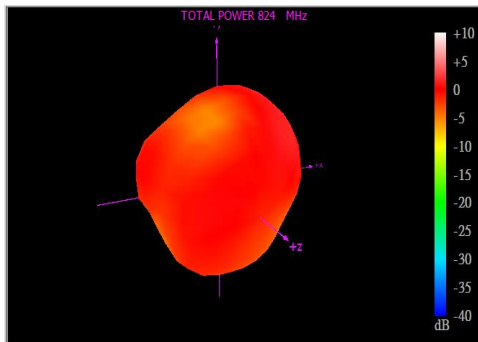
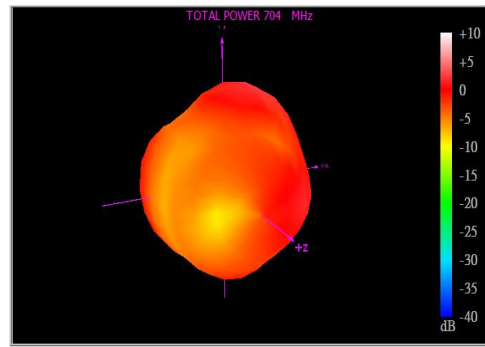
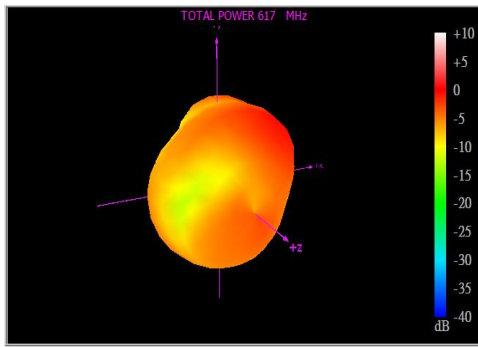

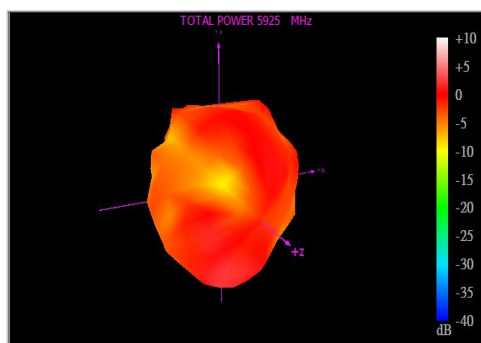
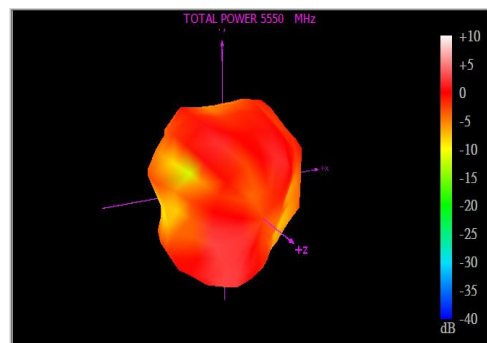
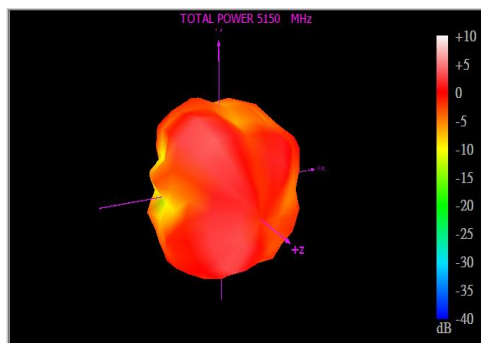
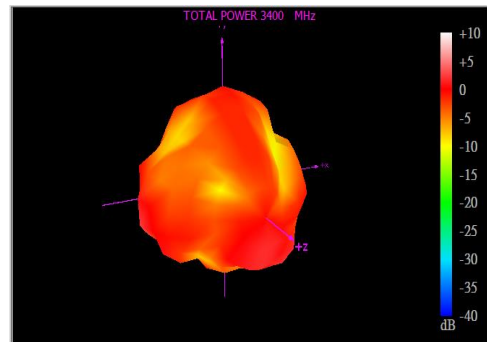
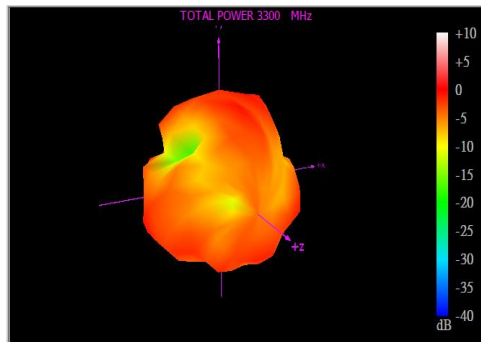
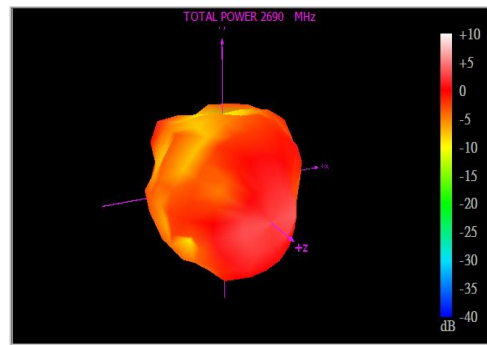
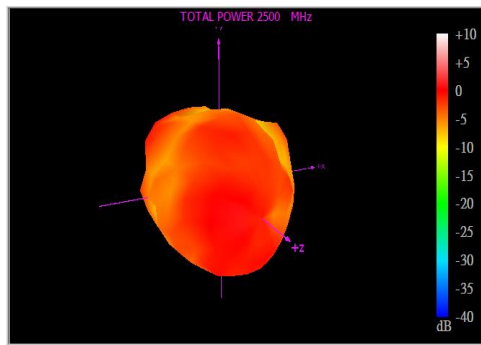

### 4.3.3 5G/4G MIMO3

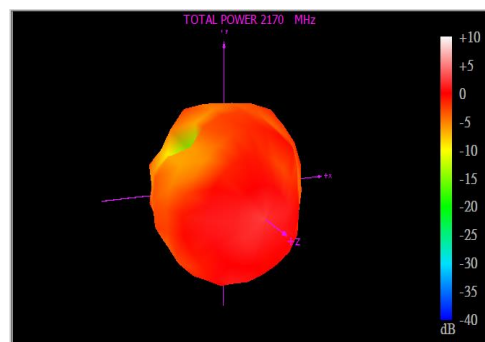
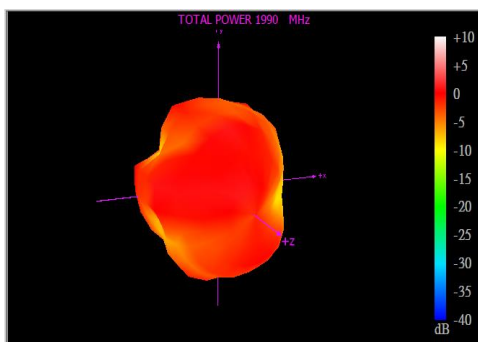
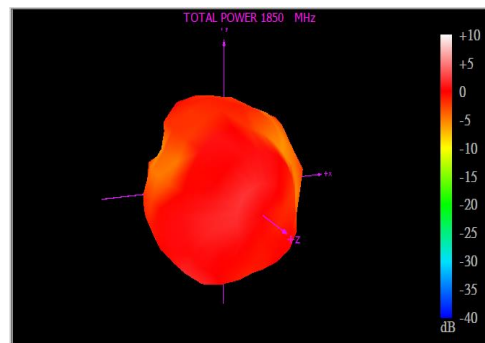
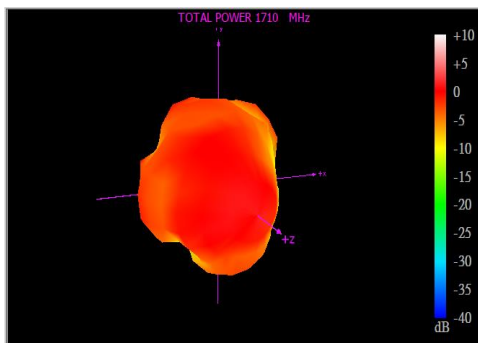
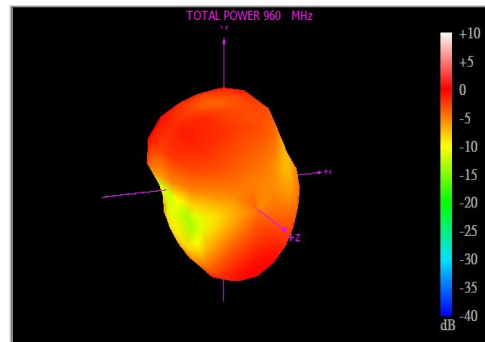
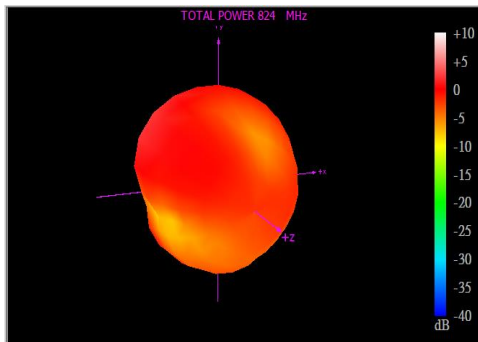
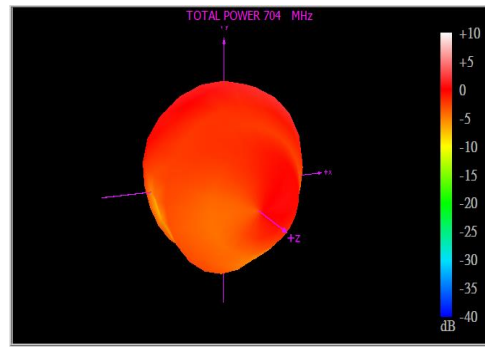
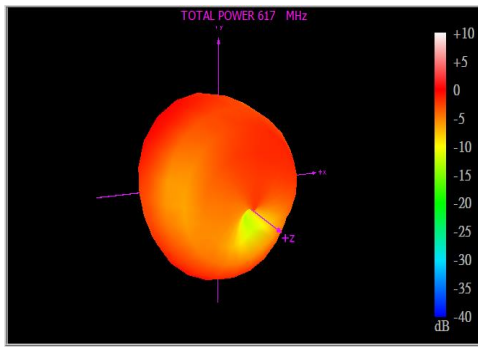

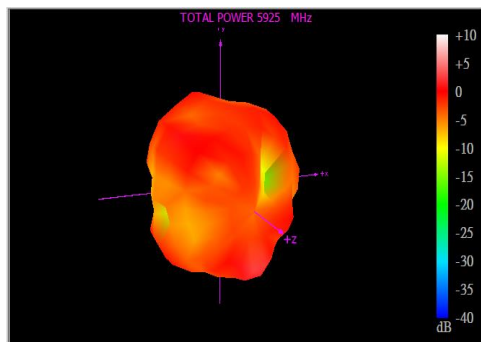
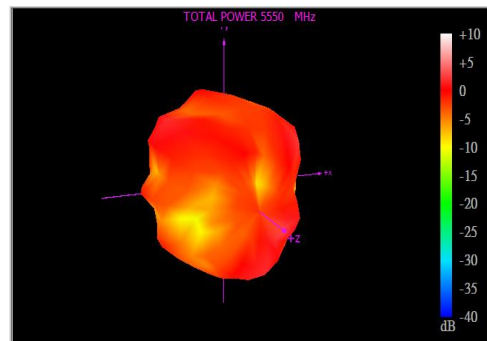
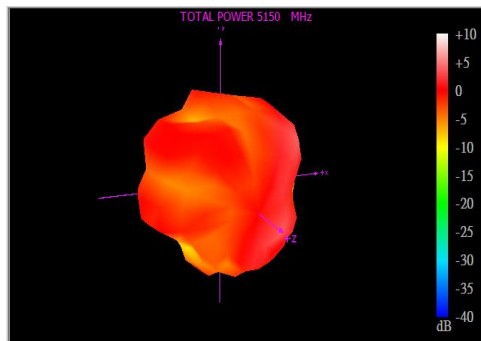
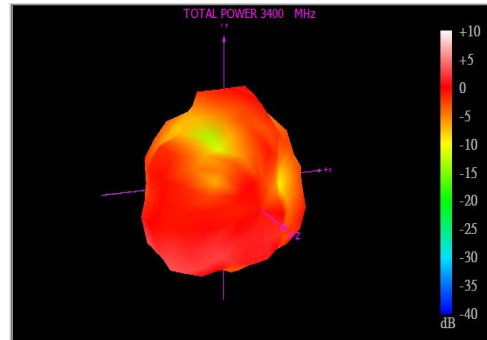
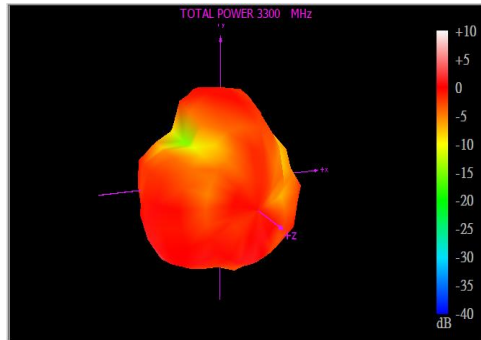
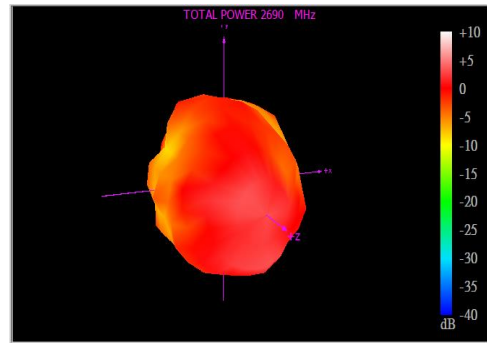
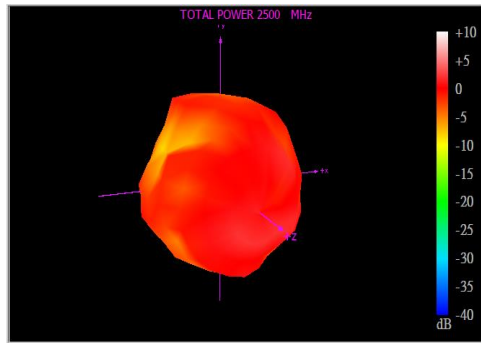

### 4.3.4 5G/4G MIMO4

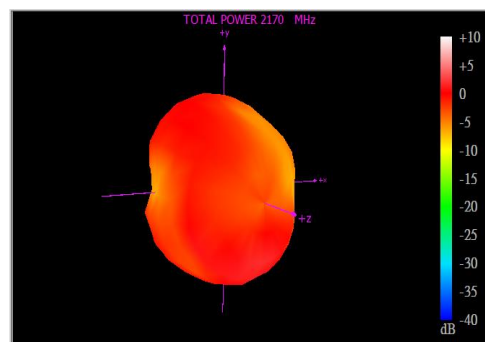
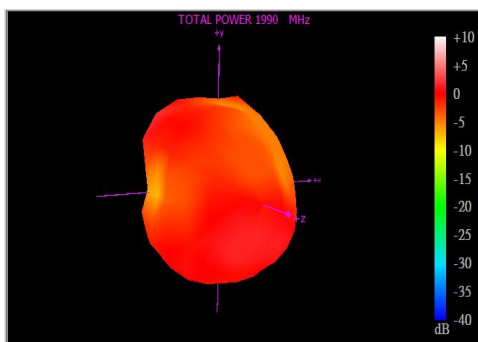
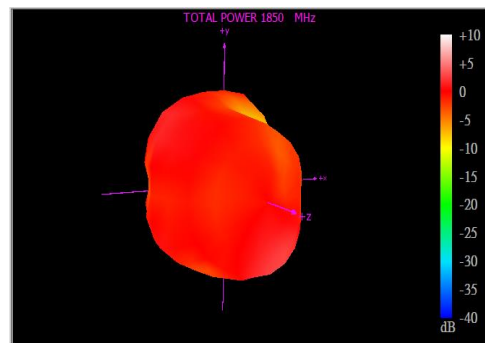
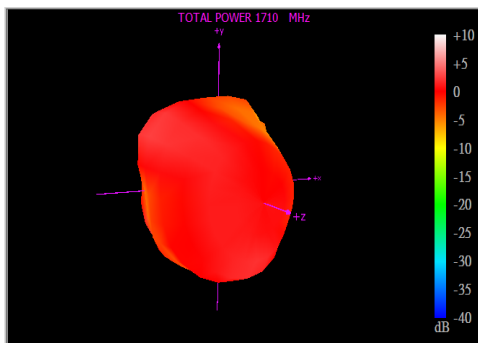
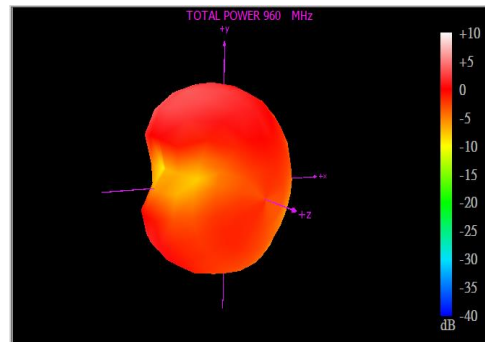
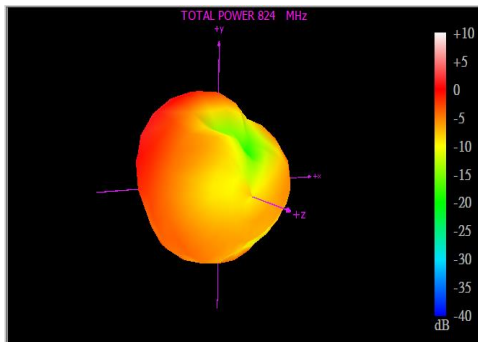
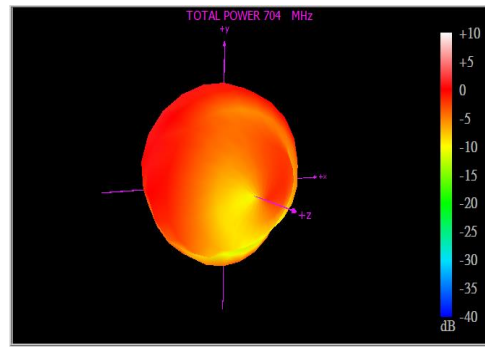
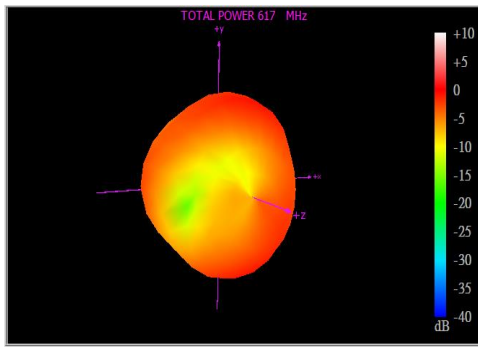



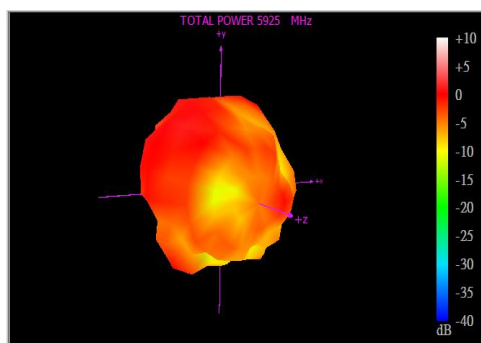
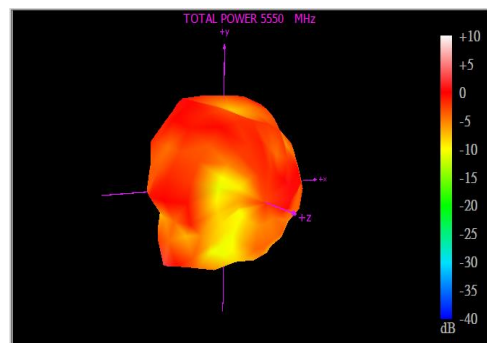
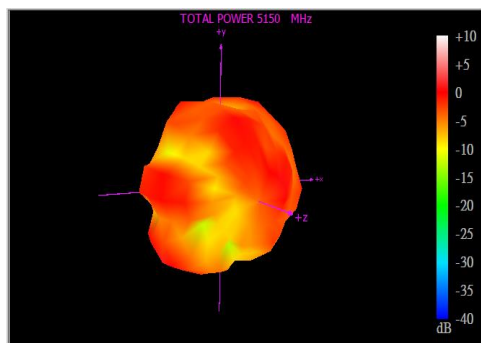
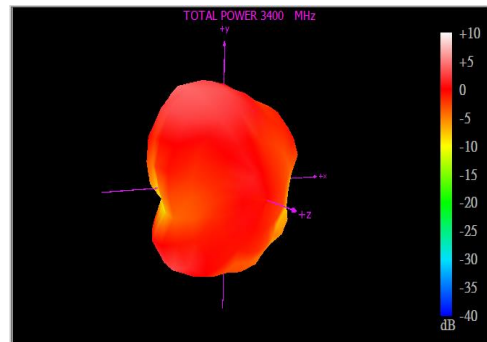
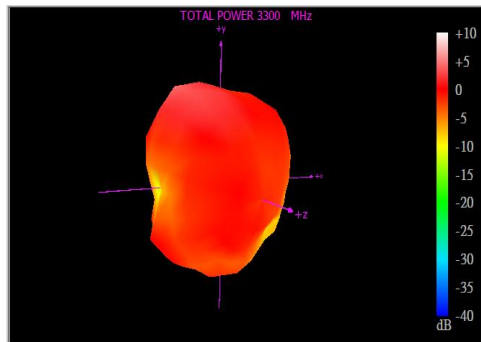
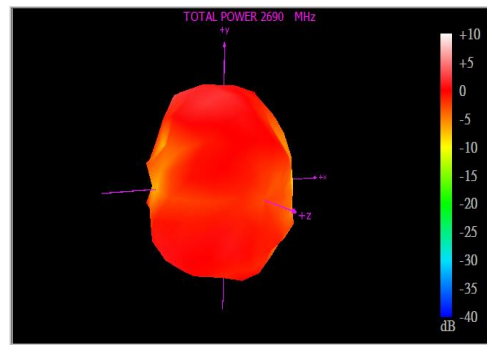
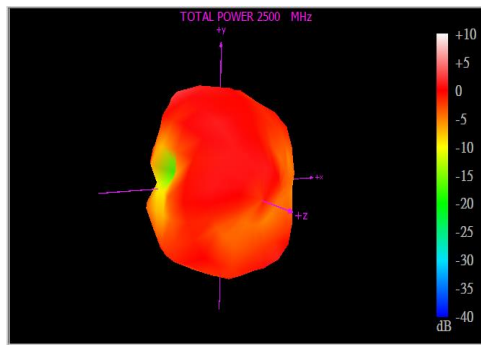

# 5. Mechanical Drawing (Units: mm)

6	5	4	3	2	1				
ISO NO: EDW-19-8-0280		<Release>		REV	ZONE	DESCRIPTION	ENG	APPROVED	ISSUED DATE
		ALL		MA9XX series products, mold transfer, Change supplier/Connector/Cable/BOM/Title. <EC-21-08-004>	Ruby	Aaron	2021/03/30		
		ALL		Remove the clear label	Ruby	Aaron	2021/04/07		

**Front View**

**Bottom View**

**Side View**

**Double sided Adhesive(Black Foam)**

**Back View**

Name	P/N	Material	Finish	QTY
1 Top Housing	000116B000000A	ASA	Black	1
2 Bottom Housing	000116B010000A	ASA	Black	1
3 Rubber-2 Holes	000715H010000A	Silicone Rubber	Black	2
5 Heat Shrink Tube (LTE-1)	001317C020000A	PE	Red Tube/White Text	1
6 Heat Shrink Tube (LTE-2)	001317C030000A	PE	Red Tube/White Text	1
7 Heat Shrink Tube (LTE-3)	001317J000000A	PE	Red Tube/White Text	1
8 Heat Shrink Tube (LTE-4)	001317J010000A	PE	Red Tube/White Text	1
9 Double Sided Adhesive(Black Foam)	001019C010000A	GRK5384W8K 35H	White Liner	1
10 Empty Label	001015G000000A	PEPA	White	1
11 Barcode Label	001015G010000A	PET	White	1
12 TGC200 Coaxial Cable	306718E000000A	PE	Black	4
13 SMA(M)ST	200220C00001GA	Brass	Au Plated	4

NOTES:

- All material must be RoHS compliant.
- The connector orientation has a fixed position to the antenna as per drawing.
- Part No.: MA963.W.A.B30PP111.J30PP111.V30PP111.W30PP111
- Double Sided Adhesive Area :

UNLESS OTHERWISE SPECIFIED TOLERANCES ON:		DATE: 2019/10/09	MAT'L:
.X± 0.2		UNIT: mm	FINISH:
XX± 0.5 .XX± 0.1		THIRD ANGLE PROJECTION	SCALE: 1/2.5
X± 0.3 .XXX± 0.05		APPROVED BY: CUSTOMERS SIGNATURE / DATE	
APPROVED BY: Aaron	CHECKED BY: Aaron	DRAWN BY: Rachel	

TW Design Centre  
This drawing and its inherent design concepts are property of Taoglas. Not to be copied or given to third parties without the written consent of Taoglas.

TITLE : 4in1 Adhesive 3000mm:  
LTE 600-6000MHz(1,2,3,4) TGC-200 SMA(M)

PART NO. : MA963.A.B1VW.002

6	5	4	3	2	1
				REV	
				D06	

## 6. Packaging

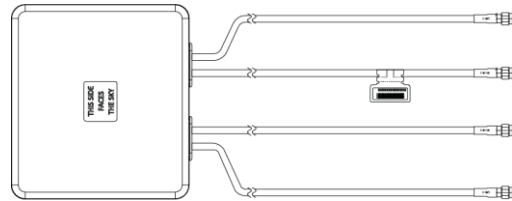

1 MA963.A.BIVW.002 per small box  
 Box Dimensions - 260\*240\*100mm  
 Weight - 750g

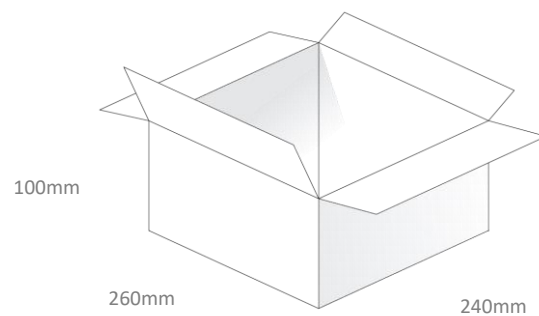

Box Dimensions - 540\*490\*240mm  
 8 pcs MA963.A.BIVW.002 per carton  
 Weight - 7Kg

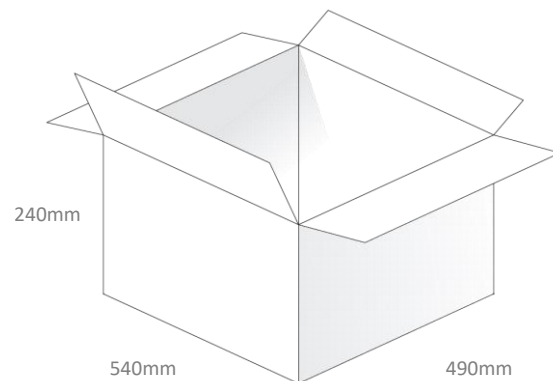

Pallet Dimensions:  
 1200\*1000\*1400mm  
 20 Cartons per Pallet  
 4 Cartons per layer, 5 Layers

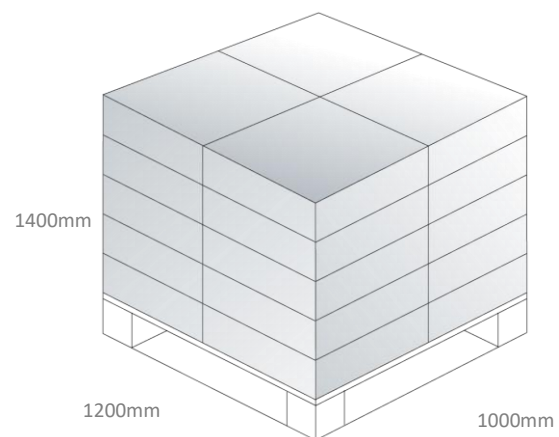

Changelog for the datasheet

**SPE-19-8-051 – MA963.A.B1VW.002**

**Revision: D (Current Versions)**

Date:	2022-06-27
Notes:	Updated Drawing
Author:	Cesar Sousa

**Previous Revisions**

**Revision: C**

Date:	2021-02-26
Notes:	Updated Packaging
Author:	Jack Conroy

**Revision: B**

Date:	2020-04-28
Notes:	Updated Drawing
Author:	Jack Conroy

**Revision: A (Original First Release)**

Date:	2019-04-16
Notes:	Initial Datasheet Release
Author:	Yu Kai Yeung



**TAOGLAS**®

[www.taoglas.com](http://www.taoglas.com)