



ANT-868-CPA

868 MHz Directional Embedded Ceramic Patch Antenna

The 868-CPA compact ceramic patch antenna offers directional signaling at 868 MHz with a footprint of only 25 mm x 25 mm on a recommended ground plane size of 70 mm x 70 mm.

The 868-CPA antenna is ideal for low-power, wide-area (LPWA) applications including LoRaWAN®, Sigfox®, remote controls and other 868 MHz ISM band applications where directional signaling is desired.

The 868-CPA antenna mounts to the printed circuit board (PCB) using re-peelable 5000NS adhesive backing which allows for repositioning or reorientation of the antenna. The pin-type connection feeds through the PCB where it is soldered to the feed line.

FEATURES

- Directional radiation pattern orthogonal to antenna surface
- Compact size, 25 mm x 25 mm x 4 mm
- Peak gain: 1.4 dBi when used with a 70 mm x 70 mm ground plane. Larger ground planes provide increased gain performance
- Pin-mount solder connection for direct PCB attachment
- Right-hand circularly polarized (RHCP)
- Durable re-peelable self-adhesive backing

APPLICATIONS

- Low-power, wide-area (LPWA) applications
 - LoRaWAN®
 - Sigfox®
 - WiFi HaLow™ (802.11ah)
- Smart Home networking
 - Security systems
 - Home weather stations
- Remote sensing, monitoring and control
 - Security systems
 - Industrial machinery
 - Keyless entry systems
 - UHF RFID devices
- Hand-held devices

ORDERING INFORMATION

Part Number	Description
ANT-868-CPA	868 MHz ceramic patch antenna

Available from Linx Technologies and select distributors and representatives.

ELECTRICAL SPECIFICATIONS

Frequency Range	863 MHz to 870 MHz
VSWR (max.)	9.5
Return Loss (max.)	-1.8
Peak Gain (dBi)	1.4
Average Gain (dBi)	-5.9
Efficiency (%)	33
Polarization	RHCP
Radiation	Directional
Max Power	8 W
Wavelength	1/4-wave
Electrical Type	Radiating patch
Impedance	50 Ω
Connection	Pin type
Weight	13.2 g (0.46 oz)
Dimensions	25.0 mm x 25.0 mm x 4.0 mm (1.00 in x 1.00 in x 0.16 in)
Operating Temperature Range	-40 °C to +85 °C
ESD Sensitivity	NOT ESD sensitive. As a best practice, Linx may use ESD packaging.

Electrical specifications and plots measured with a 70 mm x 70 mm (2.8 in x 2.8 in) ground plane

PRODUCT DIMENSIONS

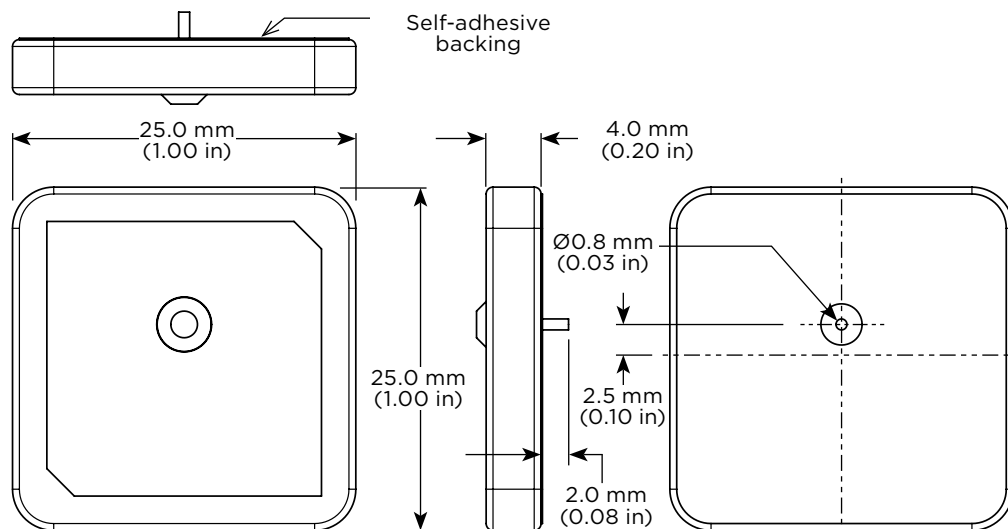

Figure 1. 868-CPA Antenna Dimensions

GROUND PLANE

Ceramic patch antennas are directional in signal transmission and reception orthogonal to the surface plane of the antenna, and require a ground plane for proper operation. The larger the ground plane, the narrower the antenna signal beam, and generally, the better the VSWR performance of the antenna. Relatively smaller ground planes produce wider signal beams. Linx recommends the ground plane size shown in the Electrical Specifications table to achieve performance similar to that shown in this datasheet.

VSWR

Figure 2 provides the voltage standing wave ratio (VSWR) across the antenna bandwidth. VSWR describes the power reflected from the antenna back to the radio. A lower VSWR value indicates better antenna performance at a given frequency. Reflected power is also shown on the right-side vertical axis as a gauge of the percentage of transmitter power reflected back from the antenna.

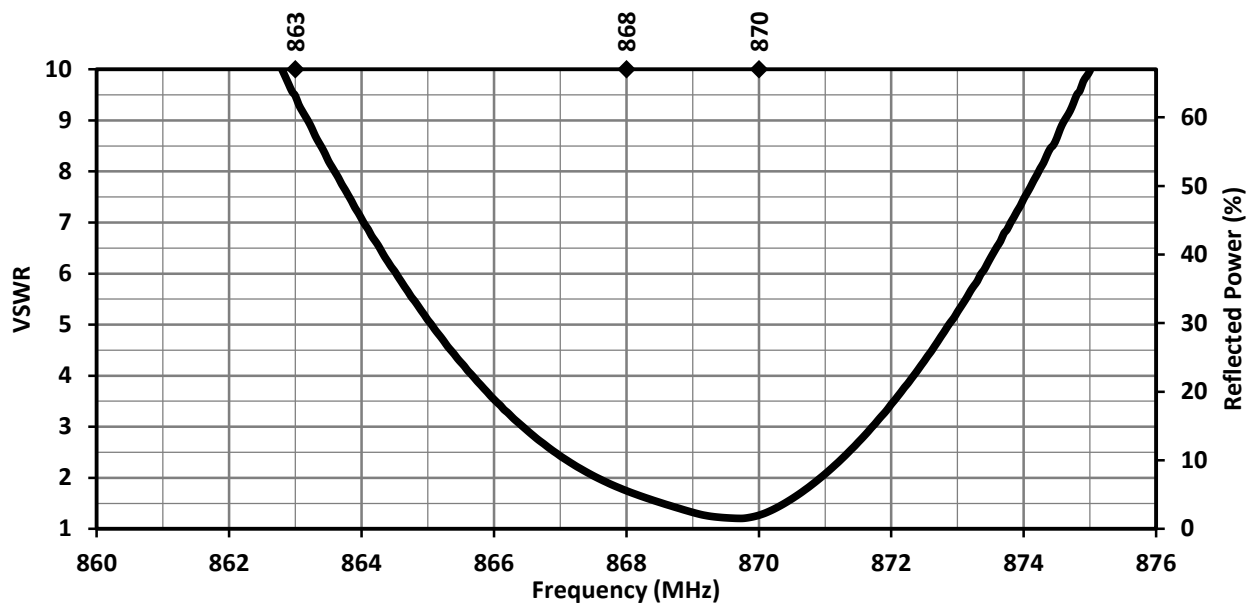

Figure 2. 868-CPA VSWR

RETURN LOSS

Return loss (Figure 3), represents the loss in power at the antenna due to reflected signals. Like VSWR, a lower return loss value indicates better antenna performance at a given frequency.

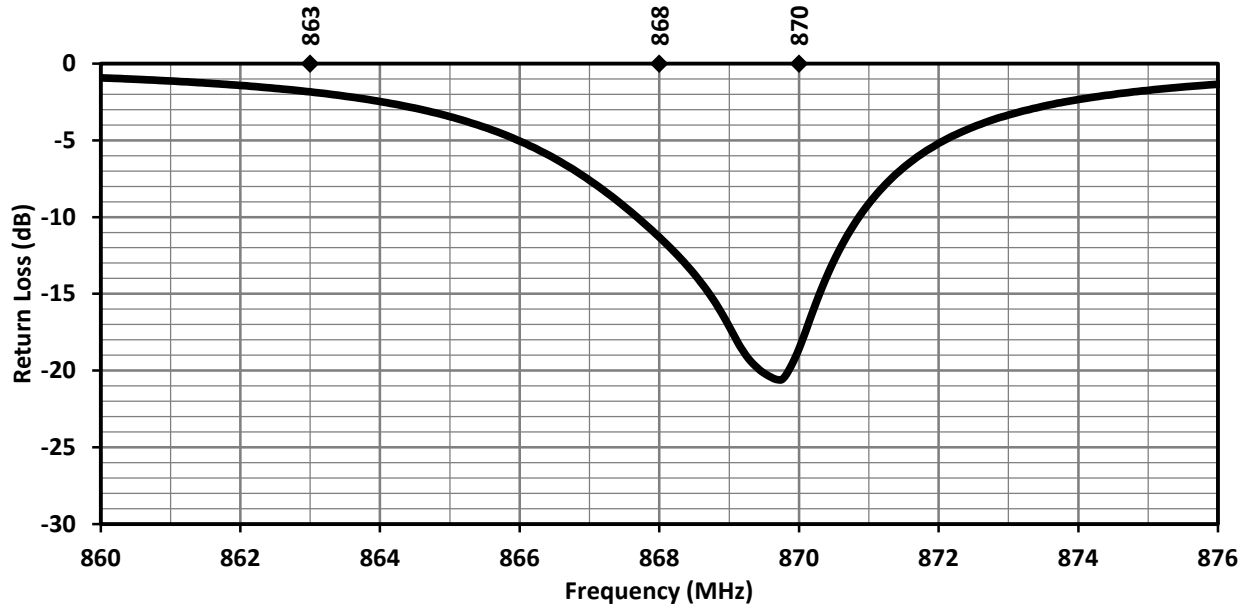

Figure 3. 868-CPA Return Loss

PEAK GAIN

The peak gain across the antenna bandwidth is shown in Figure 4. Peak gain represents the maximum antenna input power concentration across 3-dimensional space, and therefore peak performance at a given frequency, but does not consider any directionality in the gain pattern.

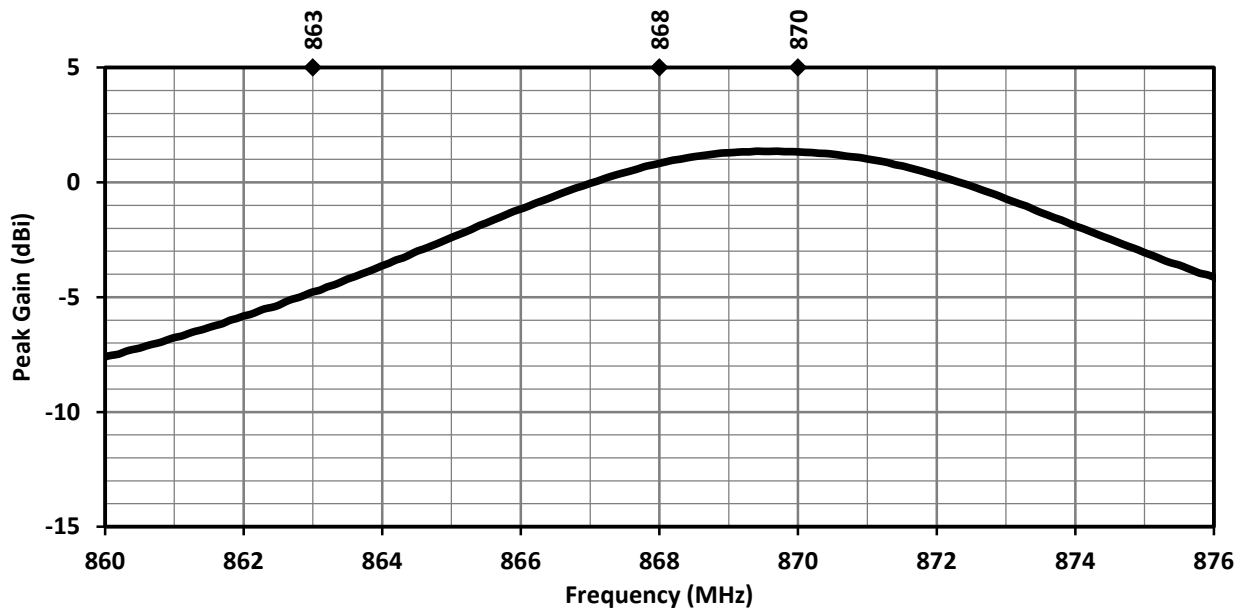

Figure 4. 868-CPA Peak Gain

RADIATION EFFICIENCY

Radiation efficiency (Figure 5), shows the ratio of power delivered to the antenna relative to the power radiated at the antenna, expressed as a percentage, where a higher percentage indicates better performance at a given frequency.

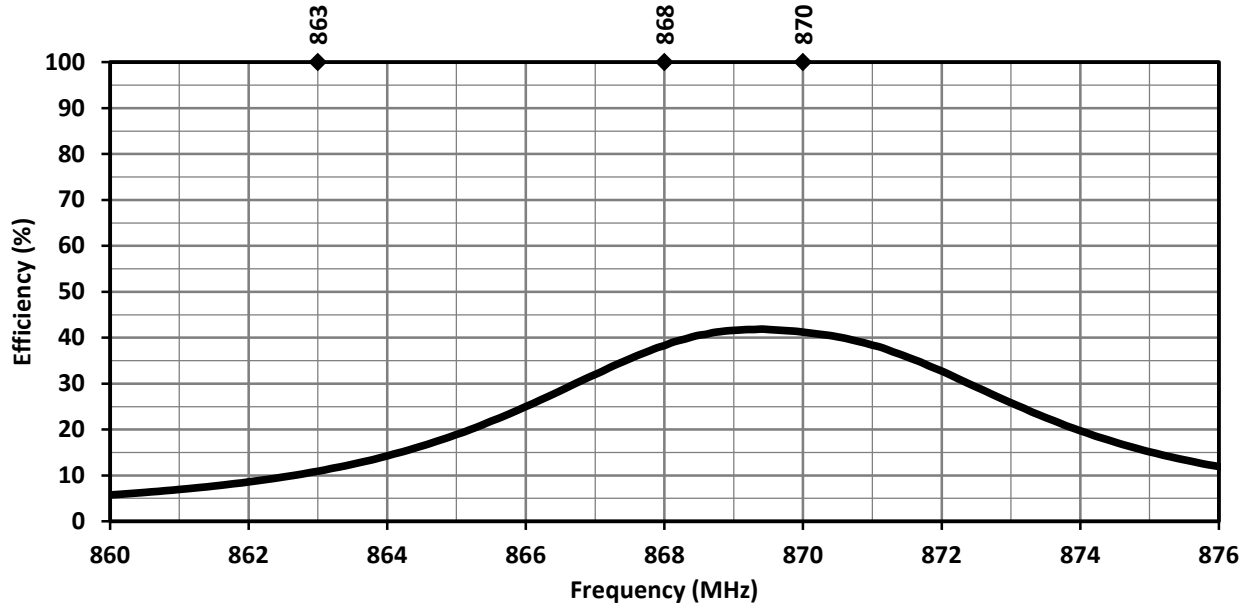
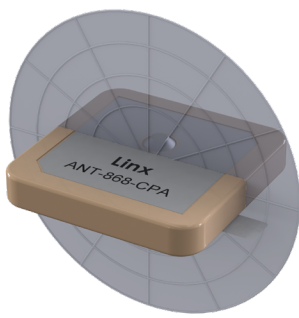

Figure 5. 868-CPA Antenna Radiation Efficiency

RADIATION PATTERNS

Radiation patterns provide information about the directionality and 3-dimensional gain performance of the antenna by plotting gain at specific frequencies in three orthogonal planes. Antenna radiation patterns are shown in Figure 6 using polar plots covering 360 degrees. The antenna graphic at the top of the page provides reference to the plane of the column of plots below it. Note: when viewed with typical PDF viewing software, zooming into radiation patterns is possible to reveal fine detail.



XZ-Plane Gain

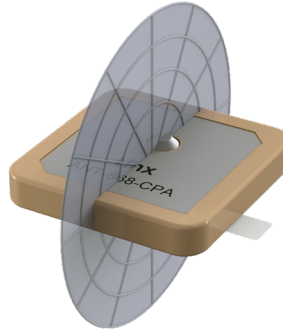

YZ-Plane Gain

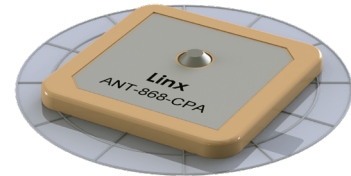

XY-Plane Gain

863 MHZ TO 870 MHZ (868 MHZ)

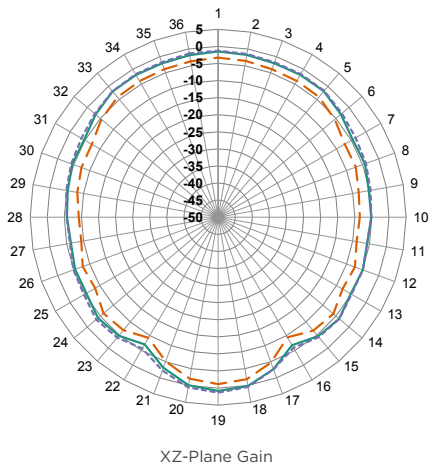

XZ-Plane Gain

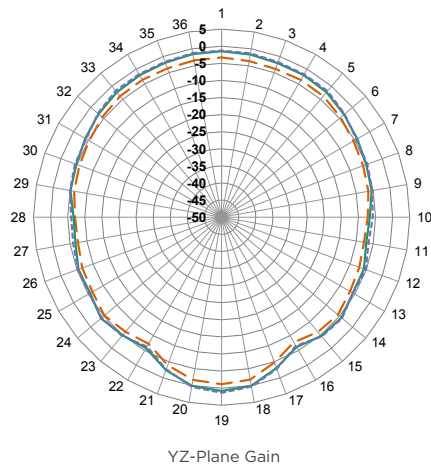

YZ-Plane Gain

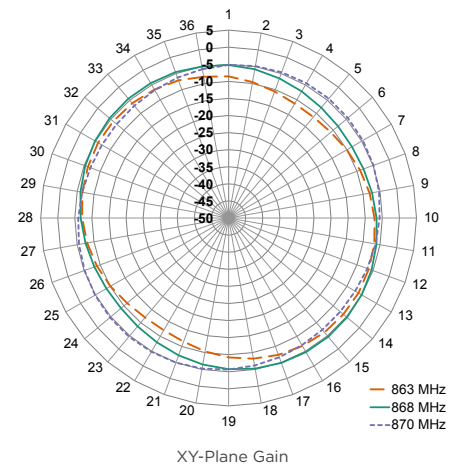

XY-Plane Gain

Figure 6. Radiation Patterns for 868-CPA Antenna

TE TECHNICAL SUPPORT CENTER

USA:	+1 (800) 522-6752
Canada:	+1 (905) 475-6222
Mexico:	+52 (0) 55-1106-0800
Latin/S. America:	+54 (0) 11-4733-2200
Germany:	+49 (0) 6251-133-1999
UK:	+44 (0) 800-267666
France:	+33 (0) 1-3420-8686
Netherlands:	+31 (0) 73-6246-999
China:	+86 (0) 400-820-6015

te.com

TE Connectivity, TE, TE connectivity (logo), Linx and Linx Technologies are trademarks owned or licensed by the TE Connectivity Ltd. family of companies. All other logos, products and/or company names referred to herein might be trademarks of their respective owners.

The information given herein, including drawings, illustrations and schematics which are intended for illustration purposes only, is believed to be reliable. However, TE Connectivity makes no warranties as to its accuracy or completeness and disclaims any liability in connection with its use. TE Connectivity's obligations shall only be as set forth in TE Connectivity's Standard Terms and Conditions of Sale for this product and in no case will TE Connectivity be liable for any incidental, indirect or consequential damages arising out of the sale, resale, use or misuse of the product. Users of TE Connectivity products should make their own evaluation to determine the suitability of each such product for the specific application.

TE Connectivity warrants to the original end user customer of its products that its products are free from defects in material and workmanship. Subject to conditions and limitations TE Connectivity will, at its option, either repair or replace any part of its products that prove defective because of improper workmanship or materials. This limited warranty is in force for the useful lifetime of the original end product into which the TE Connectivity product is installed. Useful lifetime of the original end product may vary but is not warranted to exceed one (1) year from the original date of the end product purchase.

©2022 TE Connectivity. All Rights Reserved.

11/22 Original