

ANT-LTE-RPC-ccc

LTE/LPWA Embedded Dipole Antenna

The ANT-LTE-RPC-ccc (RPC) is a rigid, adhesive-backed, multiband cellular and cellular IoT antenna (LTE-M and NB-IoT) for embedded applications requiring excellent 600 MHz, 700 MHz and 800 MHz band performance. The RPC also supports low-power, wide-area (LPWA) networking at 868 MHz and 915 MHz, 2.4 GHz ISM, and global navigation systems (GNSS/GPS).

The RPC provides a ground plane independent dipole embedded antenna solution comparable in performance to an external antenna. The RPC's adhesive backing makes it easy to mount in plastic enclosures, while allowing an environmentally sealed enclosure and protection from tampering or accidental antenna damage.

Connection is made to the radio via a 100 mm long, 1.13 mm coaxial cable terminated in an MHF1/U.FL-compatible plug connector or unterminated, trimmed for PCB mounting.

FEATURES

- 617 MHz to 960 MHz
 - VSWR: ≤ 2.5
 - Peak Gain: 6.3 dBi max.
 - Efficiency: 64%
- 1553 MHz to 1609 MHz (GNSS/GPS)
 - VSWR: ≤ 1.2
 - Peak Gain: 5.0 dBi max.
 - Efficiency: 77%
- Compact, low-profile
 - 98.4 mm x 14.9 mm x 0.8 mm
- MHF1/U.FL-compatible plug (female socket) on 100 mm of 1.13 mm coaxial cable
- 3M 9888T adhesive backing permanently adheres to a wide variety of materials

APPLICATIONS

- Worldwide LTE, UMTS and GSM
- Cellular IoT:
 - LTE-M (Cat-M1)
 - NB-IoT
- Low-power, wide-area (LPWA) networks
 - LoRaWAN®
 - Sigfox®
 - Wi-Fi HaLow™
- Smart Home networking
 - Security systems
 - Home weather stations
- ISM: Bluetooth® and ZigBee®
- Global Navigation (GNSS)
 - GPS, GLONASS, Galileo, BeiDou

ORDERING INFORMATION

Part Number	Description
ANT-LTE-RPC-UFL	Antenna with 100 mm of 1.13 mm coaxial cable and MHF1/U.FL-compatible plug (female socket)
ANT-LTE-RPC	Antenna with 100 mm of unterminated 1.13 mm coaxial cable

TABLE 1. ELECTRICAL SPECIFICATIONS

Select Bands	Frequency Range	VSWR (max.)	Peak Gain (dBi)	Avg. Gain (dBi)	Efficiency (%)
LTE 71	617 MHz to 698 MHz	2.5	3.6	-2.3	64
LTE 12, 13, 14, 17, 26, 28, 29	698 MHz to 803 MHz	1.8	4.9	-2.4	61
LTE 5, 8, 20	791 MHz to 960 MHz	2.4	6.3	-2.8	55
LTE 1, 2, 3, 4, 10, 25, 66	1710 MHz to 2200 MHz	1.8	5.1	-1.2	81
LTE 30, 40	2300 MHz to 2400 MHz	1.4	5.0	-1.4	73
LTE 7, 41	2496 MHz to 2690 MHz	2.1	4.6	-1.8	70
LTE 22, 42, 43, 48, 49, 52	3300 MHz to 3800 MHz	4.1	3.1	-5.9	35
GNSS/GPS	1553 MHz to 1609 MHz	1.2	5.0	-1.2	77
ISM	2400 MHz to 2485 MHz	1.5	4.8	-1.9	66

Polarization	Linear	Wavelength	1/2-wave
Radiation	Omnidirectional	Electrical Type	Dipole
Max Power	2 W	Impedance	50 Ω
Cable	100 mm of 1.13 mm coaxial cable		
Termination	ANT-LTE-RPC-UFL: MHF1/U.FL-compatible plug (female socket) ANT-LTE-RPC: unterminated, trimmed for PCB mounting		
Weight	3.2 g (0.11 oz)		
Dimensions	98.4 mm x 14.9 mm x 0.8 mm (3.87 in x 0.59 in x 0.03 in)		
Operating Temp. Range	-20 °C to +65 °C		
ESD Sensitivity	NOT ESD sensitive. As a best practice, Linx may use ESD packaging.		

Electrical specifications and plots measured on a 2.0 mm (0.08 in) thick acrylic sheet

PRODUCT DIMENSIONS

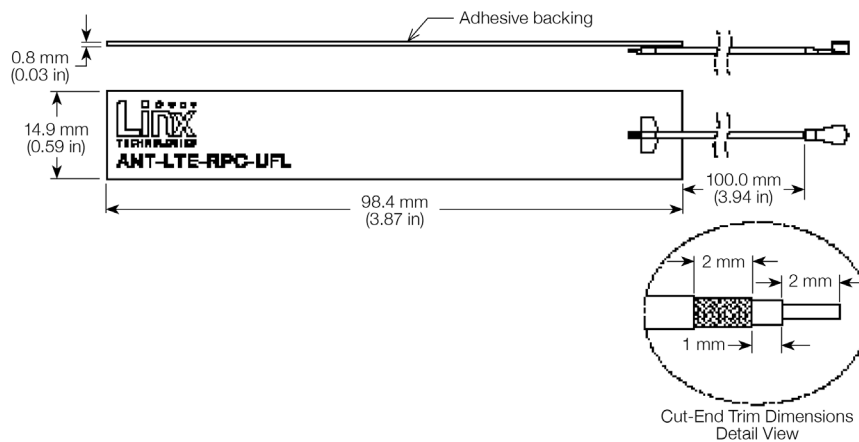

Figure 1. ANT-LTE-RPC-ccc Product Dimensions

ANTENNA MOUNTING

The ANT-LTE-RPC-ccc is an adhesive backed, embedded antenna that may be permanently installed onto a wide variety of materials. The adhesive backing is 3M 9888T, which provides outstanding adhesion to low surface energy plastics.

- 3M 9888T features a medium-soft acrylic pressure sensitive adhesive system. The key characteristics of this adhesive include a combination of high initial adhesion and good shear and bonding power to a wide variety of materials, including many plastics including polyethylene and polypropylene
- 3M 9888T is UL-recognized (File MH28421). Please see UL listing for details

VSWR

Figure 2 provides the voltage standing wave ratio (VSWR) across the antenna bandwidth. VSWR describes the power reflected from the antenna back to the radio. A lower VSWR value indicates better antenna performance at a given frequency. Reflected power is also shown on the right-side vertical axis as a gauge of the percentage of transmitter power reflected back from the antenna.

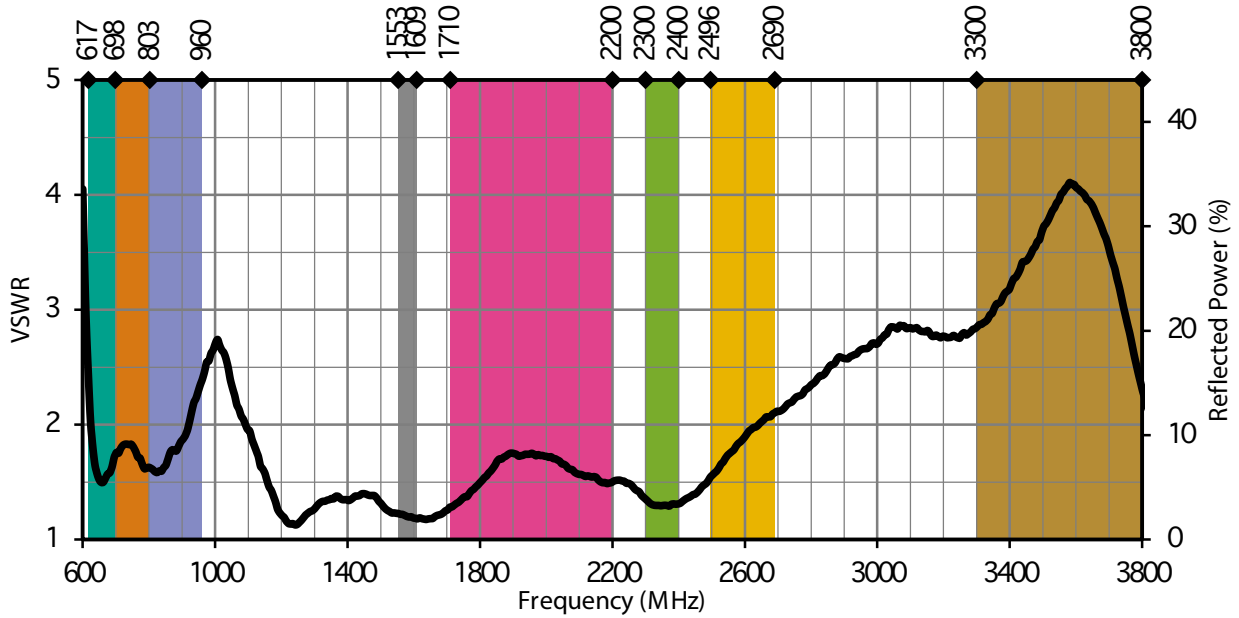

Figure 2. RPC Antenna VSWR with Frequency Band Highlights

RETURN LOSS

Return loss (Figure 3), represents the loss in power at the antenna due to reflected signals. Like VSWR, a lower return loss value indicates better antenna performance at a given frequency.

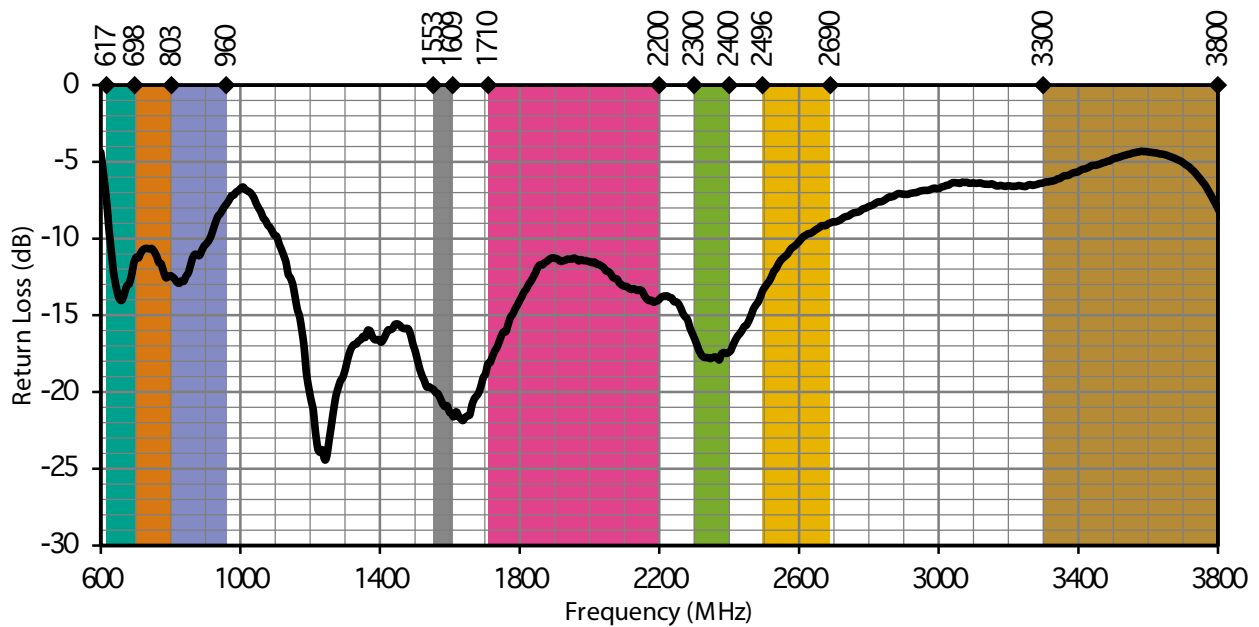

Figure 3. RPC Antenna Return Loss with Frequency Band Highlights

PEAK GAIN

The peak gain across the antenna bandwidth is shown in Figure 4. Peak gain represents the maximum antenna input power concentration across 3-dimensional space, and therefore peak performance, at a given frequency, but does not consider any directionality in the gain pattern.

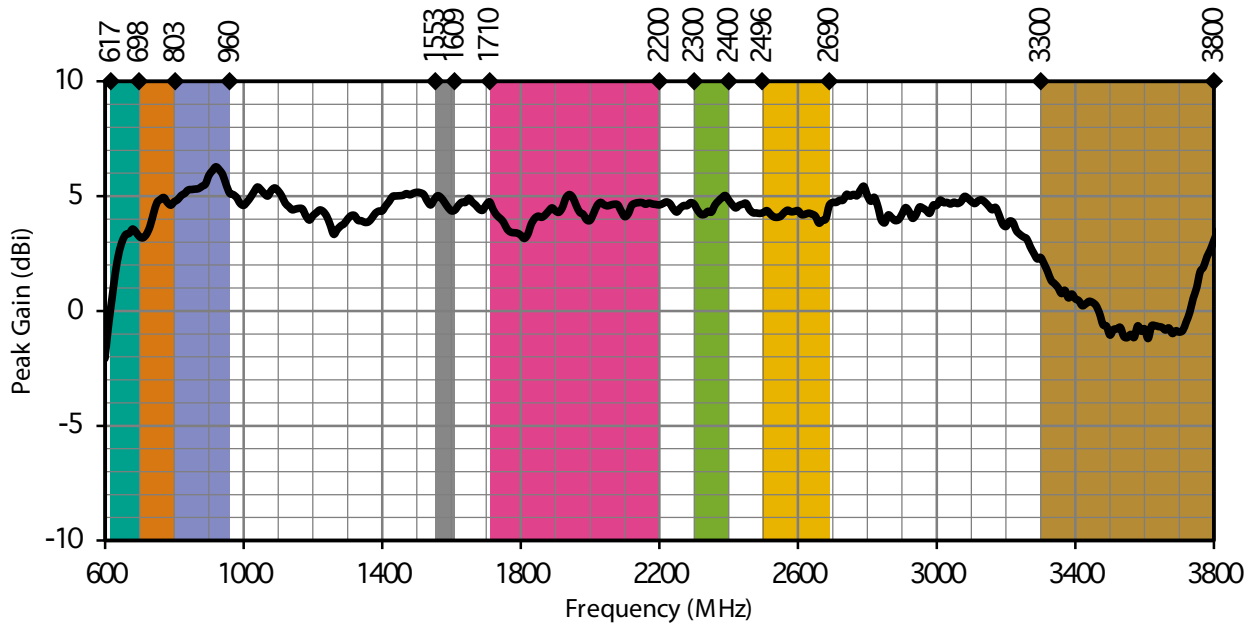

Figure 4. RPC Antenna Peak Gain with Frequency Band Highlights

AVERAGE GAIN

Average gain (Figure 5), is the average of all antenna gain in 3-dimensional space at each frequency, providing an indication of overall performance without expressing antenna directionality.

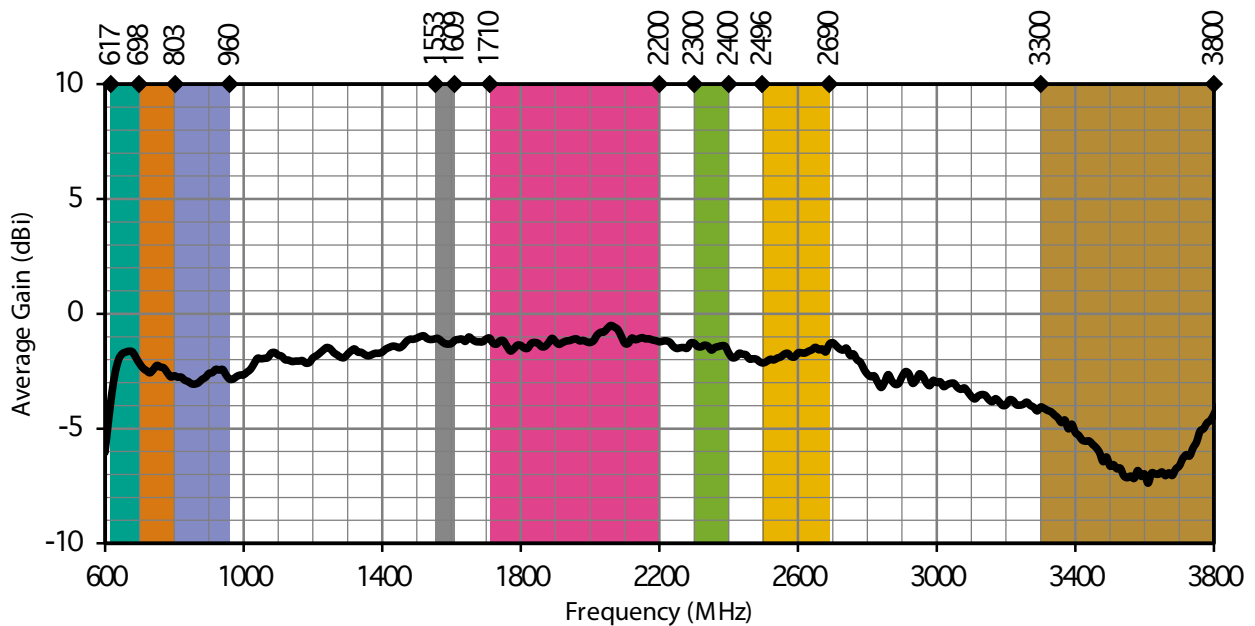

Figure 5. RPC Antenna Average Gain with Frequency Band Highlights

RADIATION EFFICIENCY

Radiation efficiency (Figure 6), shows the ratio of power delivered to the antenna relative to the power radiated at the antenna, expressed as a percentage, where a higher percentage indicates better performance at a given frequency.

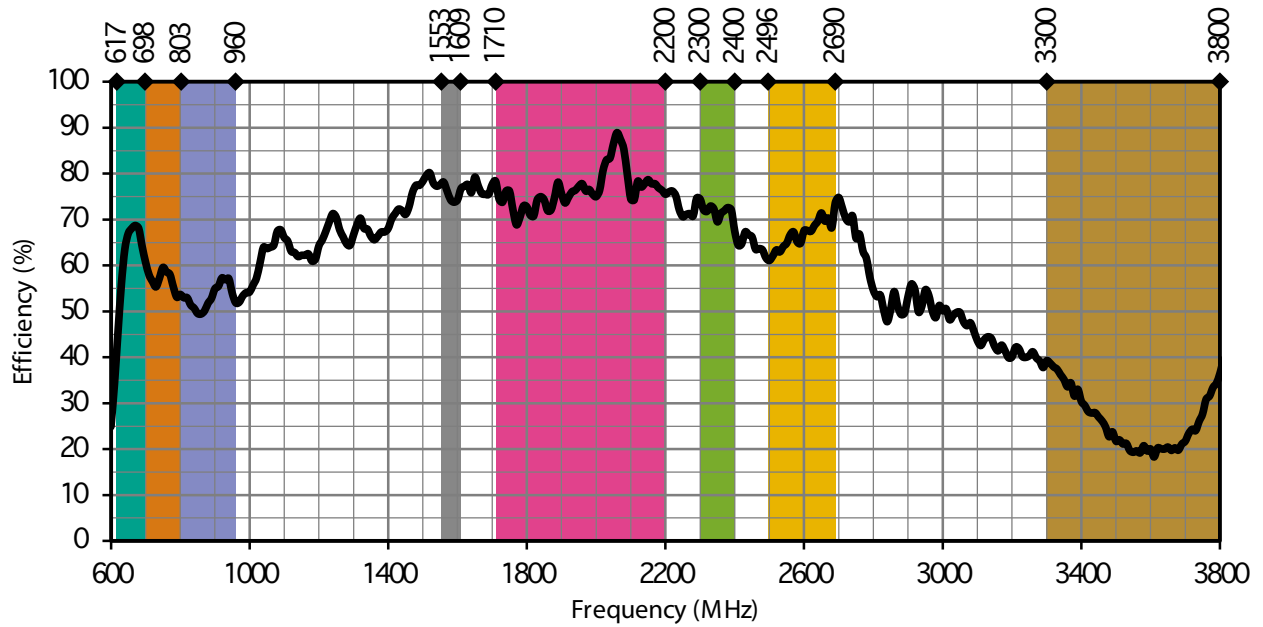
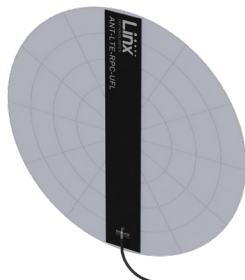

Figure 6. RPC Antenna Radiation Efficiency with Frequency Band Highlights

RADIATION PATTERNS

Radiation patterns provide information about the directionality and 3-dimensional gain performance of the antenna by plotting gain at specific frequencies in three orthogonal planes. Antenna radiation patterns (Figure 7), are shown using polar plots covering 360 degrees. The antenna graphic above the plots provides reference to the plane of the column of plots below it. Note: when viewed with typical PDF viewing software, zooming into radiation patterns is possible to reveal fine detail.



XZ-Plane Gain



YZ-Plane Gain

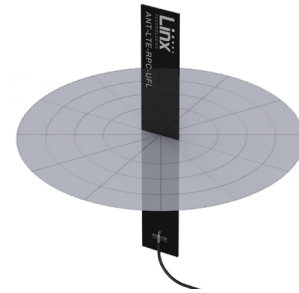

XY-Plane Gain

617 MHZ TO 698 MHZ (658 MHZ)

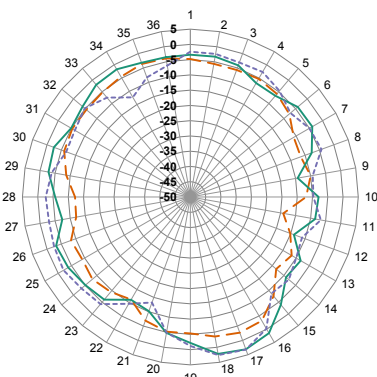

XZ-Plane Gain

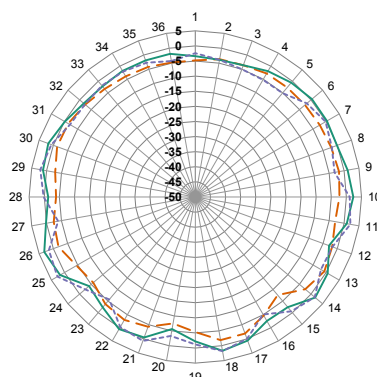

YZ-Plane Gain

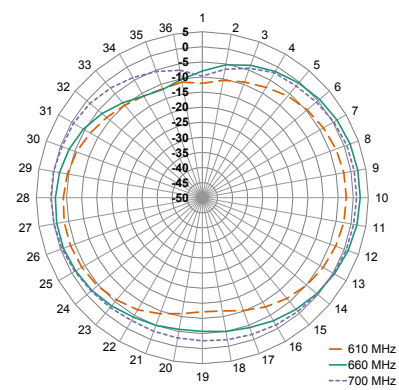

XY-Plane Gain

698 MHZ TO 803 MHZ (750 MHZ)

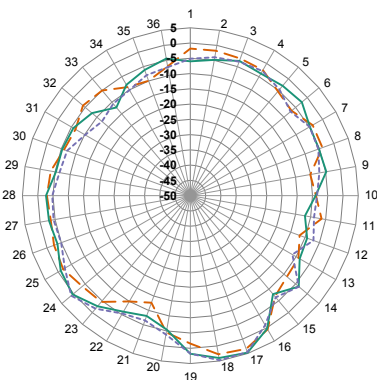

XZ-Plane Gain

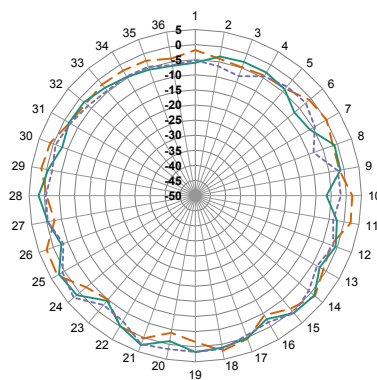

YZ-Plane Gain

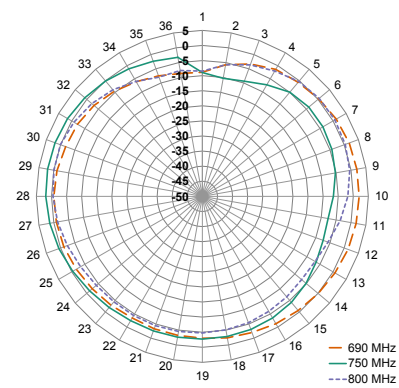

XY-Plane Gain

790 MHz TO 960 MHz (870 MHz)

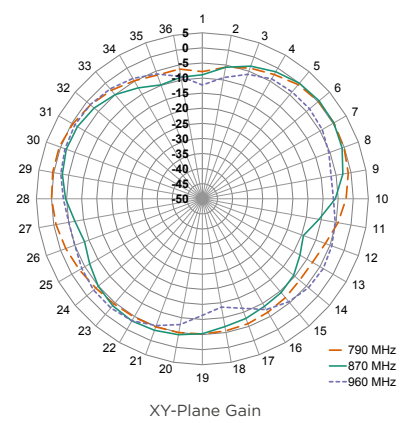
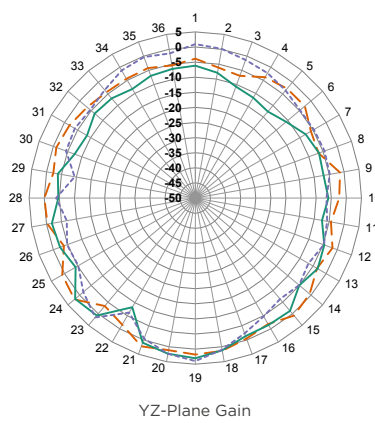
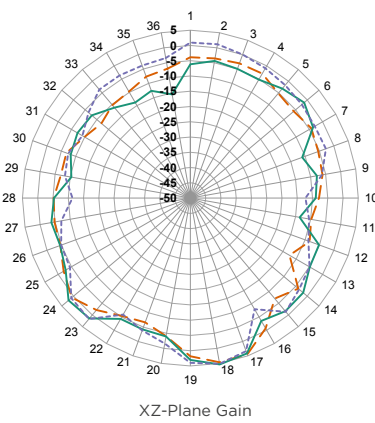

1710 MHz TO 2200 MHz (1950 MHz)

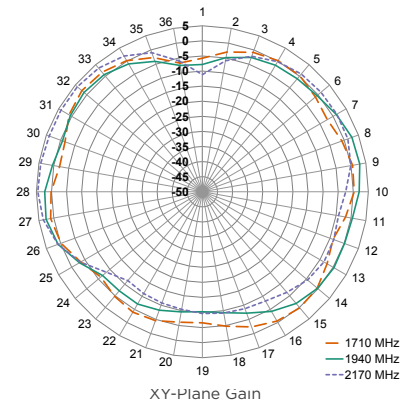
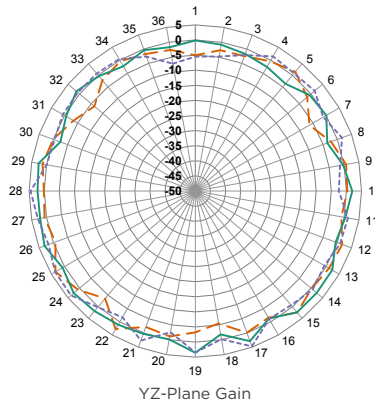
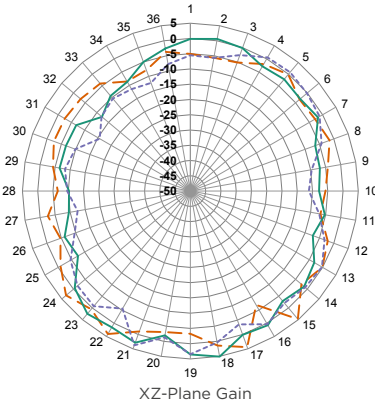

2300 MHz TO 2400 MHz (2350 MHz)

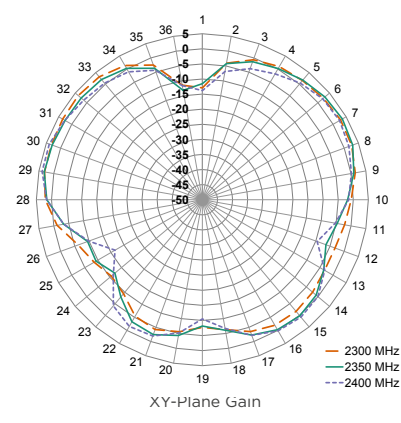
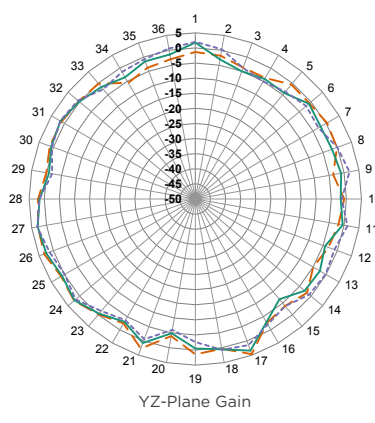
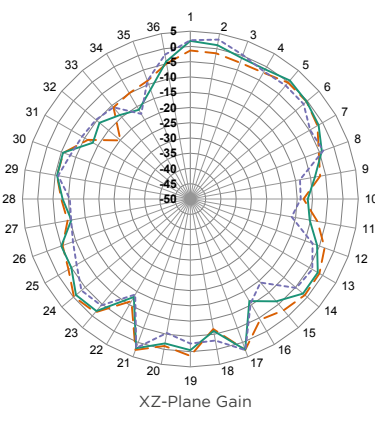

2496 MHZ TO 2690 MHZ (2600 MHZ)

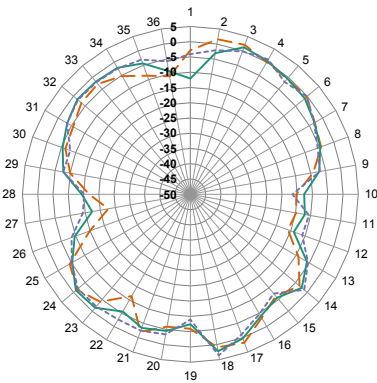

XZ-Plane Gain

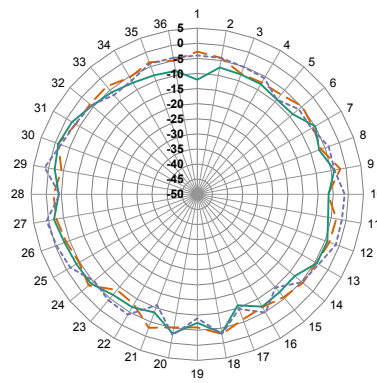

YZ-Plane Gain

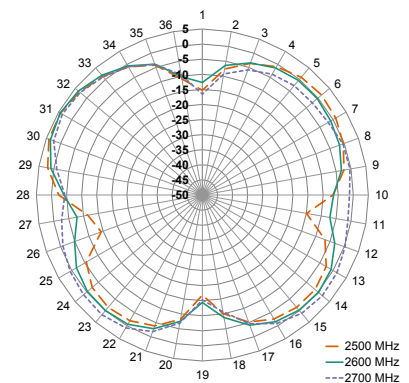

XY-Plane Gain

3300 MHZ TO 3800 MHZ (3550 MHZ)

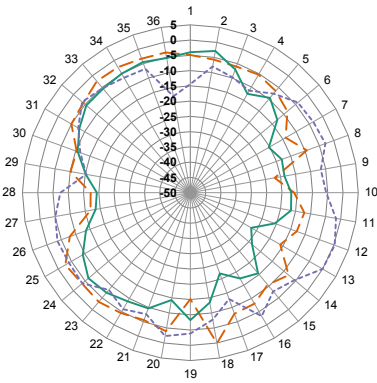

XZ-Plane Gain

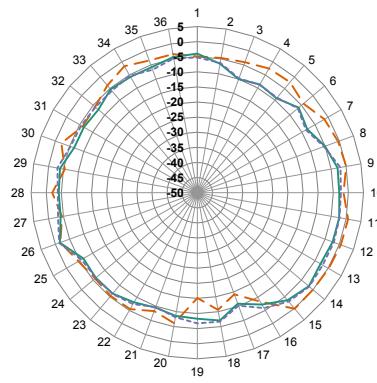

YZ-Plane Gain

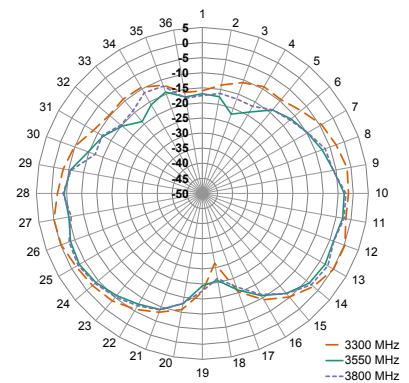

XY-Plane Gain

1553 MHZ TO 1609 MHZ (1580 MHZ)

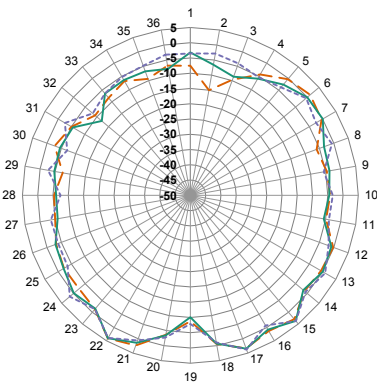

XZ-Plane Gain

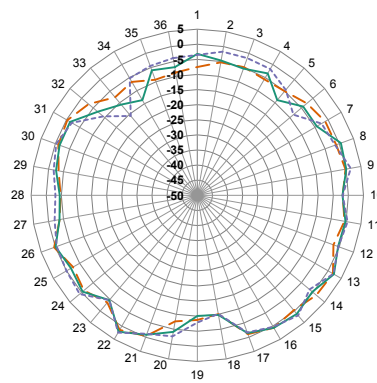

YZ-Plane Gain

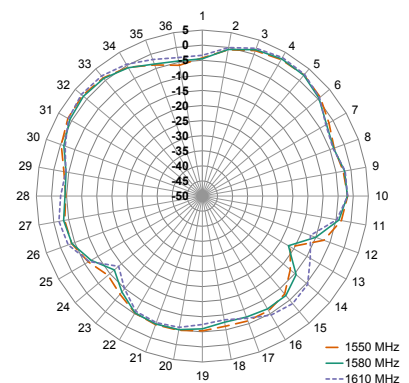

XY-Plane Gain

2400 MHZ TO 2490 MHZ (2450 MHZ)

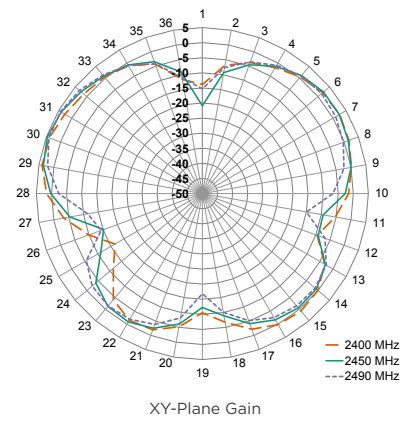
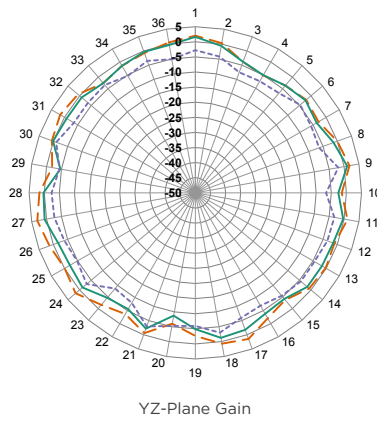
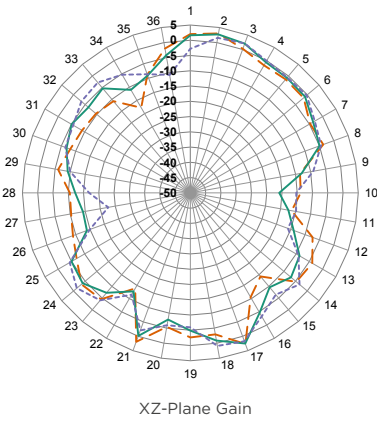

TE TECHNICAL SUPPORT CENTER

USA:	+1 (800) 522-6752
Canada:	+1 (905) 475-6222
Mexico:	+52 (0) 55-1106-0800
Latin/S. America:	+54 (0) 11-4733-2200
Germany:	+49 (0) 6251-133-1999
UK:	+44 (0) 800-267666
France:	+33 (0) 1-3420-8686
Netherlands:	+31 (0) 73-6246-999
China:	+86 (0) 400-820-6015

te.com

TE Connectivity, TE, TE connectivity (logo), Linx and Linx Technologies are trademarks owned or licensed by the TE Connectivity Ltd. family of companies. All other logos, products and/or company names referred to herein might be trademarks of their respective owners.

The information given herein, including drawings, illustrations and schematics which are intended for illustration purposes only, is believed to be reliable. However, TE Connectivity makes no warranties as to its accuracy or completeness and disclaims any liability in connection with its use. TE Connectivity's obligations shall only be as set forth in TE Connectivity's Standard Terms and Conditions of Sale for this product and in no case will TE Connectivity be liable for any incidental, indirect or consequential damages arising out of the sale, resale, use or misuse of the product. Users of TE Connectivity products should make their own evaluation to determine the suitability of each such product for the specific application.

TE Connectivity warrants to the original end user customer of its products that its products are free from defects in material and workmanship. Subject to conditions and limitations TE Connectivity will, at its option, either repair or replace any part of its products that prove defective because of improper workmanship or materials. This limited warranty is in force for the useful lifetime of the original end product into which the TE Connectivity product is installed. Useful lifetime of the original end product may vary but is not warranted to exceed one (1) year from the original date of the end product purchase.

©2022 TE Connectivity. All Rights Reserved.

09/22 Original