

5G NR/ 4G/ LTE Ceramic Chip Antenna



ACR4006X

Request Samples



Check Inventory



40 x 6 x 5 mm

RoHS/RoHS II Compliant

MSL Level = N/A

Features

- Ultra-wide band 600 MHz ~ 6 GHz
- Compact & Low-Profile
- VSWR: ≤ 2.0
- Peak Gain: 3.7 dBi
- Efficiency: up to 60%
- Linear Polarization
- Surface Mount (SMD)
- High efficiency across cellular bands

Applications

- Internet of Things (IoT) devices
- LTE-M, Cat M, Cat M1, NB-IoT
- LTE CAT 1 up to CAT 20 supported
- CBRS and 5G bands supported
- Smart Home networking
- Networking & Telecommunication

Product Image

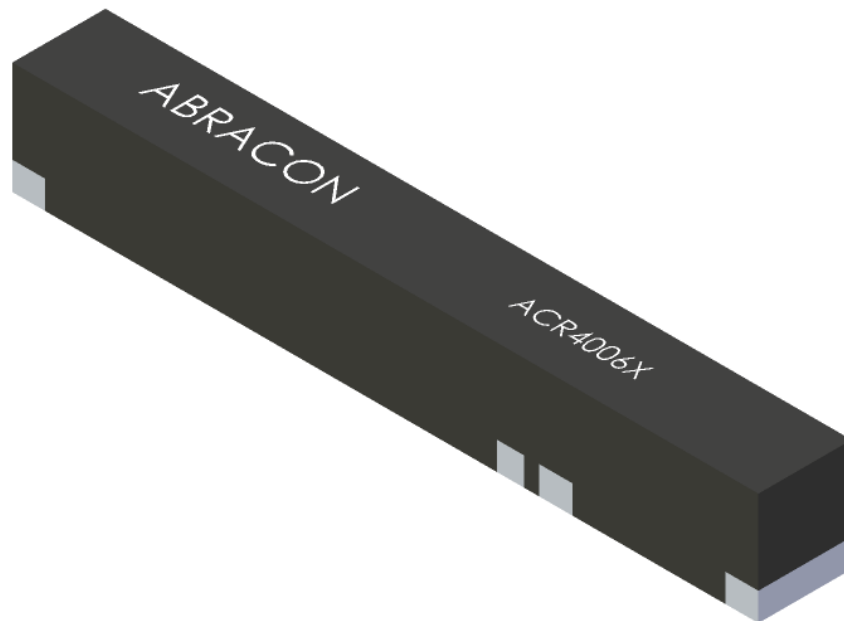

5G NR/ 4G/ LTE Ceramic Chip Antenna



ACR4006X

Request Samples



Check Inventory



40 x 6 x 5 mm

RoHS/RoHS II Compliant

MSL Level = N/A

Electrical Specification

Parameter	Specification			Unit
Operating Frequency	617-960	1710-2690	3300-6000	MHz
VSWR (Typ.)	< 2.0			
Peak Gain	0.4	3.7	3.5	dBi
Efficiency (Maximum)	56	60	48	%
Impedance	50			Ω
Polarization	Linear			
Radiation Pattern (Azimuth)	Omni-directional			

Note : All test measurements were conducted on 120 x 45 mm. Performance of the chip antenna will vary relative to the ground plane size in use.

Mechanical Specification

Parameter	Specification
Antenna Dimension	40 x 6 x 5 mm
Antenna Clearance Space	45 x 13 mm
Evaluation Board size	120 x 45 mm
Solder Termination	Ag (Environmental-Friendly Pb-Free)

Environmental Specification

Parameter	Specification
Operating Temperature	-40°C to 85°C
Storage Temperature	-40°C to 85°C
Relative Humidity	90% to 95%

5G NR/ 4G/ LTE Ceramic Chip Antenna



ACR4006X

Request Samples



Check Inventory



40 x 6 x 5 mm

RoHS/RoHS II Compliant

MSL Level = N/A

Product Dimensions

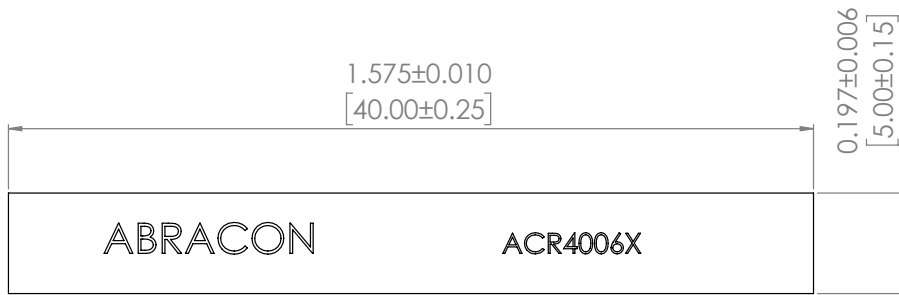

TOP VIEW

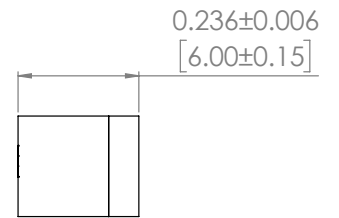

SIDE VIEW

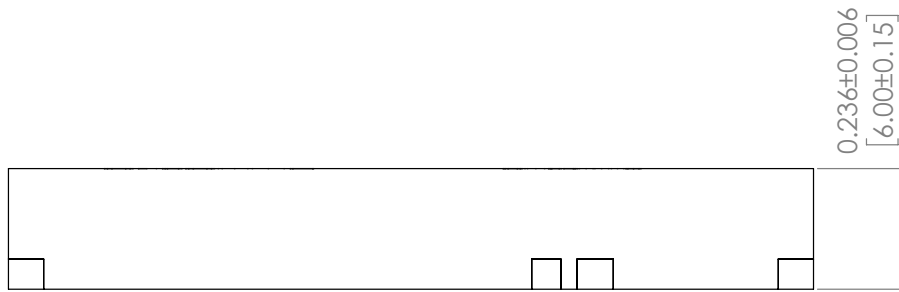

FRONT VIEW

Unit: inched[mm]

5G NR/ 4G/ LTE Ceramic Chip Antenna



ACR4006X

Request Samples



Check Inventory



40 x 6 x 5 mm

RoHS/RoHS II Compliant

MSL Level = N/A

Measurement Setup photo

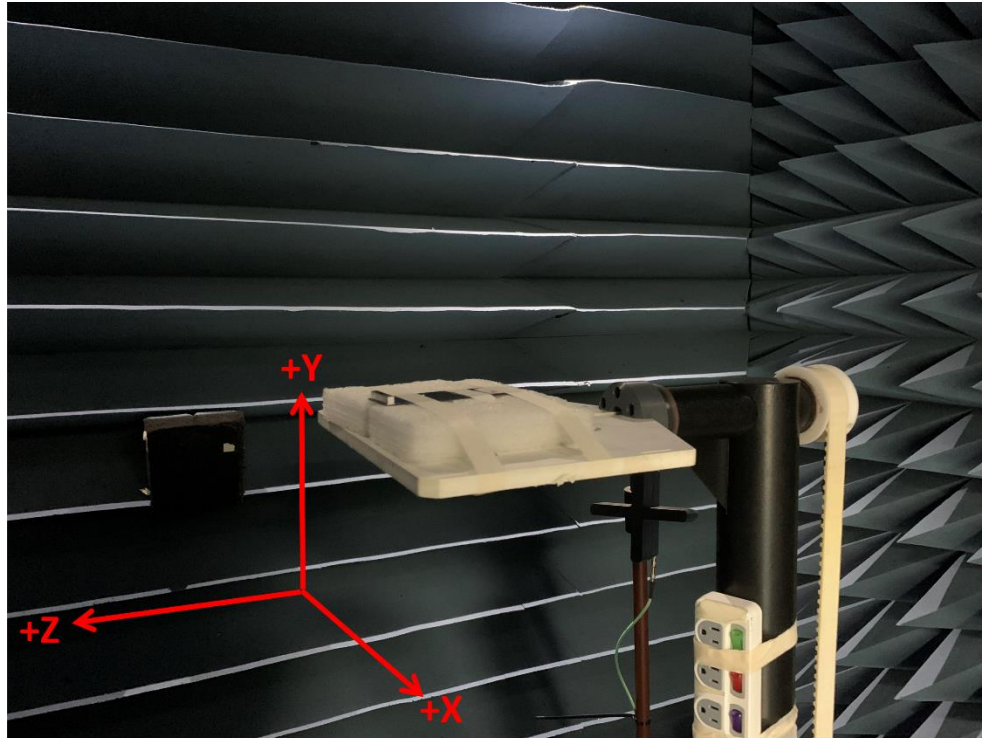

5G NR/ 4G/ LTE Ceramic Chip Antenna



ACR4006X

Request Samples



Check Inventory



40 x 6 x 5 mm

RoHS/RoHS II Compliant

MSL Level = N/A

Reflection Characteristics –Return Loss & VSWR

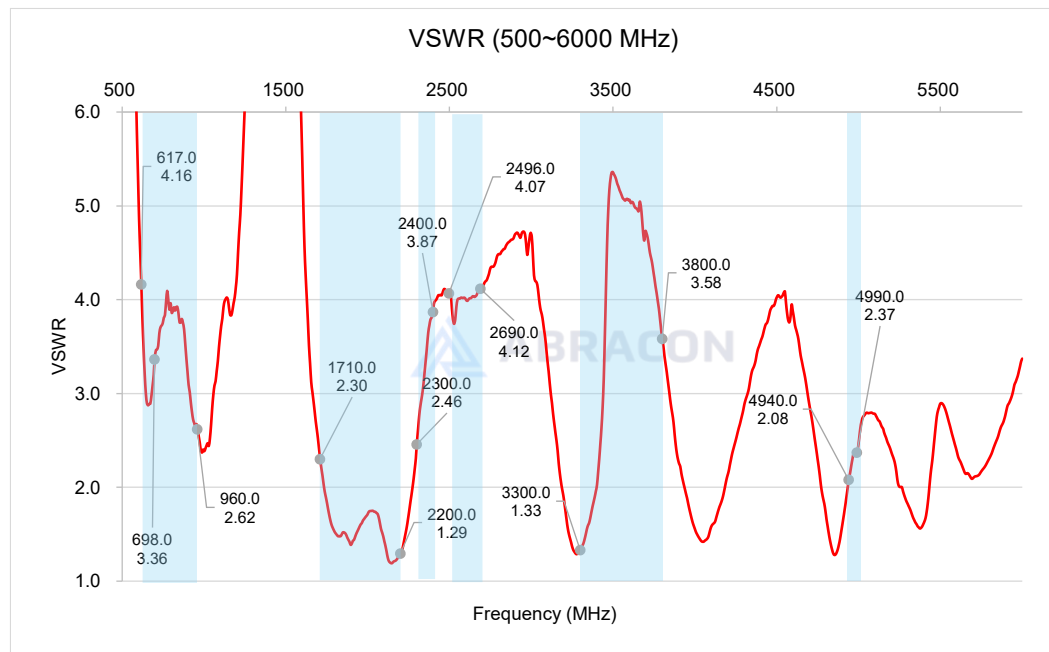
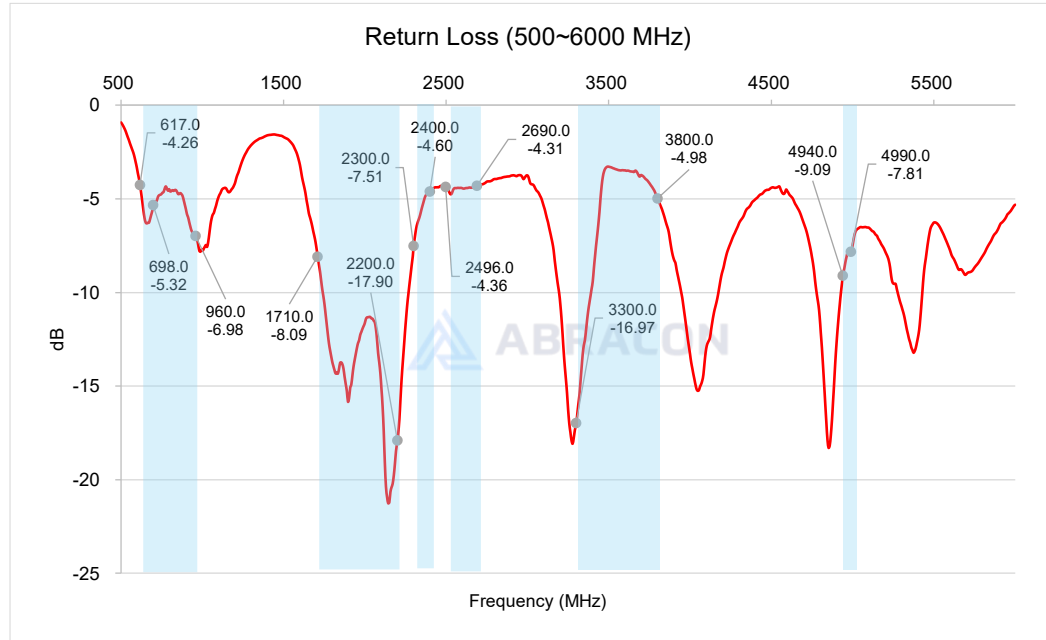

5G NR/ 4G/ LTE Ceramic Chip Antenna



ACR4006X

Request Samples



Check Inventory



40 x 6 x 5 mm

RoHS/RoHS II Compliant

MSL Level = N/A

Radiation Characteristics – Peak Gain

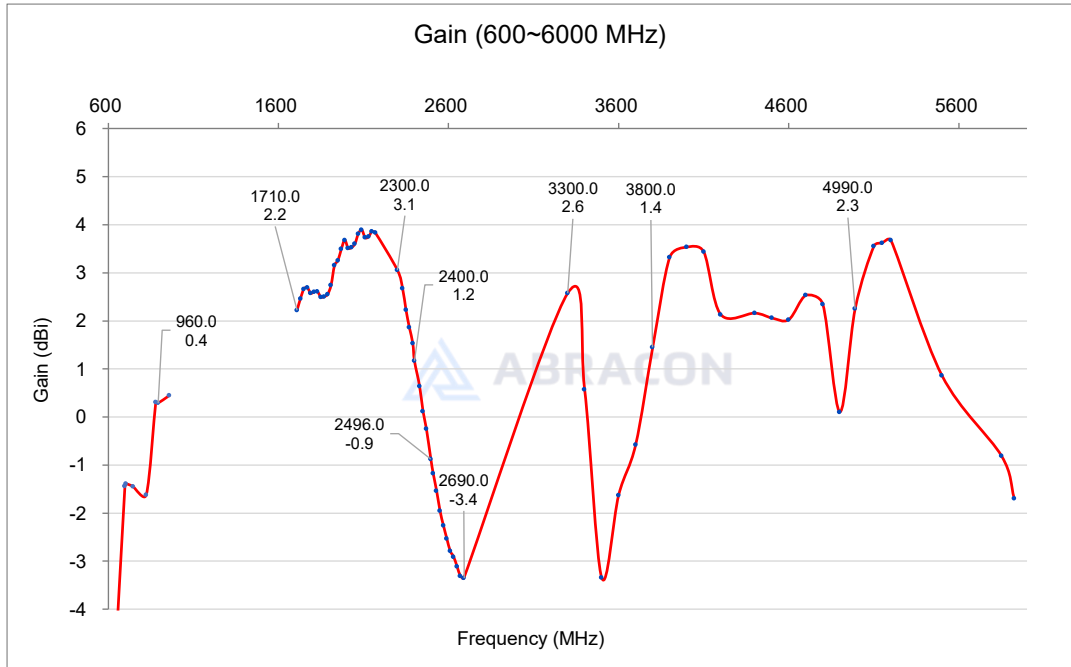

5G NR/ 4G/ LTE Ceramic Chip Antenna



ACR4006X

Request Samples



Check Inventory



40 x 6 x 5 mm

RoHS/RoHS II Compliant

MSL Level = N/A

Radiation Characteristics – Total Efficiency (%)

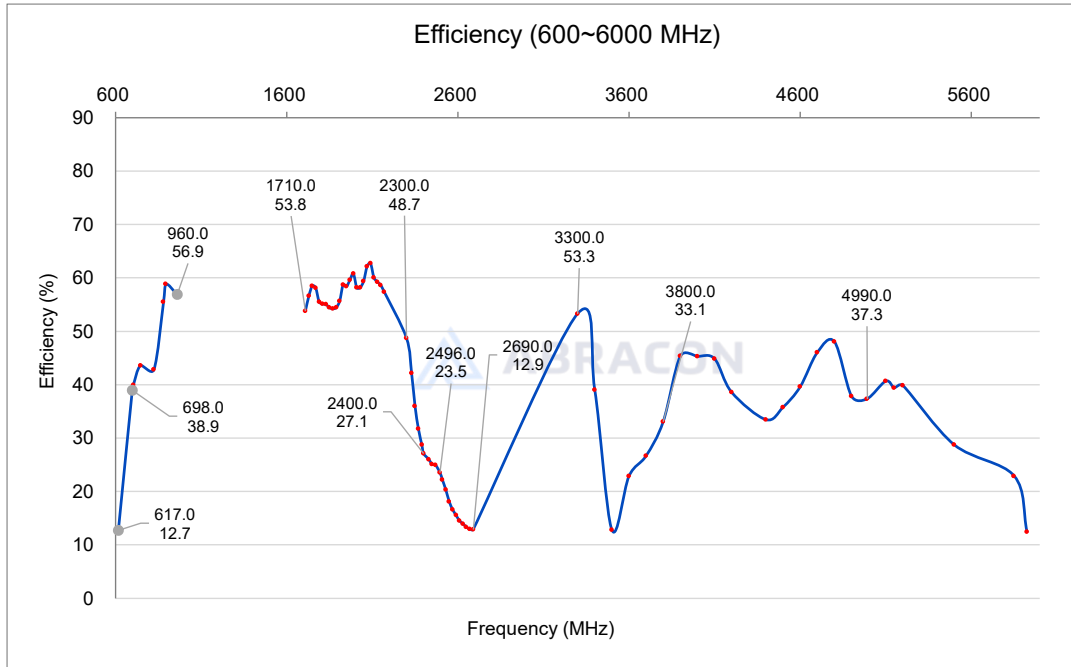

5G NR/ 4G/ LTE Ceramic Chip Antenna



ACR4006X

Request Samples



Check Inventory



40 x 6 x 5 mm

RoHS/RoHS II Compliant

MSL Level = N/A

Radiation Characteristics – 3D & 2D Pattern

698MHz

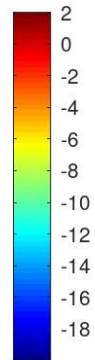
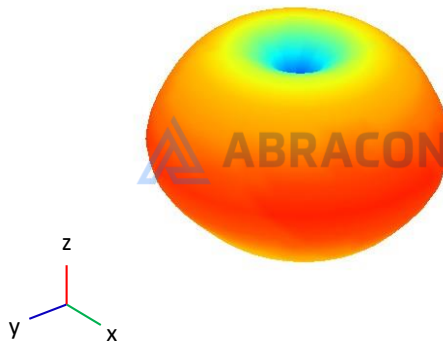
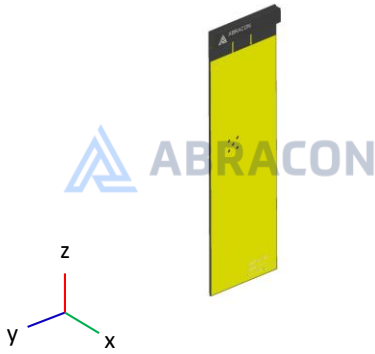

XY plane

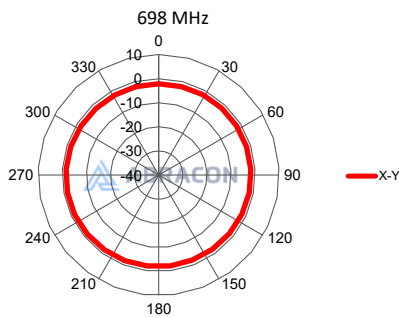

XZ plane

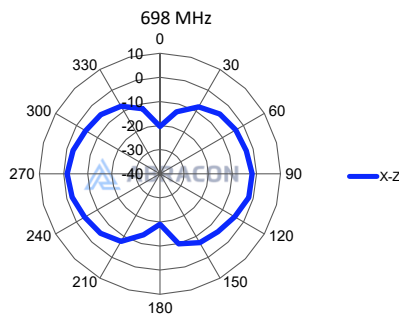

YZ plane

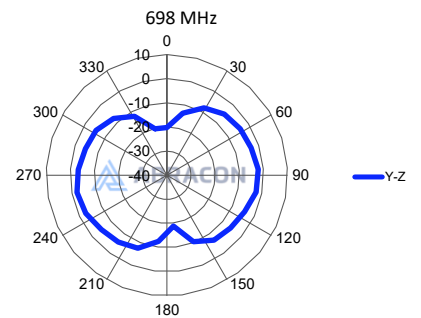

5G NR/ 4G/ LTE Ceramic Chip Antenna



ACR4006X

Request Samples



Check Inventory



40 x 6 x 5 mm

RoHS/RoHS II Compliant

MSL Level = N/A

960MHz

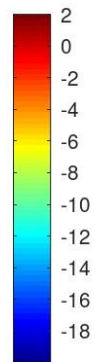
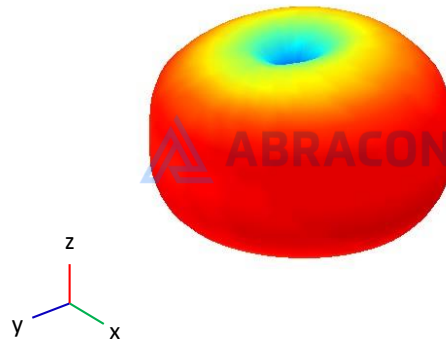
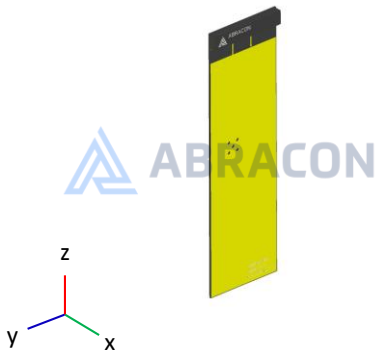

XY plane

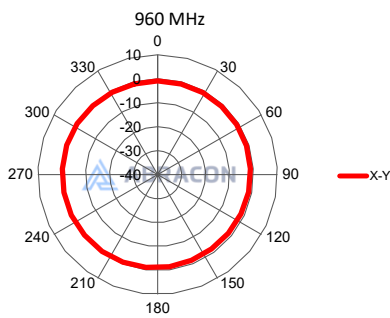

XZ plane

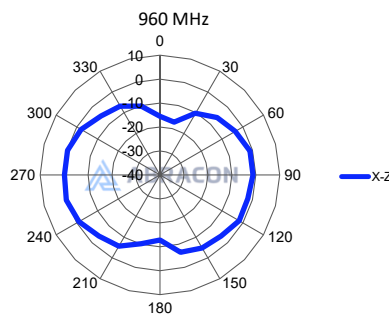

YZ plane

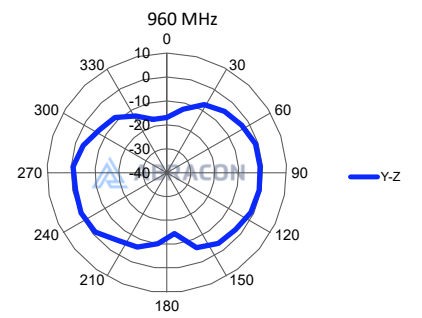

5G NR/ 4G/ LTE Ceramic Chip Antenna



ACR4006X

Request Samples



Check Inventory



40 x 6 x 5 mm

RoHS/RoHS II Compliant

MSL Level = N/A

1710MHz

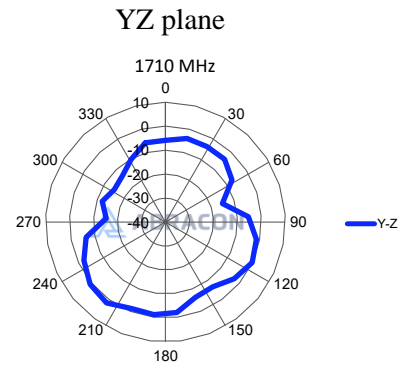
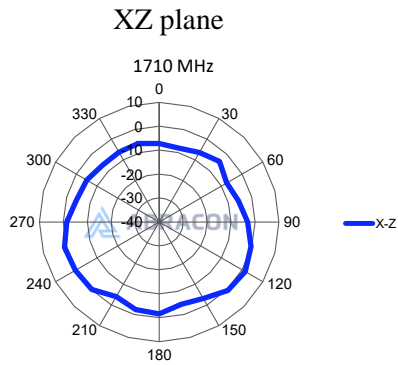
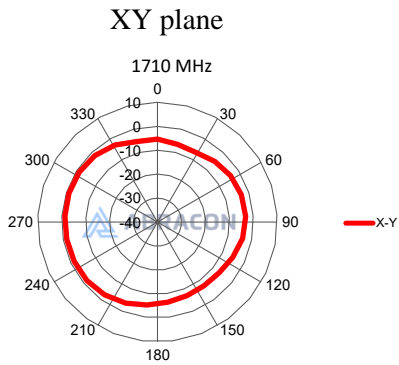
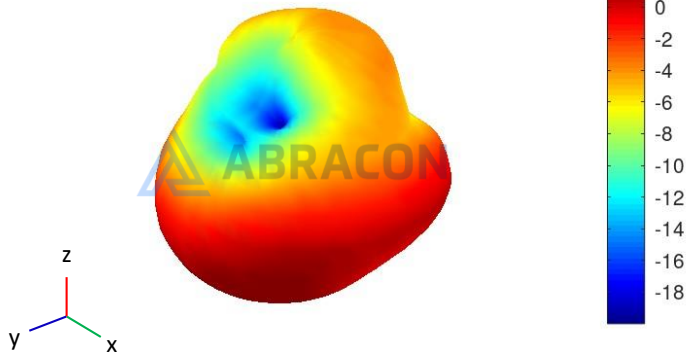
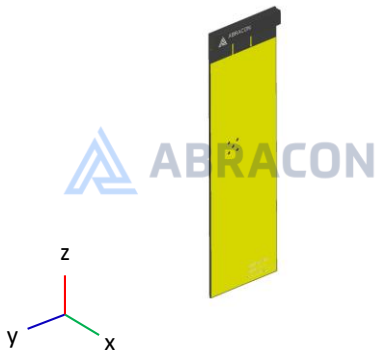

5G NR/ 4G/ LTE Ceramic Chip Antenna



ACR4006X

Request Samples



Check Inventory



40 x 6 x 5 mm

RoHS/RoHS II Compliant

MSL Level = N/A

1990MHz

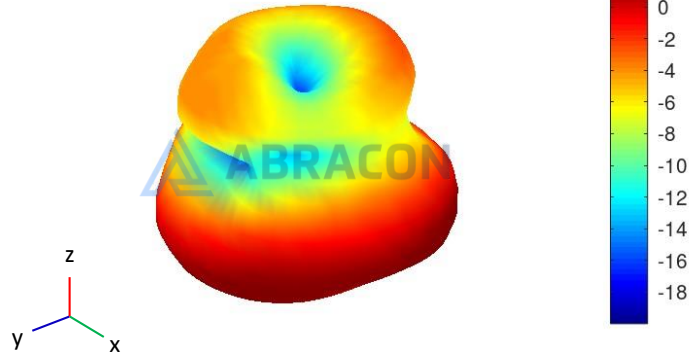

XY plane

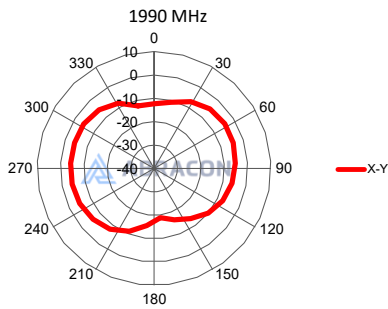

XZ plane

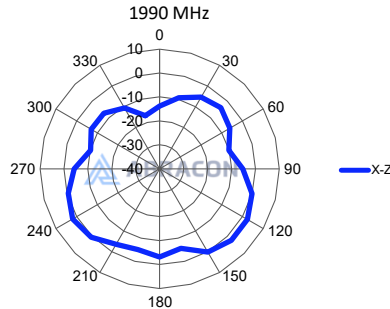

YZ plane

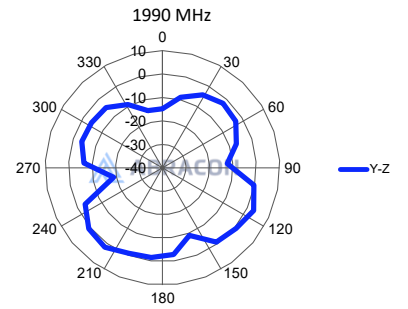

5G NR/ 4G/ LTE Ceramic Chip Antenna



ACR4006X

Request Samples



Check Inventory



40 x 6 x 5 mm

RoHS/RoHS II Compliant

MSL Level = N/A

2510MHz

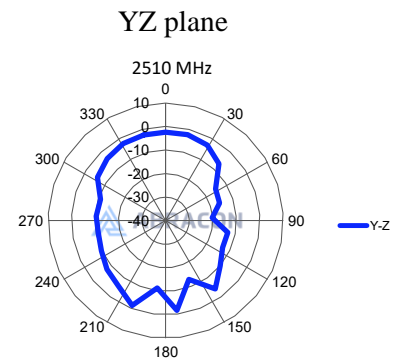
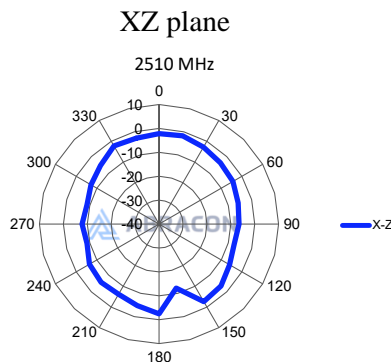
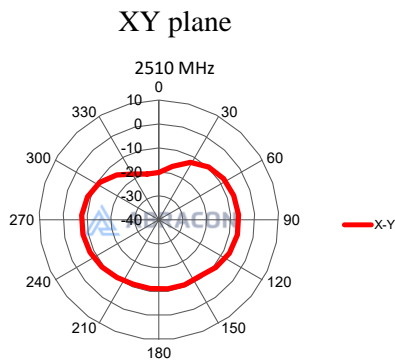
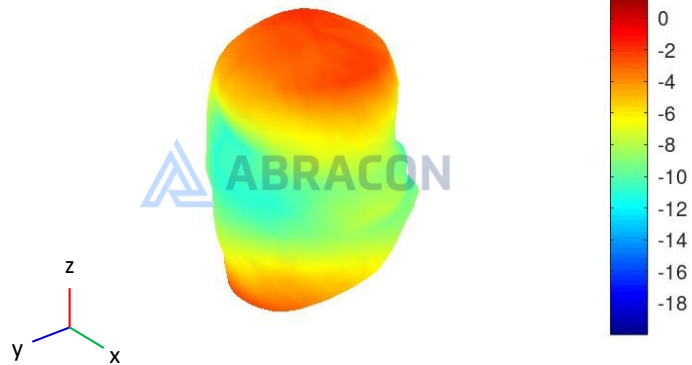

5G NR/ 4G/ LTE Ceramic Chip Antenna



ACR4006X

Request Samples



Check Inventory



40 x 6 x 5 mm

RoHS/RoHS II Compliant

MSL Level = N/A

2690MHz

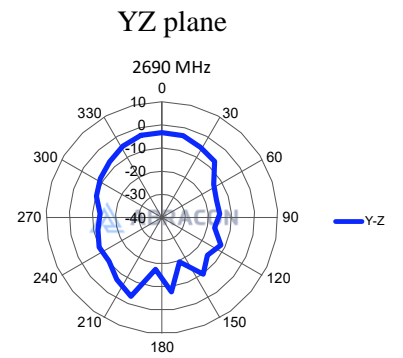
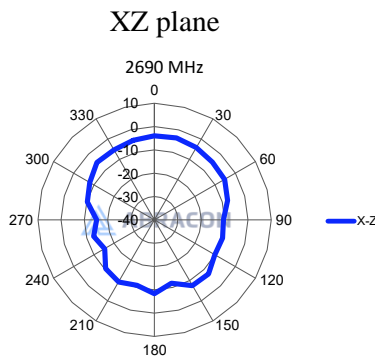
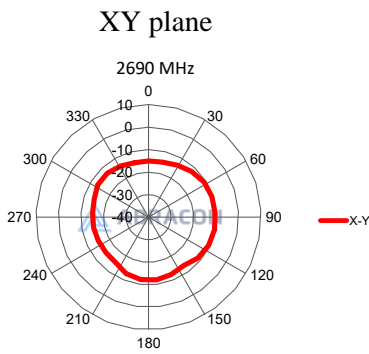
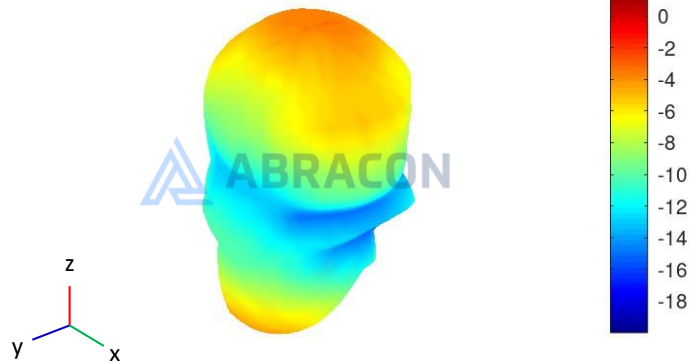
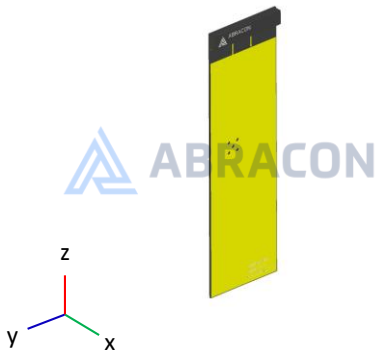

5G NR/ 4G/ LTE Ceramic Chip Antenna



ACR4006X

Request Samples



Check Inventory



40 x 6 x 5 mm
RoHS/RoHS II Compliant
MSL Level = N/A

3600MHz

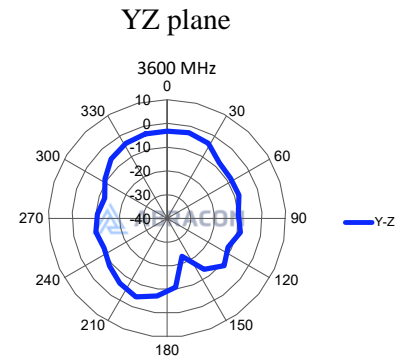
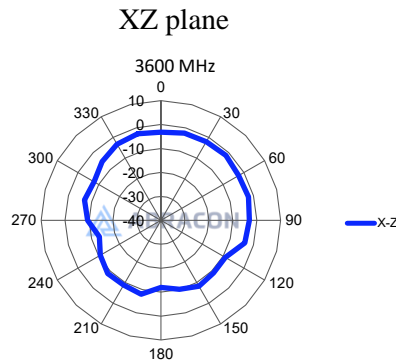
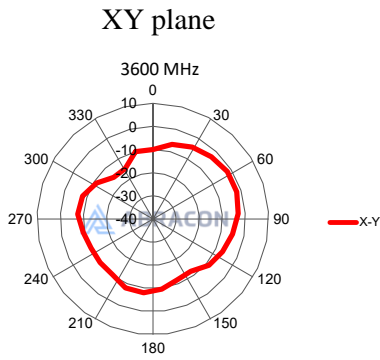
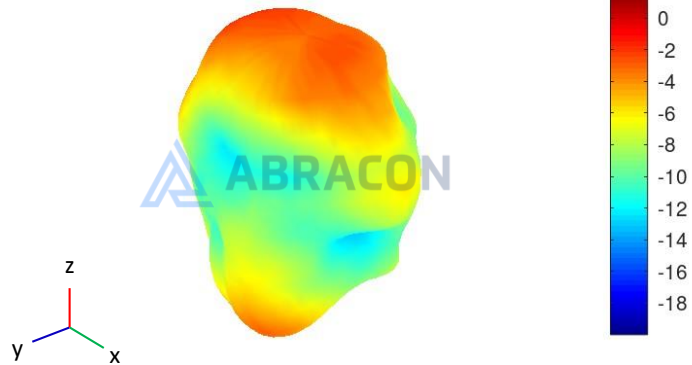

5G NR/ 4G/ LTE Ceramic Chip Antenna



ACR4006X

Request Samples



Check Inventory



40 x 6 x 5 mm

RoHS/RoHS II Compliant

MSL Level = N/A

5200MHz

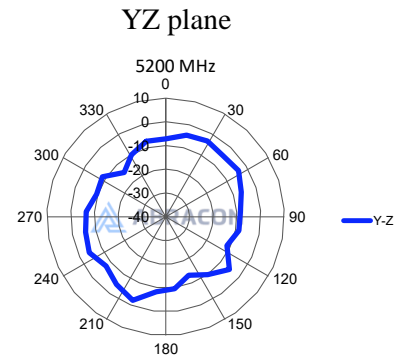
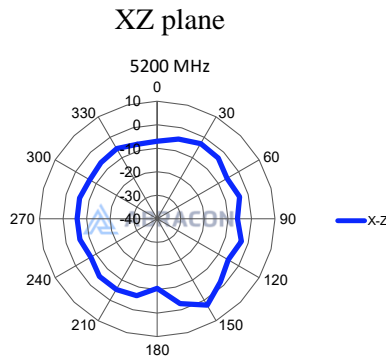
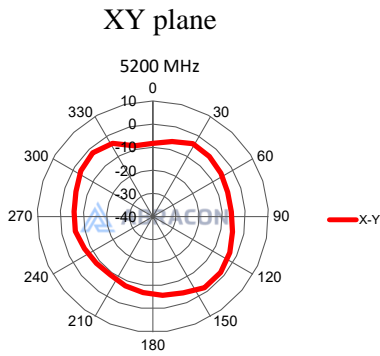
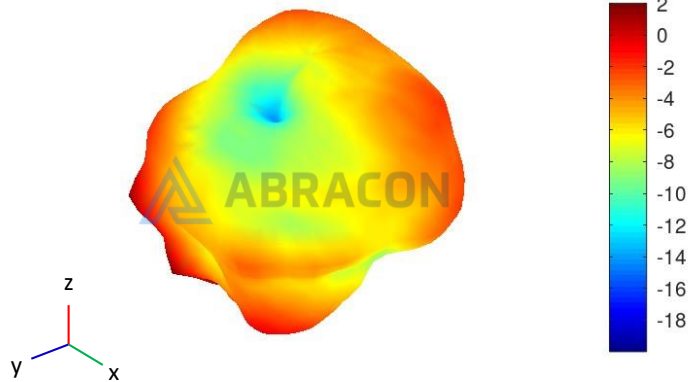
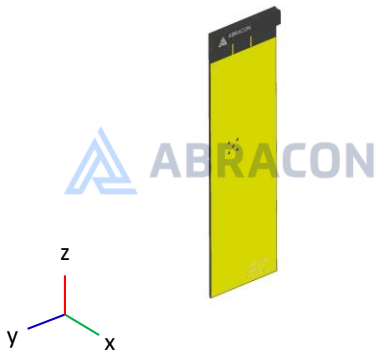

5G NR/ 4G/ LTE Ceramic Chip Antenna



ACR4006X

Request Samples



Check Inventory



40 x 6 x 5 mm

RoHS/RoHS II Compliant

MSL Level = N/A

5850MHz

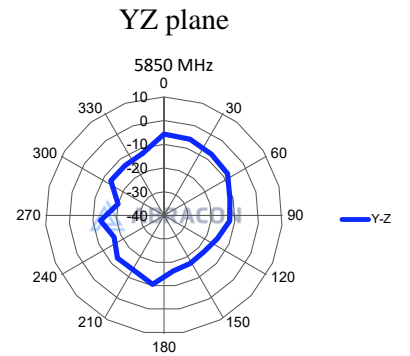
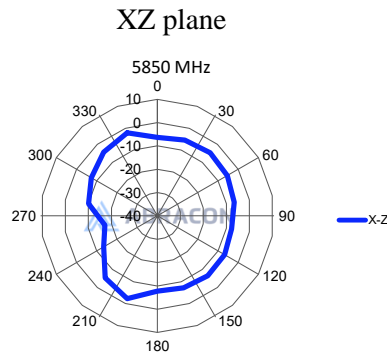
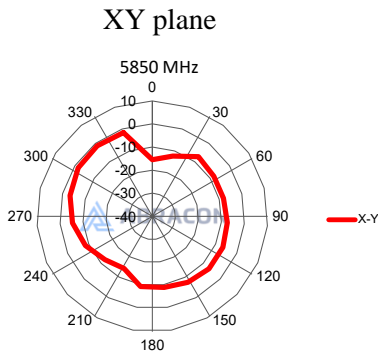
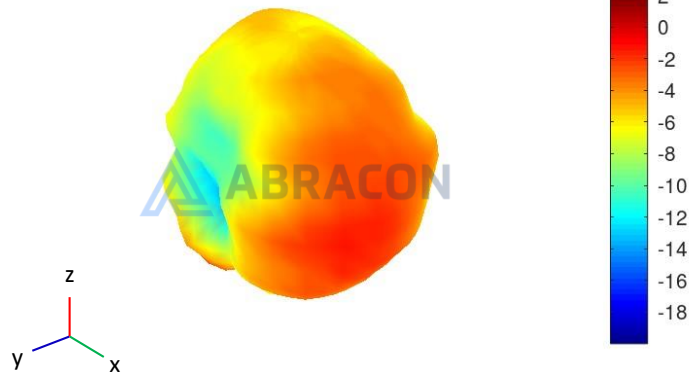
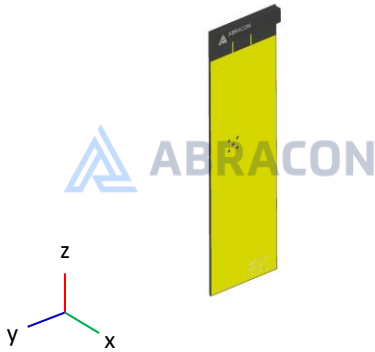

5G NR/ 4G/ LTE Ceramic Chip Antenna



ACR4006X

Request Samples



Check Inventory



40 x 6 x 5 mm

RoHS/RoHS II Compliant

MSL Level = N/A

Evaluation Board Dimensions

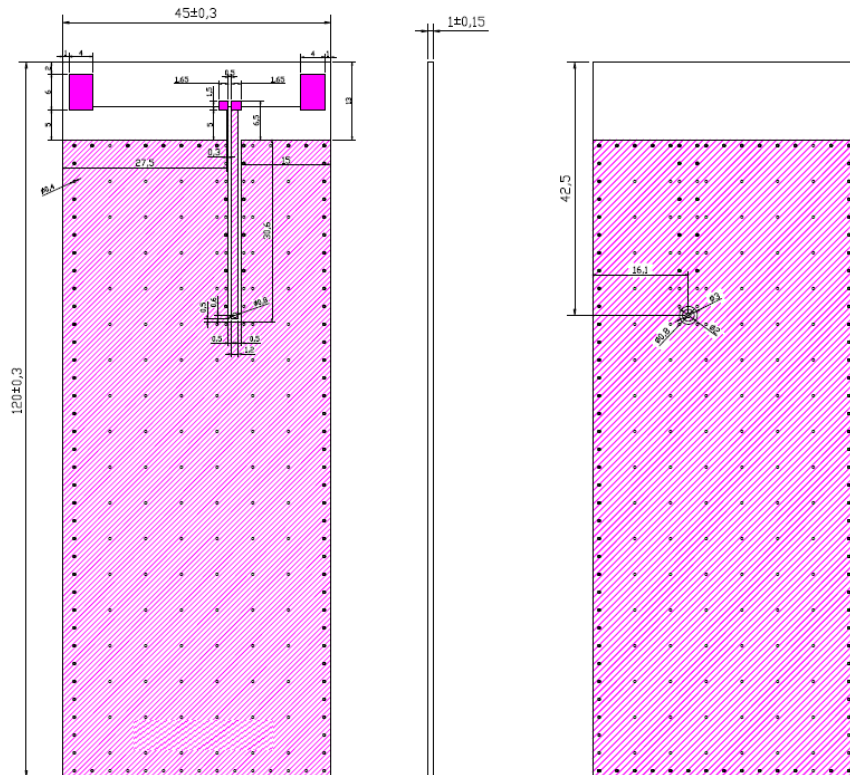

Unit: mm

5G NR/ 4G/ LTE Ceramic Chip Antenna



ACR4006X

Request Samples



Check Inventory



40 x 6 x 5 mm
RoHS/RoHS II Compliant
MSL Level = N/A

Recommended Layout Dimensions & Matching Circuit

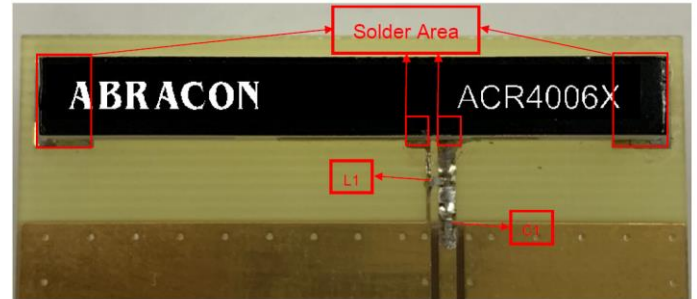
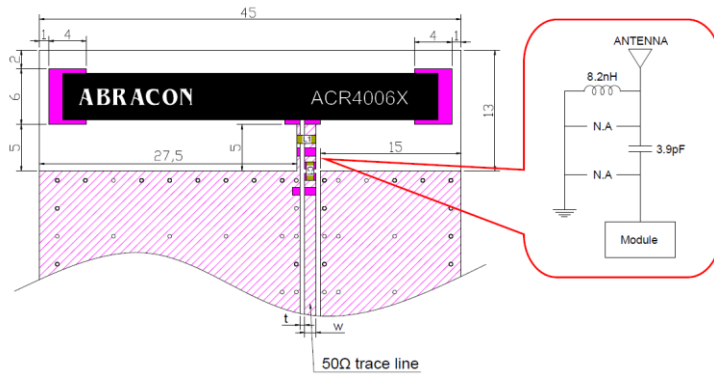

Circuit Symbol	Size	Description
L1	0402	8.2nH Inductor
C1	0402	3.9pF Capacitor

Transmission Line and Matching

Transmission line and matching

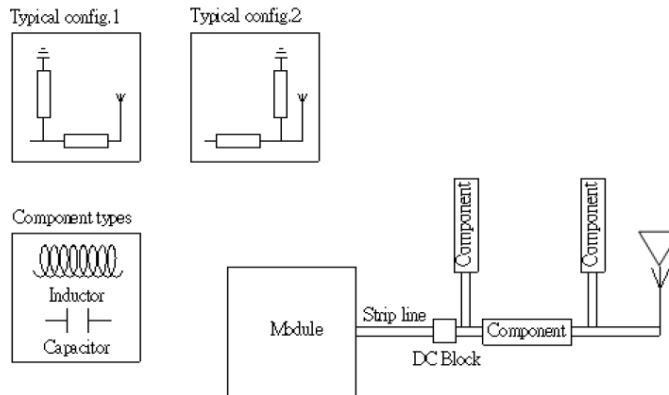

The matching network has to be individually designed using one, two or three components.

5G NR/ 4G/ LTE Ceramic Chip Antenna



ACR4006X

Request Samples



Check Inventory



40 x 6 x 5 mm

RoHS/RoHS II Compliant

MSL Level = N/A

Reflow Profile [JEDEC J-STD-020]

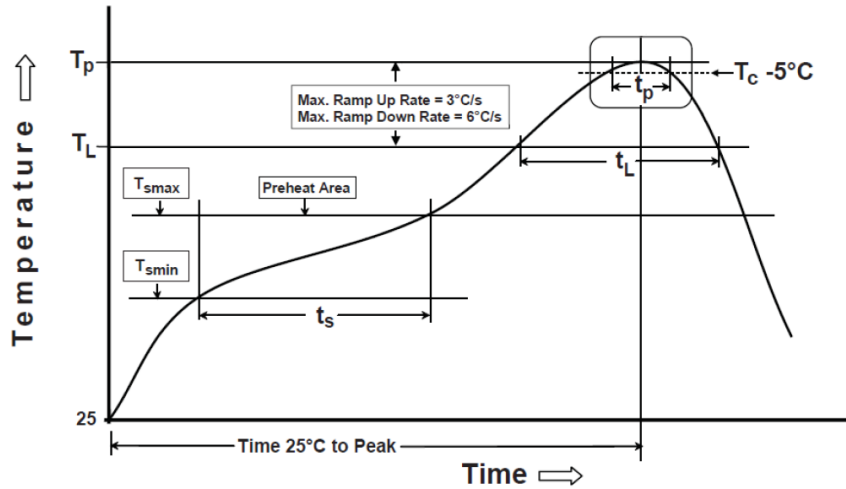

Soldering Condition: Soldering iron temperature 270 ± 10 °C. Apply preheating at 120°C for 2-3 minutes. Finish soldering each terminal within 3 seconds, if the soldering iron is over 270 ± 10 °C or 3 seconds, the component surface will peel or damage.

Phase	Profile features	Pb-Free Assembly (SnAgCu)
PREHEAT	-Temperature Min(T_{smin}) -Temperature Max(T_{smax}) -Time(t_s) form (T_{smin} to T_{smax})	150°C 200°C 60-120 seconds
RAMP-UP	Avg. Ramp-up Rate (T_{smax} to T_P)	3°C/second(max)
REFLOW	-Temperature(T_L) -Total Time above T_L (t_L)	217°C 30-100 seconds
PEAK	-Temperature(T_P) -Time(t_p)	260°C 20-30 second
RAMP-DOWN	Rate	6°C / second max.
Time from 25°C to Peak Temperature		8 minutes max.
Composition of solder paste		96.5Sn/3Ag/0.5Cu
Solder Paste Model		SHENMAO PF606-P26

5G NR/ 4G/ LTE Ceramic Chip Antenna



ACR4006X

Request Samples



Check Inventory



40 x 6 x 5 mm

RoHS/RoHS II Compliant

MSL Level = N/A

Packaging

1. Blister tape to IEC 286-3, polyester.
2. Number of pieces per tape: 450
3. Number of pieces per carton: 1350

Tape & Reel Dimension

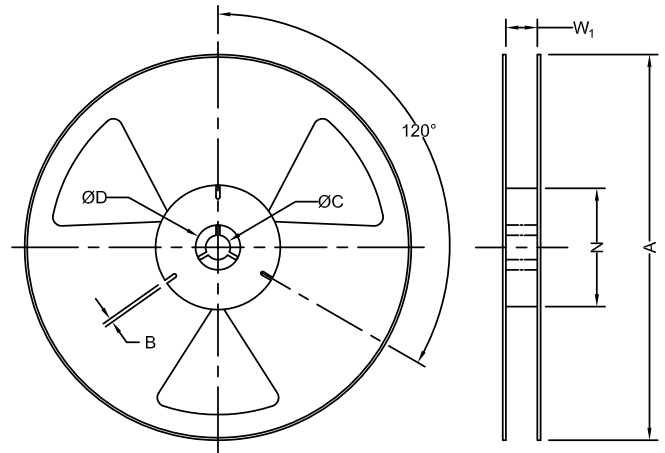
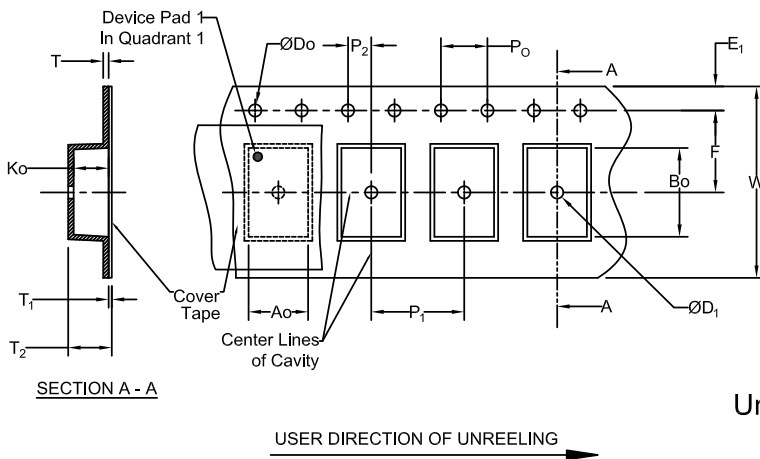
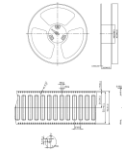

Unit: mm

Carrier Tape Specifications (mm)

Do	K ₀	E ₁	P ₀	P ₂	T	F	P ₁	W	Reel Qty
1.50 ± 0.1	5.40 ± 0.1	1.75 ± 0.1	4.0 ± 0.1	2.0 ± 0.10	0.4 ± 0.05	26.2 ± 0.10	12.0 ± 0.1	56.0 ± 0.3	450

Reel Specifications (mm)

A	W ₁	N	C
330 ± 1.0	56.0 ± 1.0	100 ± 1.0	13 ± 0.5

ATTENTION: Abracon LLC's products are COTS – Commercial-Off-The-Shelf products; suitable for Commercial, Industrial and, where designated, Automotive Applications. Abracon's products are not specifically designed for Military, Aviation, Aerospace, Life-dependent Medical applications or any application requiring high reliability where component failure could result in loss of life and/or property. For applications requiring high reliability and/or presenting an extreme operating environment, written consent and authorization from Abracon LLC is required. Please contact Abracon LLC for more information.



5101 Hidden Creek Ln Spicewood TX 78669
 Phone: 512-371-6159 | Fax: 512-351-8858
 For terms and conditions of sales, please visit:
www.abracon.com

REVISED: 10-01-20

ABRACON IS
 ISO9001-2015
 CERTIFIED