



ANT-5GW-SPS1 SERIES

Panel Mount 5G/LTE Antenna

The ANT-5GW-SPS1 series antenna is an external panel mount puck-style multiband antenna designed for 5G New Radio, LTE, and cellular IoT (LTE-M, NB-IoT) applications as well as 433 MHz, 868 MHz and 915 MHz LPWA applications.

The ANT-5GW-SPS1 provides a ground plane independent dipole antenna solution which mounts permanently to metallic and non-metallic surfaces.

The antenna terminates in an SMA plug (male pin) connector on 1 meter, 2 meter and 3 meter lengths of RG-174/U coaxial cable enabling an environmentally sealed enclosure and protection from tampering.

FEATURES

- Wide Bandwidth: 617 MHz to 960 MHz
- Performance at 617 MHz to 5925 MHz
 - VSWR: ≤ 3.0
 - Peak Gain: 5.4 dBi
 - Efficiency: 27%
- Performance at 3300 MHz to 4200 MHz
 - VSWR: ≤ 1.6
 - Peak Gain: 2.7 dBi
 - Efficiency: 32%
- Ground plane independent dipole antenna
- External mount, includes all hardware for installation including M12x1 hex nut, washer and optional boot
- SMA plug (male pin) gold plated connection
- IP65/IP67 ratable
- Impact resistant UV stabilized ABS radome material

APPLICATIONS

- Worldwide 5G/4G/3G/2G
- Cellular IoT: LTE-M (Cat-M1) and NB-IoT
- Private cellular networks
 - Citizens Broadband Radio Service (CBRS)
- 410 MHz LTE
- 4.9 GHz Public Safety
- Emerging 5G C-Band applications
- Emerging 5G 2.5 GHz EBS applications
- Low-power, wide-area (LPWA) applications
 - LoRaWAN®
 - Sigfox®
 - WiFi HaLow™ (802.11ah)
- Remote control, monitoring and sensing
- Internet of Things (IoT) devices
- ISM applications

ORDERING INFORMATION

Part Number	Description
ANT-5GW-SPS1-1	1 meter (39.37 in) 5G/LTE panel mount antenna with SMA plug (male pin) on RG-174/U coaxial cable and mounting hardware, including M12x1 hex nut, washer and rubber boot
ANT-5GW-SPS1-2	2 meters (78.74 in) 5G/LTE panel mount antenna with SMA plug (male pin) on RG-174/U coaxial cable and mounting hardware, including M12x1 hex nut, washer and rubber boot
ANT-5GW-SPS1-3	3 meters (118.11 in) 5G/LTE panel mount antenna with SMA plug (male pin) on RG-174/U coaxial cable and mounting hardware, including M12x1 hex nut, washer and rubber boot

Available from Linx Technologies and select distributors and representatives.

TABLE 1. ELECTRICAL SPECIFICATIONS

Bands	Frequency Range	VSWR (max.)	Peak Gain (dBi)	Avg. Gain (dBi)	Efficiency (%)
71	410 MHz to 426 MHz	1.8	-0.1	-5.1	33
12, 13, 14, 17, 28, 29, 44, 67, 68, 85, n83	450 MHz to 470 MHz	2.9	-4.2	-12.8	8
5, 8, 12, 13, 14, 17, 18, 19, 20, 26, 27, 28, 29, 44, 67, 69, 81, 82, 83, 89	617 MHz to 960 MHz	3.0	5.4	-6.9	27
1, 2, 3, 4, 9, 10, 25, 33, 34, 35, 36, 37, 39, 65, 66, 80, 84, 86, 95	1695 MHz to 2200 MHz	2.2	3.8	-10.4	26
30, 40	2300 MHz to 2400 MHz	1.3	4.2	-3.1	52
7, 41	2496 MHz to 2690 MHz	1.6	2.7	-5.2	33
22, 42, 43, 48, 49, 52, n77, n78	3300 MHz to 4200 MHz	1.6	2.7	-5.7	32
n79	4400 MHz to 5925 MHz	1.6	5.1	-4.6	39

Electrical specifications and plots measured with a 300 mm x 300 mm (11.8 in x 11.8 in) ground plane.

TABLE 2. MECHANICAL SPECIFICATIONS

Parameter	Value
Operating Temperature Range	-40 °C to +70 °C
Weight	63.4 g (2.24 oz)
Dimensions	23.3 mm x Ø54.7 mm (0.92 in x Ø2.15 in)
Connection	SMA Plug (male pin)
Cable	1 meter (39.37 in), 2 meters (78.74 in) and 3 meters (118.11 in) of RG-174/U coaxial cable
IP Rating	IP65/IP67 Ratable

PACKAGING INFORMATION

The ANT-5GWWS3-SMA antenna is individually sealed in a clear plastic bag. Plastic bags are sealed in a larger plastic bag in quantities of 50 pcs. Distribution channels may offer alternative packaging options.

PRODUCT DIMENSIONS

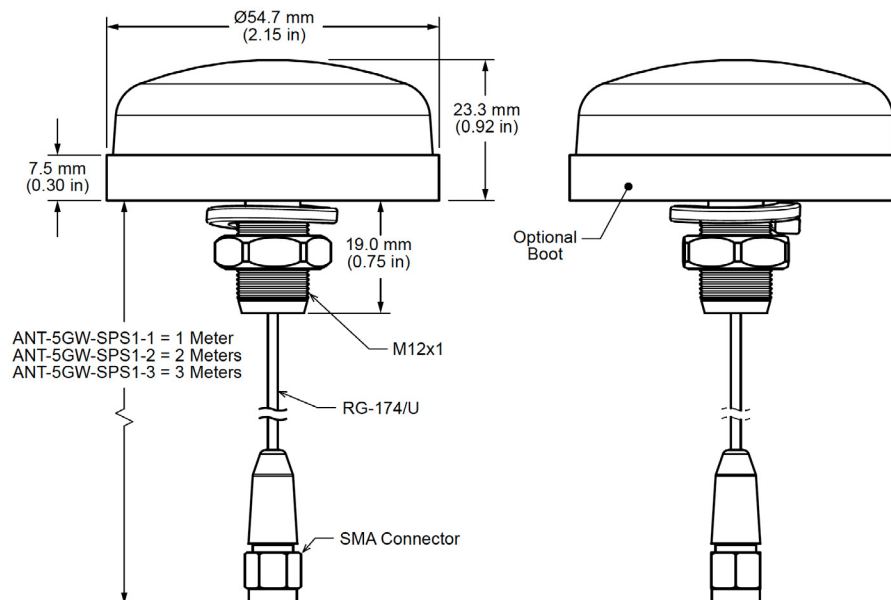

Figure 1. ANT-5GW-SPS1 Series Dimensions

VSWR

Figure 2 provides the voltage standing wave ratio (VSWR) across the antenna bandwidth. VSWR describes the power reflected from the antenna back to the radio. A lower VSWR value indicates better antenna performance at a given frequency. Reflected power is also shown on the right-side vertical axis as a gauge of the percentage of transmitter power reflected back from the antenna.

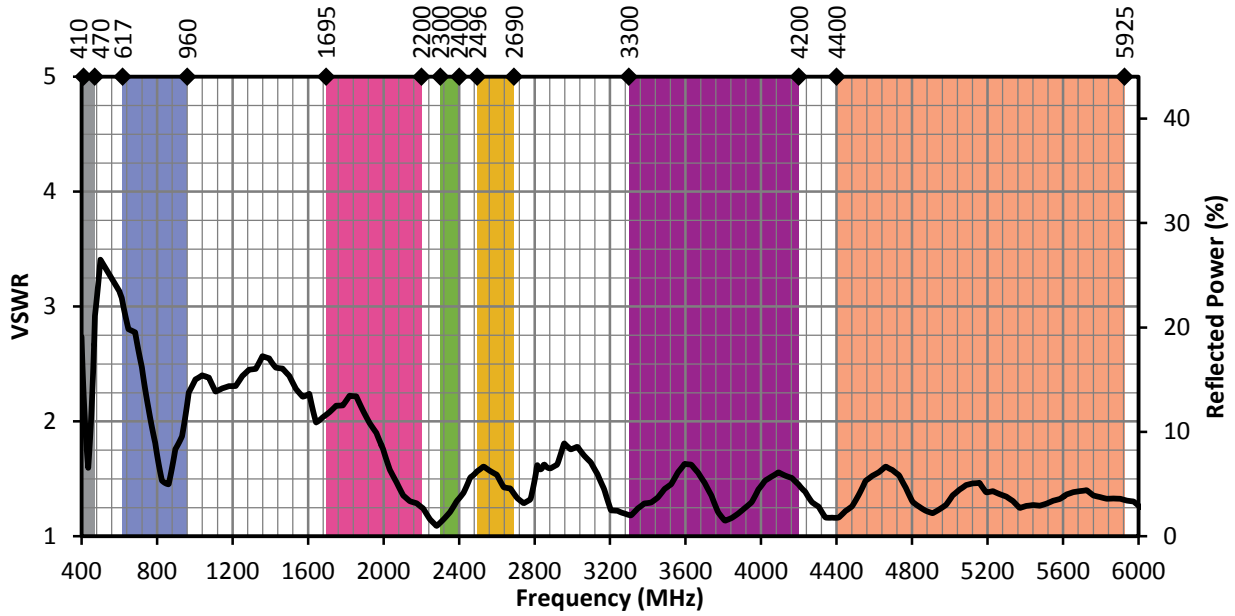

Figure 2. ANT-5GW-SPS1 VSWR

RETURN LOSS

Return loss (Figure 3), represents the loss in power at the antenna due to reflected signals. Like VSWR, a lower return loss value indicates better antenna performance at a given frequency.

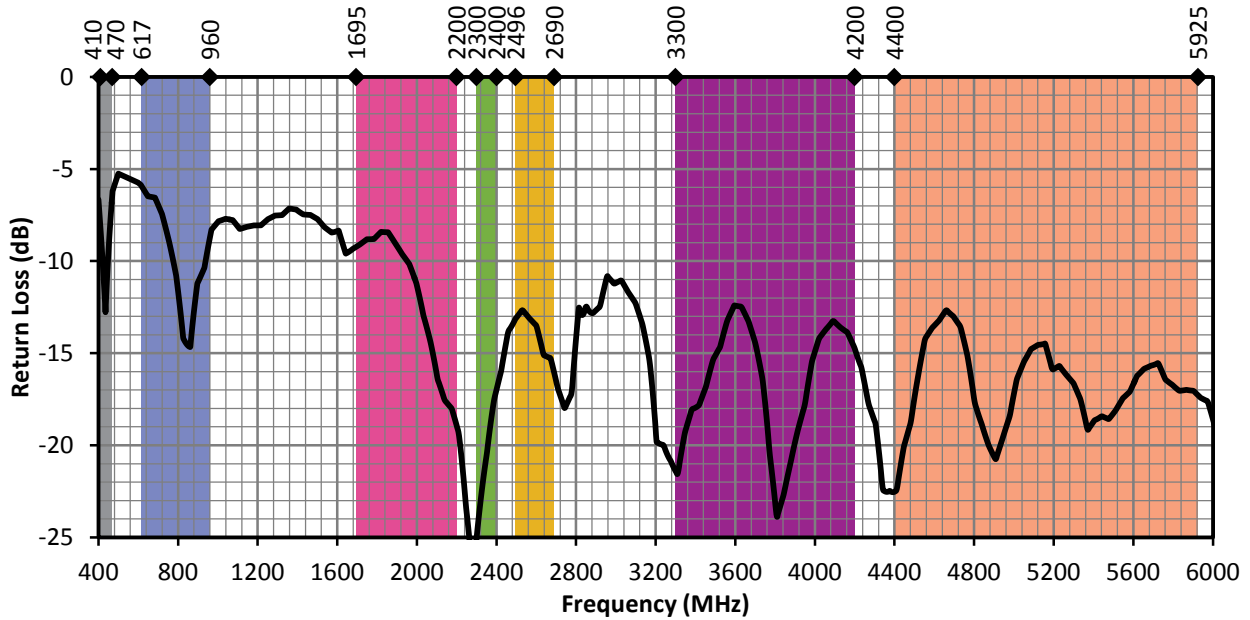

Figure 3. ANT-5GW-SPS1 Return Loss

PEAK GAIN

The peak gain across the antenna bandwidth is shown in Figure 4. Peak gain represents the maximum antenna input power concentration across 3-dimensional space, and therefore peak performance at a given frequency, but does not consider any directionality in the gain pattern.

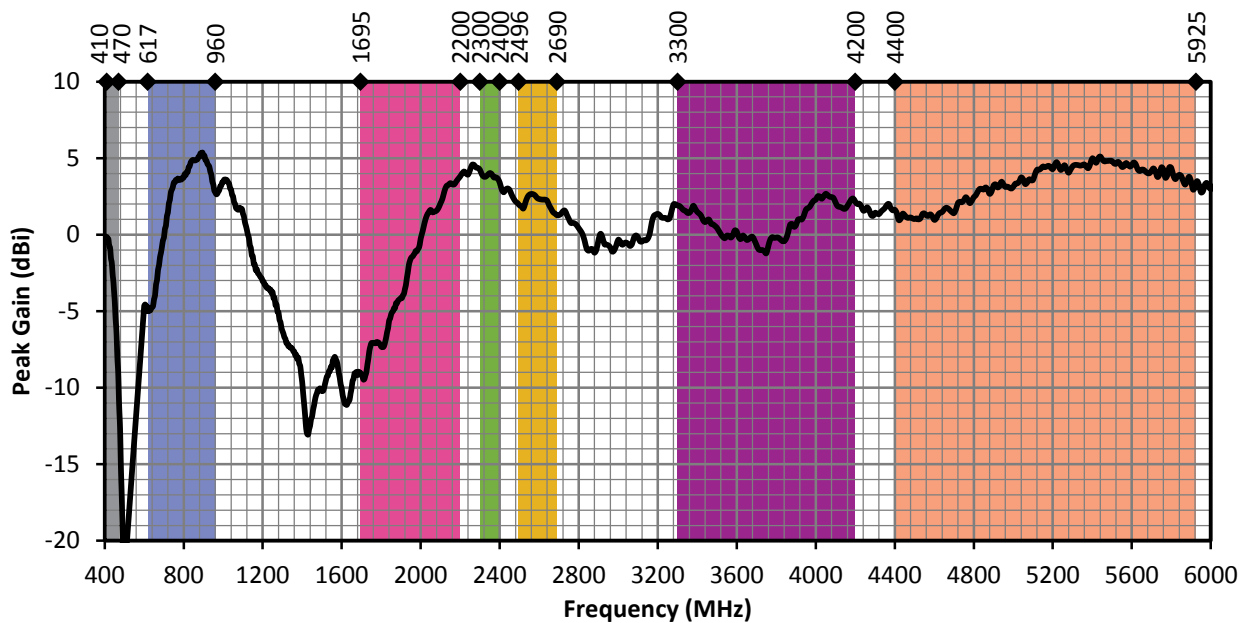

Figure 4. ANT-5GW-SPS1 Peak Gain

AVERAGE GAIN

Average gain (Figure 5), is the average of all antenna gain in 3-dimensional space at each frequency, providing an indication of overall performance without expressing antenna directionality.

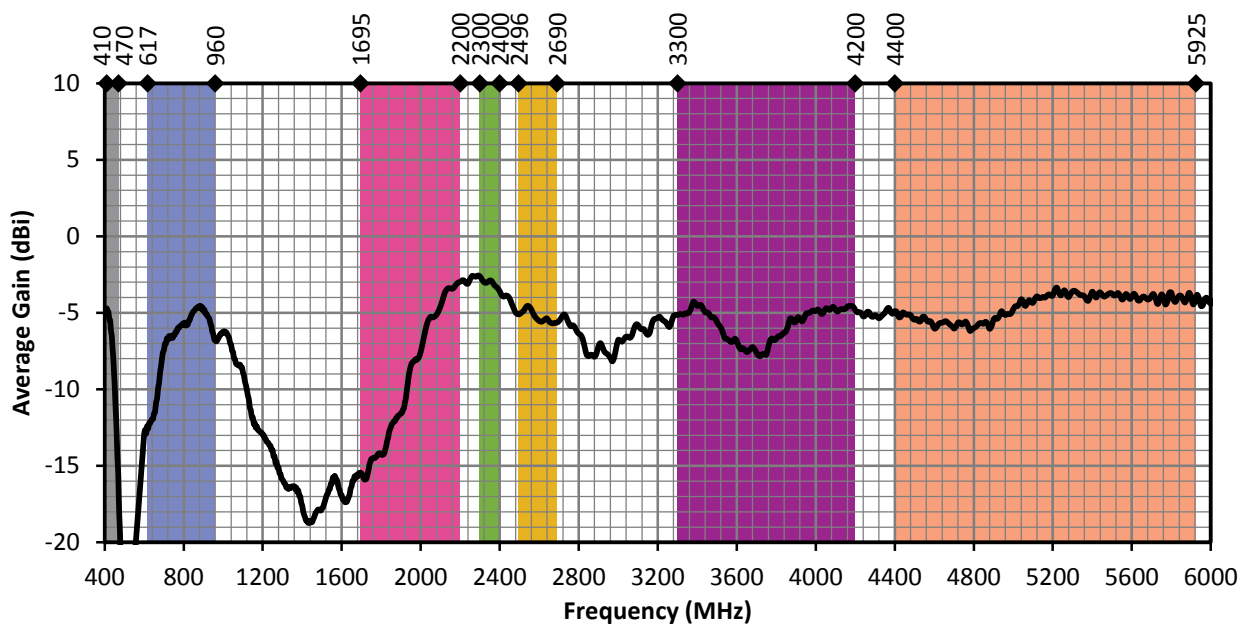

Figure 5. ANT-5GW-SPS1 Antenna Average GainStraight

RADIATION EFFICIENCY

Radiation efficiency (Figure 6), shows the ratio of power delivered to the antenna relative to the power radiated at the antenna, expressed as a percentage, where a higher percentage indicates better performance at a given frequency.

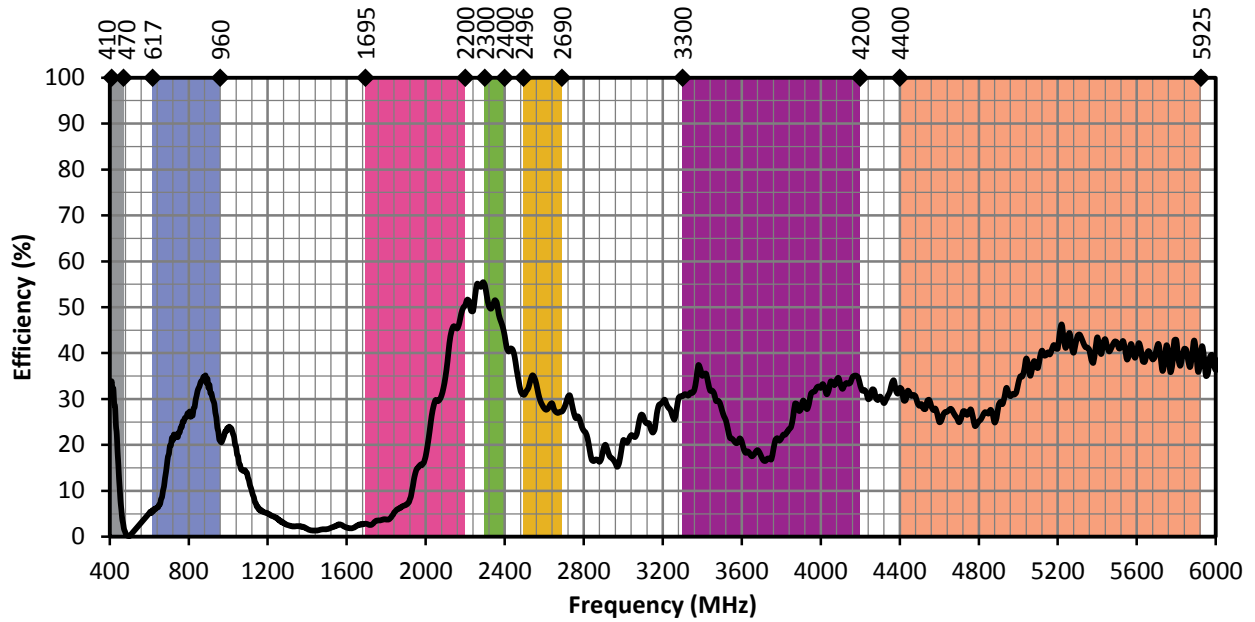

Figure 6. ANT-5GW-SPS1 Antenna Efficiency

RADIATION PATTERNS

Radiation patterns provide information about the directionality and 3-dimensional gain performance of the antenna by plotting gain at specific frequencies in three orthogonal planes. Antenna radiation patterns for a straight orientation are shown in Figure 9 using polar plots covering 360 degrees. The antenna graphic at the top of the page provides reference to the plane of the column of plots below it. Note: when viewed with typical PDF viewing software, zooming into radiation patterns is possible to reveal fine detail.

RADIATION PATTERNS - STRAIGHT



XZ-Plane Gain



YZ-Plane Gain

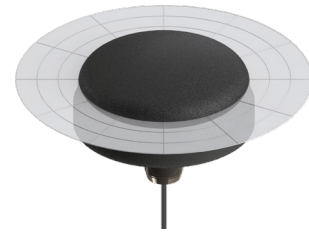

XY-Plane Gain

410 MHz TO 426 MHz (420 MHz)

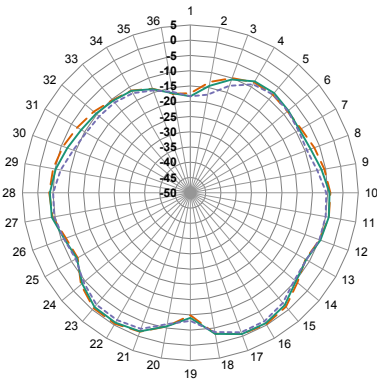

XZ-Plane Gain

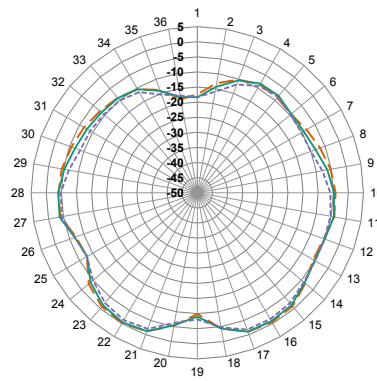

YZ-Plane Gain

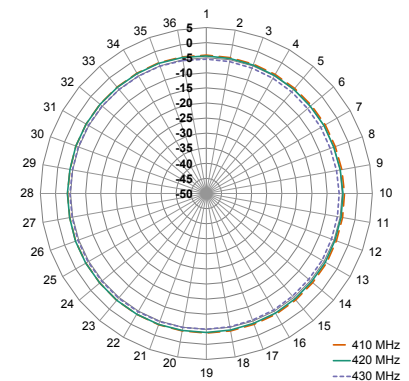

XY-Plane Gain

450 MHz TO 470 MHz (460 MHz)

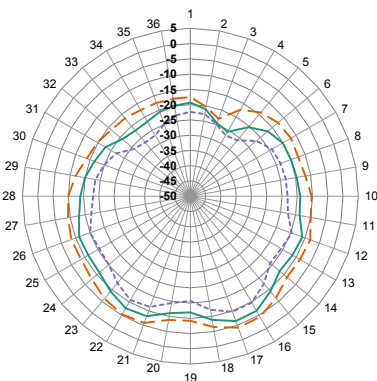

XZ-Plane Gain

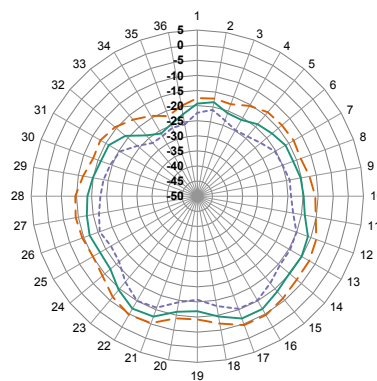

YZ-Plane Gain

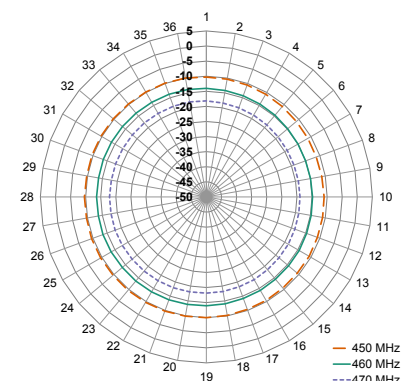

XY-Plane Gain

RADIATION PATTERNS - STRAIGHT

617 MHz TO 960 MHz (790 MHz)

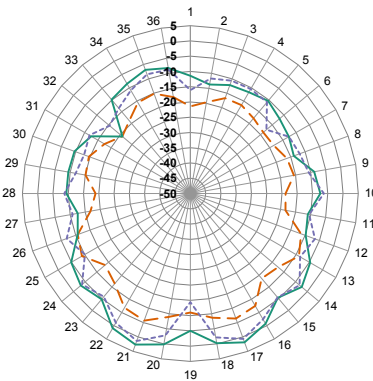

XZ-Plane Gain

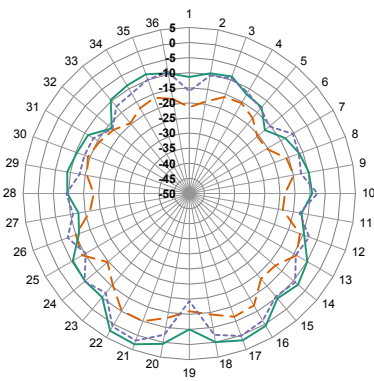

YZ-Plane Gain

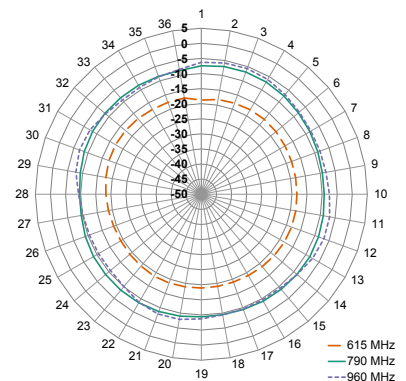

XY-Plane Gain

— 615 MHz
— 790 MHz
- - 960 MHz

1695 MHz TO 2200 MHz (1950 MHz)

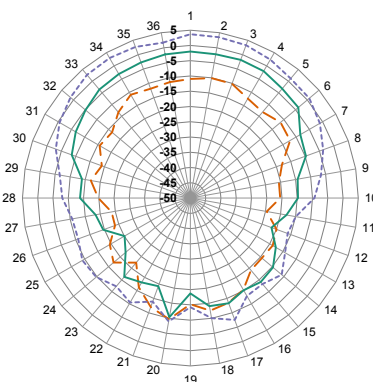

XZ-Plane Gain

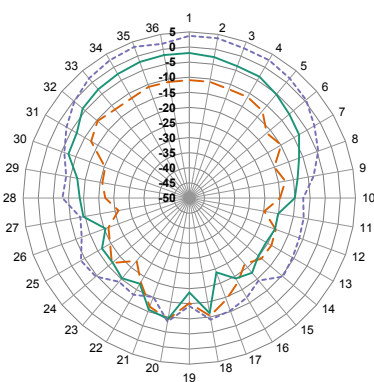

YZ-Plane Gain

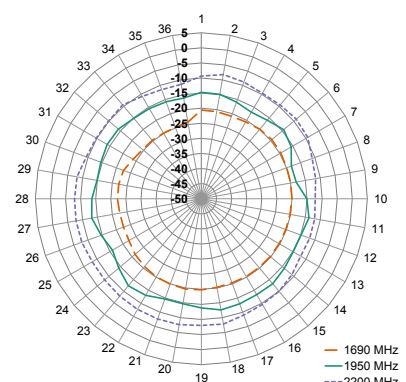

XY-Plane Gain

— 1690 MHz
— 1950 MHz
- - 2200 MHz

2300 MHz TO 2400 MHz (2350 MHz)

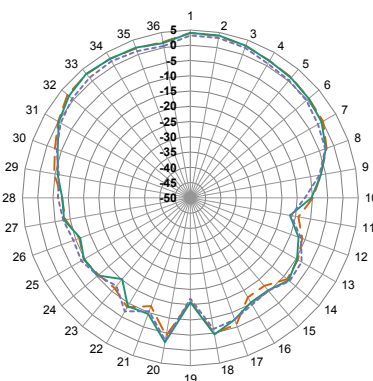

XZ-Plane Gain

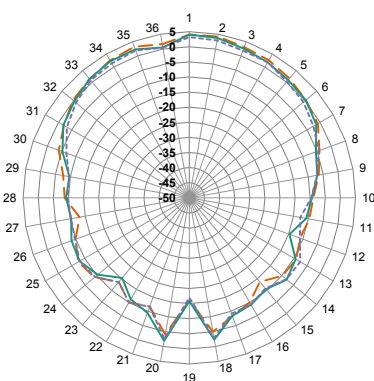

YZ-Plane Gain

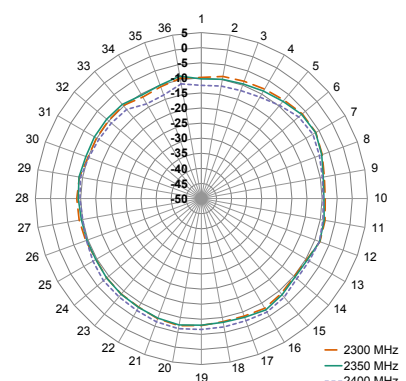

XY-Plane Gain

— 2300 MHz
— 2350 MHz
- - 2400 MHz

RADIATION PATTERNS - STRAIGHT

2496 MHz TO 2690 MHz (2590 MHz)

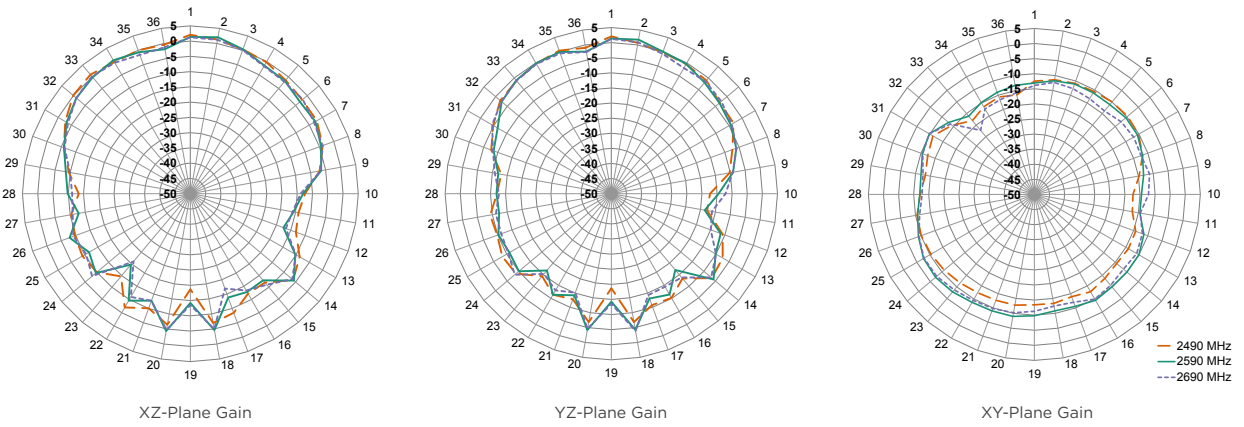

3300 MHz TO 4200 MHz (3750 MHz)

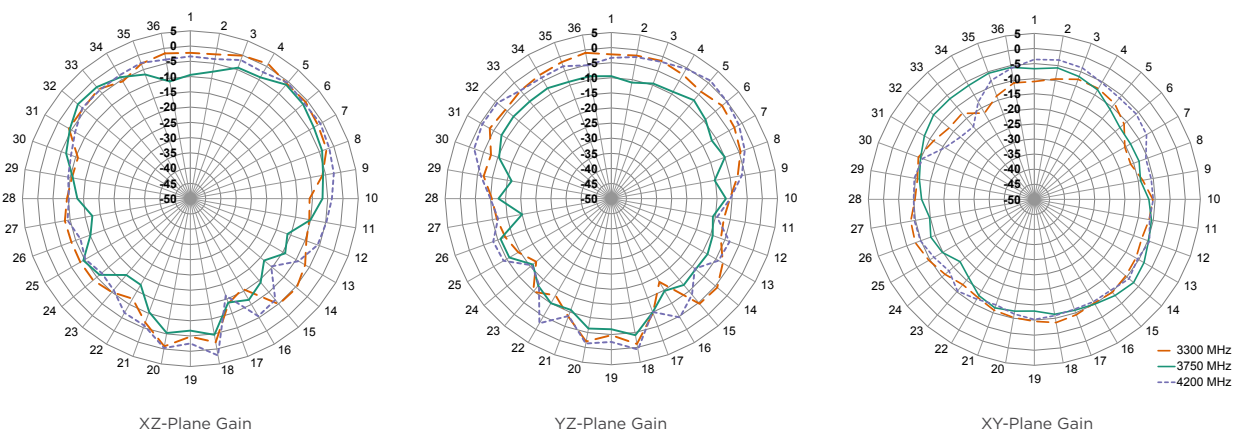

4400 MHz TO 5925 MHz (5170 MHz)

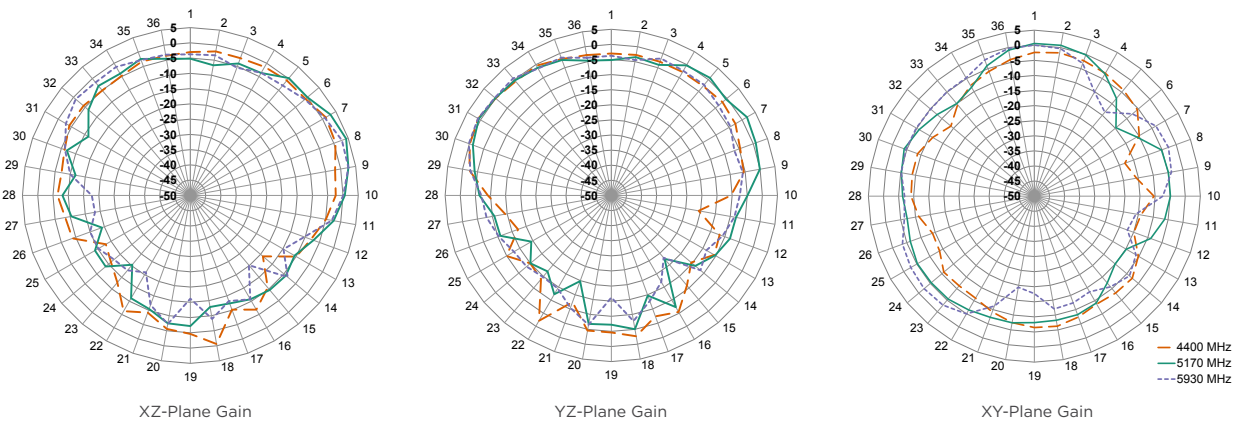

Figure 7. ANT-5GW-SPS1 Radiation Patterns

LPWA: LORAWAN® AND SIGFOX®

LoRaWAN and Sigfox LPWA technologies operate within several of the frequencies supported by the ANT-5GW-SPS1 series antennas. Notably, LoRaWAN operates at the frequency bands shown in Table 3. Sigfox operates at different frequencies determined by country (Table 4).

TABLE 3. LORAWAN® CHANNEL PLAN

Frequency Band	LoRaWAN Channel Plan
779 MHz to 787 MHz	CN779-787
865 MHz to 867 MHz	IN765-867
868 MHz to 873 MHz	EU863-870
902 MHz to 928 MHz	US902-928, AS923
915 MHz to 928 MHz	AU915-928
917 MHz to 923.5 MHz	KR920-923

TABLE 4. SIGFOX® FREQUENCIES BY COUNTRY/REGION

Center Frequency	Select Countries/Regions
868 MHz	Europe
902 MHz	USA, Mexico, Brazil
920 MHz	Australia
923 MHz	Japan

ANTENNA MOUNTING

The ANT-5GW-SPS1 series antenna is an externally mounted multiband antenna that can be permanently installed onto metallic and non-metallic surfaces up to 3.9 mm (0.15 in) thick when used with the provided boot, and up to 4.2 mm (0.17 in) without the boot. Use of the boot is optional, and is intended to reduce the potential for marring of the mounting surface.

The antenna terminates in a M12x1 threaded shaft and is provided with a washer and hex nut. The mounting hole dimensions are shown in Figure 8.

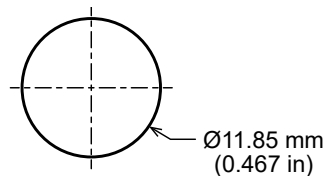

Figure 8. ANT-5GW-SPS1 Mounting Hole Dimensions Patterns

PACKAGING INFORMATION

The ANT-5GW-SPS1 series antenna is individually placed in a polyethylene bag. 50 pcs. are sealed in larger polyethylene bags. Larger quantities are shipped in cartons of 100 pcs. Carton size = 320 mm x 250 mm x 230 mm (12.60 in x 9.84 in x 9.10 in). Distribution channels may offer alternative packaging options.

TE TECHNICAL SUPPORT CENTER

USA:	+1 (800) 522-6752
Canada:	+1 (905) 475-6222
Mexico:	+52 (0) 55-1106-0800
Latin/S. America:	+54 (0) 11-4733-2200
Germany:	+49 (0) 6251-133-1999
UK:	+44 (0) 800-267666
France:	+33 (0) 1-3420-8686
Netherlands:	+31 (0) 73-6246-999
China:	+86 (0) 400-820-6015

te.com

TE Connectivity, TE, TE connectivity (logo), Linx and Linx Technologies are trademarks owned or licensed by the TE Connectivity Ltd. family of companies. All other logos, products and/or company names referred to herein might be trademarks of their respective owners.

The information given herein, including drawings, illustrations and schematics which are intended for illustration purposes only, is believed to be reliable. However, TE Connectivity makes no warranties as to its accuracy or completeness and disclaims any liability in connection with its use. TE Connectivity's obligations shall only be as set forth in TE Connectivity's Standard Terms and Conditions of Sale for this product and in no case will TE Connectivity be liable for any incidental, indirect or consequential damages arising out of the sale, resale, use or misuse of the product. Users of TE Connectivity products should make their own evaluation to determine the suitability of each such product for the specific application.

TE Connectivity warrants to the original end user customer of its products that its products are free from defects in material and workmanship. Subject to conditions and limitations TE Connectivity will, at its option, either repair or replace any part of its products that prove defective because of improper workmanship or materials. This limited warranty is in force for the useful lifetime of the original end product into which the TE Connectivity product is installed. Useful lifetime of the original end product may vary but is not warranted to exceed one (1) year from the original date of the end product purchase.

©2022 TE Connectivity. All Rights Reserved.

10/22 Original