

SF1219K

2338.75 MHz
SAW Filter

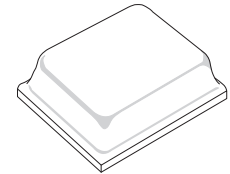

SM1411-5H

- RF SAW Filter with Single-ended input and Balanced Output
- 1.4 x 1.1 x 0.6 mm Surface-Mount Case
- $Z_S = 50 \text{ ohm}$, $Z_L = 100 \text{ ohm}$
- Complies with Directive 2002/95/EC (RoHS)
- Moisture Sensitivity Level: 3
- AEC-Q200 Qualified

Absolute Maximum Ratings

Rating	Value	Units
Maximum Input Power	+15	dBm
Maximum DC Voltage Between any Two Terminals	3	V
Operating Temperature Range	-40 to +85	°C
Storage Temperature Range in Tape and Reel	-40 to +85	°C
Maximum Soldering Profile	265 °C for 10 s	

Electrical Characteristics

Characteristic	Sym	Notes	Min	Typ	Max	Units
Center Frequency	f_C		2338.75			MHz
Maximum Insertion Loss, 2332.5 to 2345.0 MHz	IL_{MAX}			2.6	3.2	dB
Amplitude Ripple, 2332.5 to 2345.0 MHz				0.2	1.0	dB _{P-P}
Group Delay Ripple, 2332.5 to 2345.0 MHz				6.5		ns _{P-P}
Group Delay, 2338.75 MHz				12		ns
Return Loss, 2332.5 to 2345.0 MHz			6.5	9.6		dB
Source Impedance, Single Ended				50		Ω
Load Impedance, Balanced				100		Ω
Rejection:						
DC to 2224 MHz			35	41		dB
2453 to 2600 MHz			35	40		
2600 to 3000 MHz			40	44		
3000 to 6000 MHz			35	44		

Case Style	1.4 x 1.1 x 0.7 mm
Lid Symbolization: 3, <u>YW</u> (Y = Year, W = Week)	

Connection	Terminal
Input	1
Output	3, 4
Ground	2, 5

 **CAUTION: Electrostatic Sensitive Device. Observe precautions for handling.**

NOTES:

1. The design, manufacturing process, and specifications of this device are subject to change.
2. US or International patents may apply.
3. RoHS compliant from the first date of manufacture.

Filter Performance without Input Matching

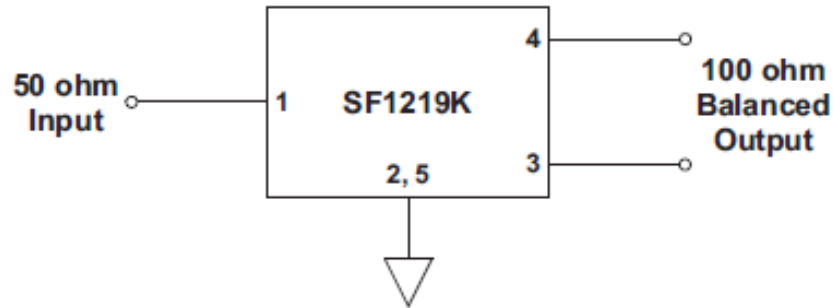

Filter Amplitude Response, 300 kHz to 6000 MHz:

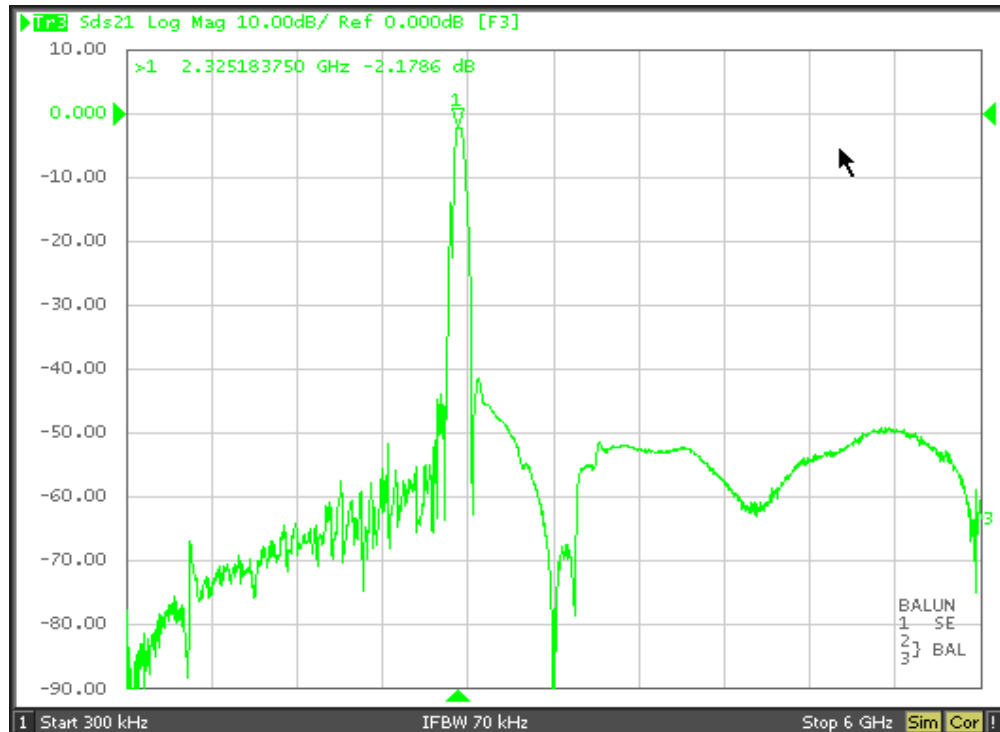

Filter Amplitude Response, 2113 to 2563 MHz:

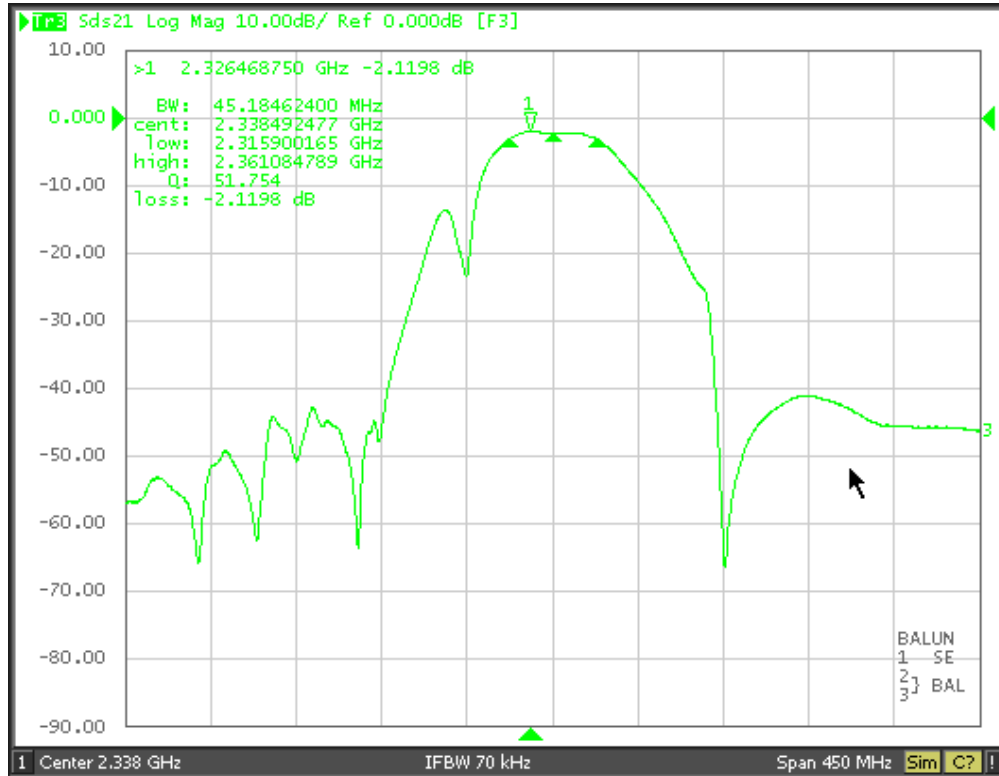

Passband Amplitude and Return Loss:

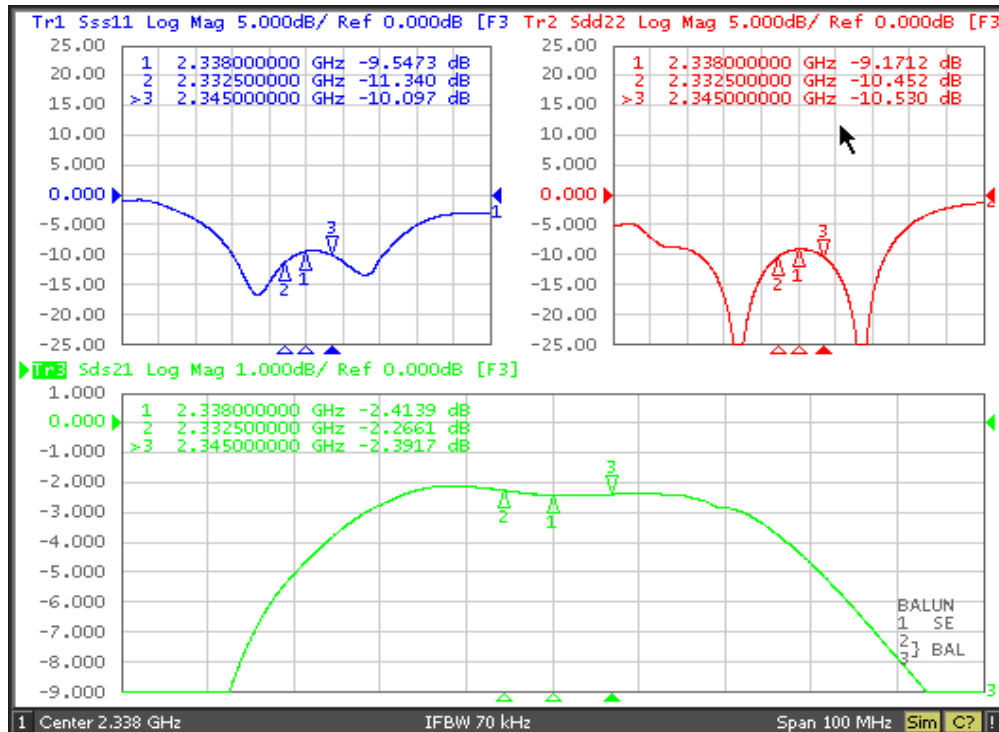

Passband Group Delay:

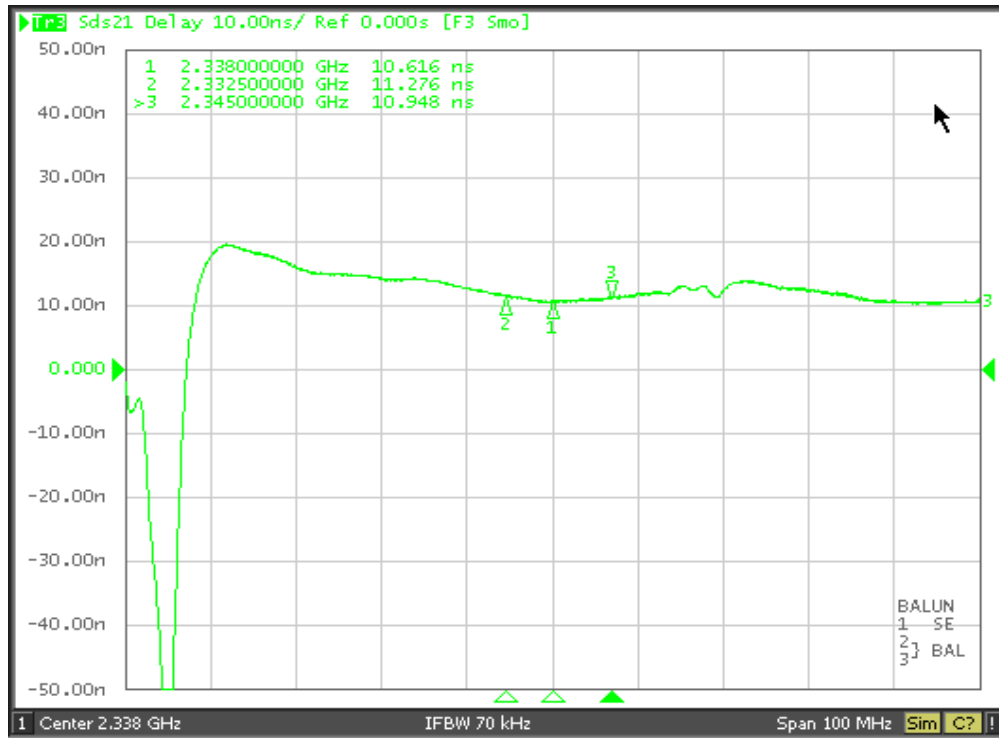

Passband Smith Chart Plots:

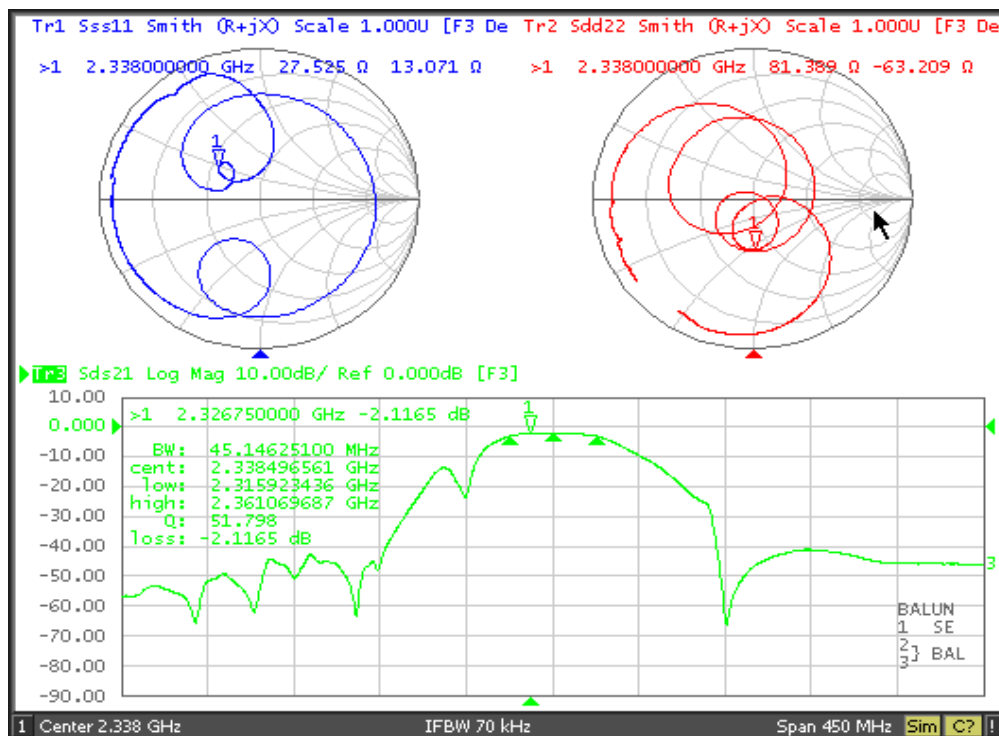

Filter Performance with Input Matching

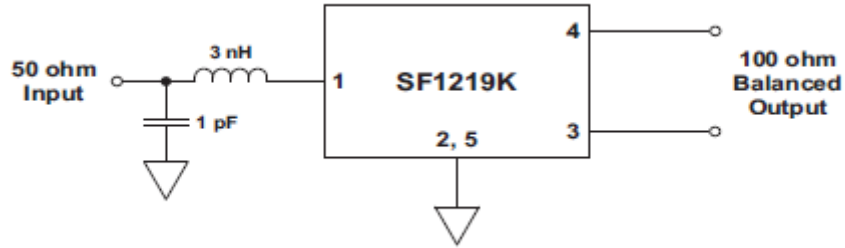

Filter Amplitude Response, 300 kHz to 6000 MHz:

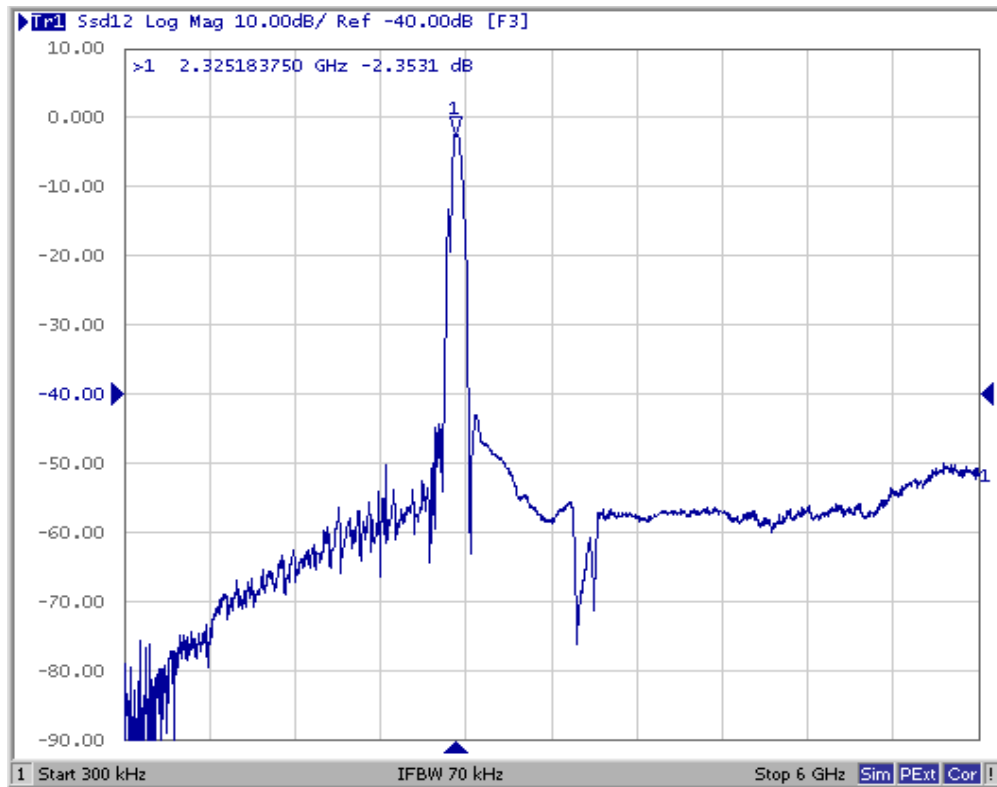

Filter Amplitude Response, 2113 to 2563 MHz:

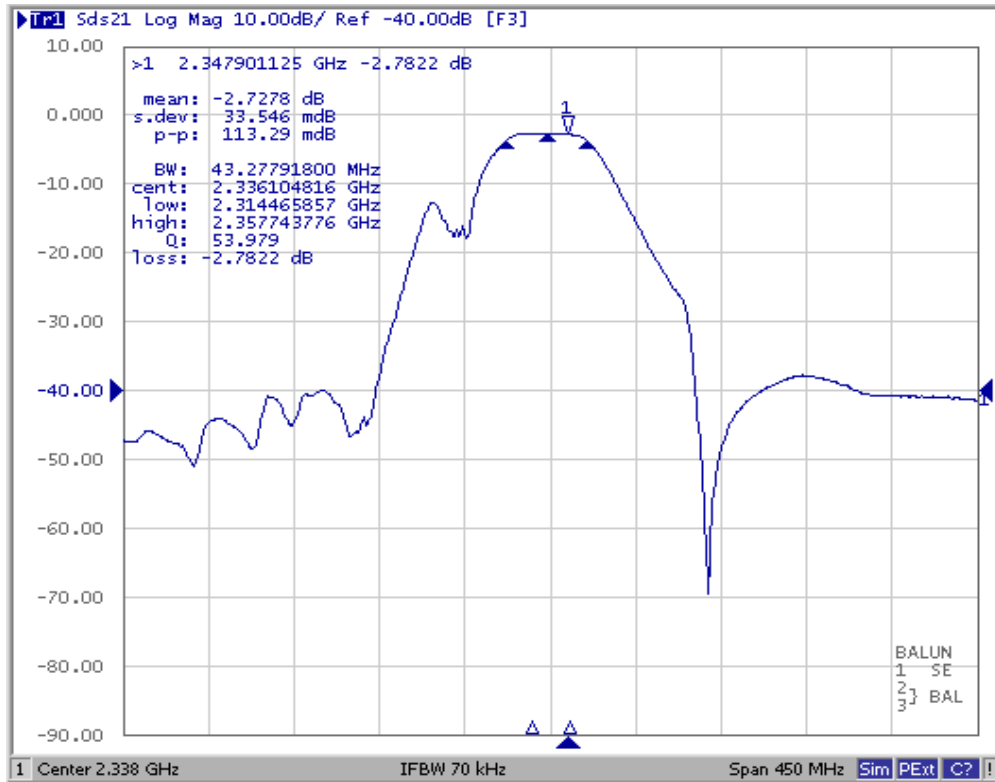

Passband Amplitude and Group Delay Response:

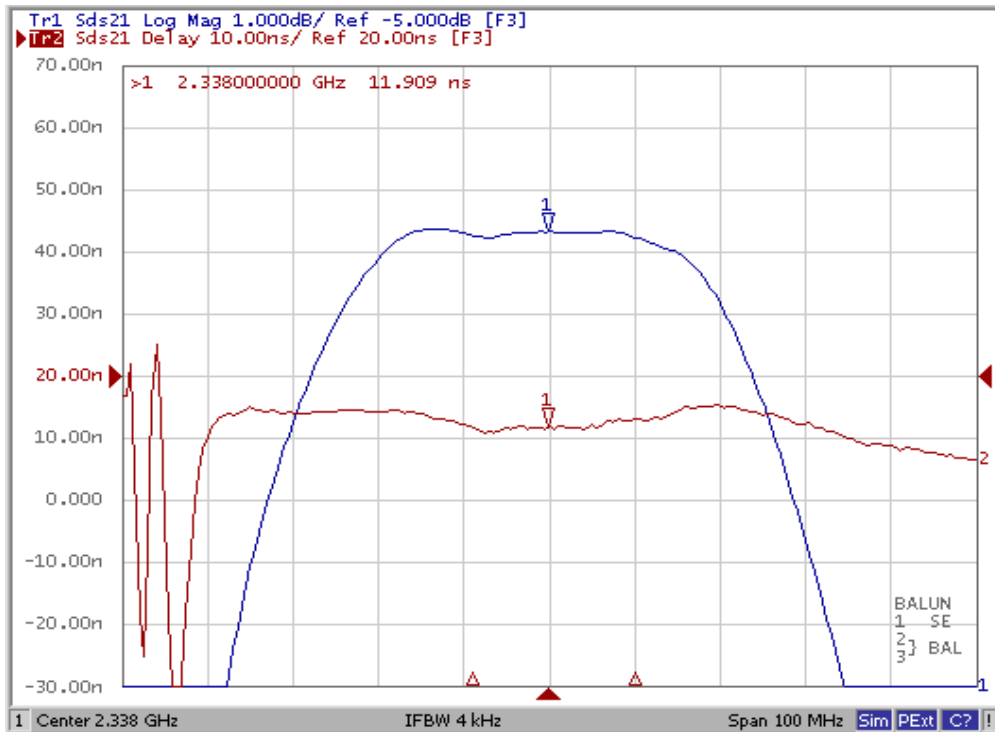

S₁₁ Smith Chart Plot:

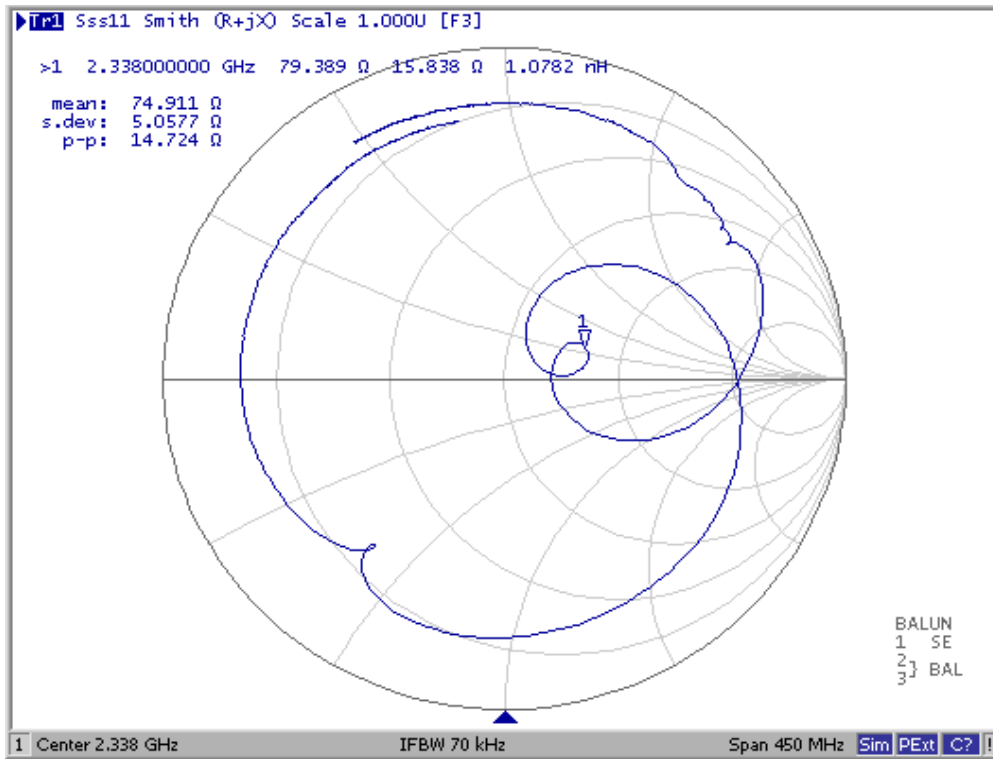

S₂₂ Smith Chart Plot:

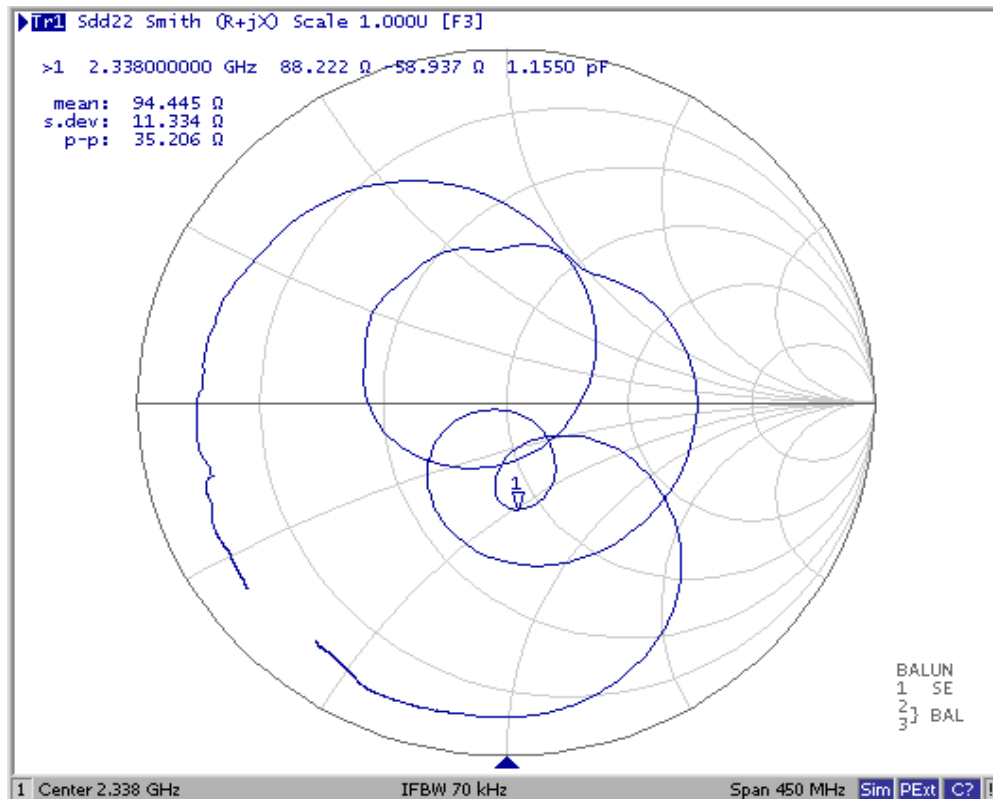

SM1411-5H 5 Terminal 1.4 X 1.1 mm Surface-mount Case Drawing

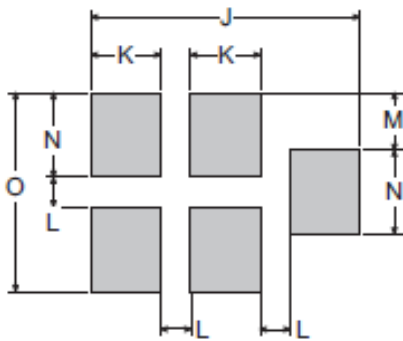
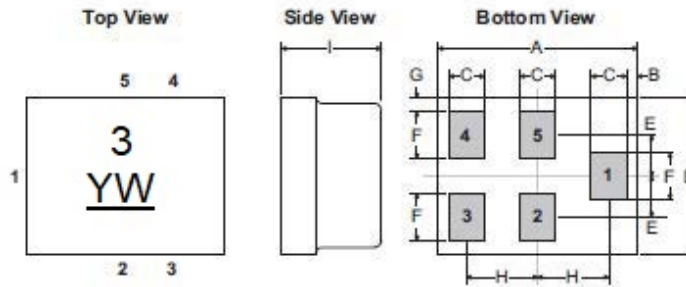

PCB Footprint

Dimension	mm			Inches		
	Min	Nom	Max	Min	Nom	Max
A	1.3500	1.4000	1.4500	0.0531	0.0551	0.0571
B	-	0.0750	-	-	0.0030	-
C	0.1700	0.250	0.3300	0.0067	0.0098	0.0130
D	1.0500	1.1000	1.1500	0.0413	0.0433	0.0453
E	-	0.2875	-	-	0.0113	-
F	0.2450	0.3250	0.4050	0.0096	0.0128	0.0159
G	-	0.100	-	-	0.0039	-
H	-	0.5000	-	-	0.0197	-
I	0.6000	0.6500	0.700	0.0236	0.0256	0.0276
J	-	1.3500	-	-	0.0531	-
K	-	0.3500	-	-	0.0138	-
L	-	0.1500	-	-	0.0059	-
M	-	0.2875	-	-	0.0113	-
N	-	0.4250	-	-	0.0167	-
O	-	1.0000	-	-	0.0394	-

Materials	
Solder Pad Plating	0.3 to 1.0 μm Gold over 1.27 to 8.89 μm Nickel
Lid Plating	2.0 to 3.0 μm Nickel
Body	Al_2O_3 Ceramic

Tape and Reel Detail

Tape and Reel Standard per ANSI/EIA-481

Reel Count:
7" = 3000
13" = 10,000

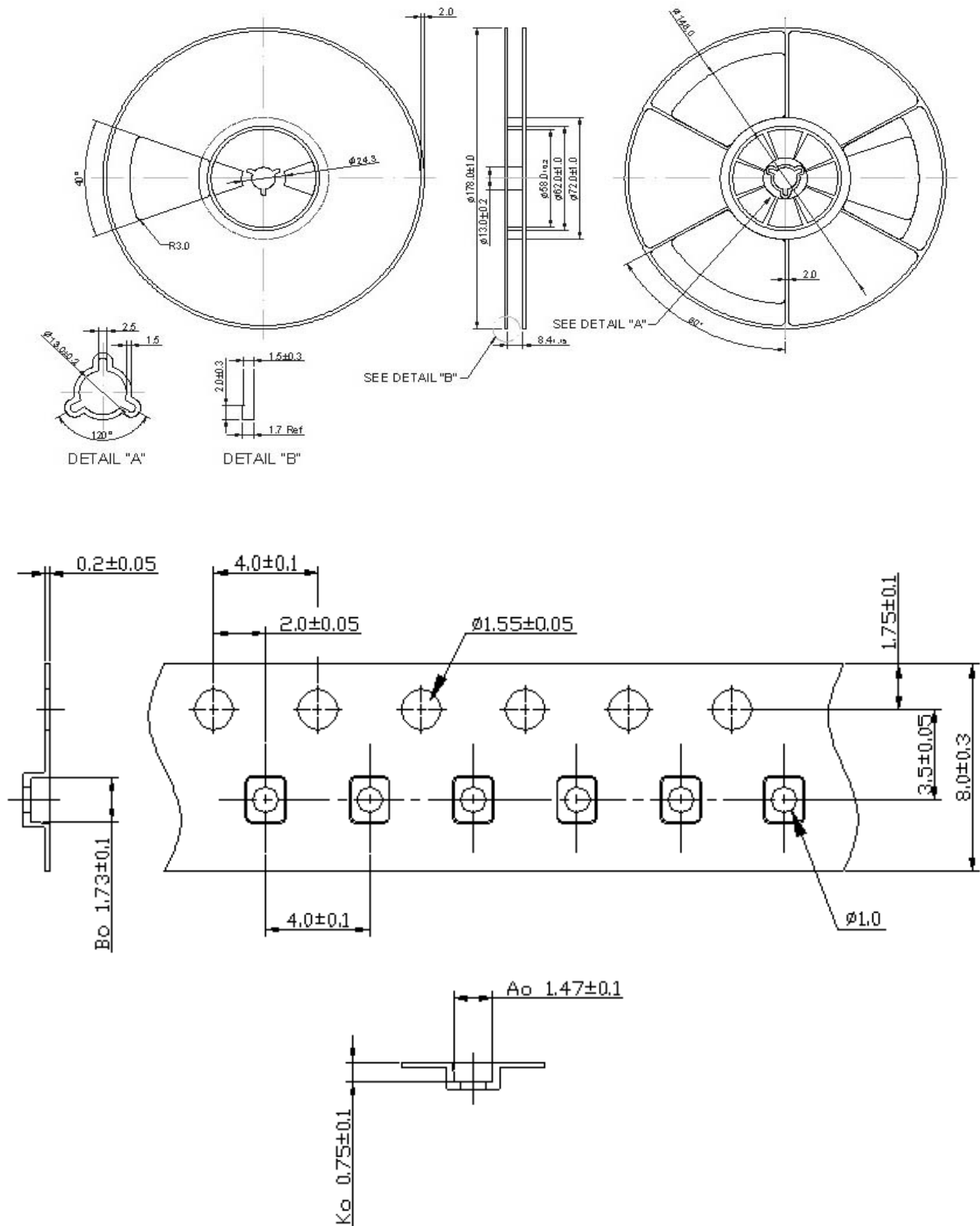

Recommended Reflow Profile

1. Preheating shall be fixed at 150~180°C for 60~90 seconds.
2. Ascending time to preheating temperature 150°C shall be 30 seconds min.
3. Heating shall be fixed at 220°C for 50~80 seconds and at 260°C +0/-5°C peak (10 seconds).
4. Time: 5 times maximum.

