

**SF2294E**

**922.5 MHz  
SAW Filter**

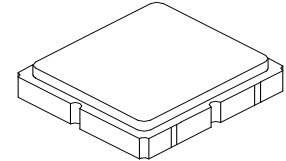

**SM3030-6**

- **Low Loss RF SAW Filter**
- **Surface Mount 3.0 x 3.0 mm Package**
- **Complies with Directive 2011/65/EU (RoHS)**
- **Moisture Sensitivity Level: 1**

**Absolute Maximum Ratings**

Rating	Value	Units
Input Power Level	16	dBm
DC Voltage on any Non-ground Terminal	5	V
Operable Temperature Range	-45 to +125	°C
Operating Temperature Range	-40 to +85	°C
Storage Temperature Range in Tape and Reel	-40 to +85	°C
Suitable for Lead-free Soldering - Maximum Soldering Profile	260°C for 30 s	

**Electrical Characteristics**

Characteristic	Sym	Notes	Min	Typ	Max	Units
Center Frequency	$f_c$			922.5		MHz
Insertion Loss, 920.0 to 925.0 MHz (-20 to +75°C) 920.0 to 925.0 MHz (-40 to +85°C)	IL			2.7	4.2	dB
					4.5	
Amplitude Ripple, 920.0 to 925.0 MHz				0.4	2.0	dB
Attenuation, Referenced to 0 dB:						dB
775 to 835 MHz			40	45		
835 to 895 MHz			36	44		
970 to 992 MHz			36	44		
992 to 1075 MHz			38	45		
Source Impedance	$Z_S$			50		$\Omega$
Load Impedance	$Z_L$			50		
Case Style	SM3030-6 3.0 x 3.0 mm Nominal Footprint					
Lid Symbolization (Y=year, WW=week, S=shift) dot=pin 1 indicator	A46, <u>YWWS</u>					
Standard Reel Quantity	Reel Size 7 Inch					500 Pieces/Reel
	Reel Size 13 Inch					3000 Pieces/Reel

**Electrical Connections**

Connection	Terminals
Input	2
Output	5
Case Ground	All others

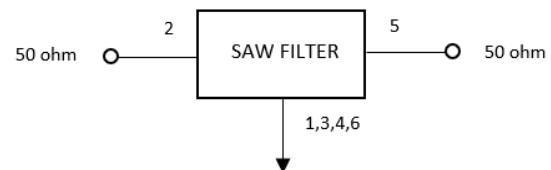

 **CAUTION: Electrostatic Sensitive Device. Observe precautions for handling.**

**NOTES:**

1. The design, manufacturing process, and specifications of this device are subject to change.
2. US or International patents may apply.
3. RoHS compliant from the first date of manufacture.

# Filter Response Plots

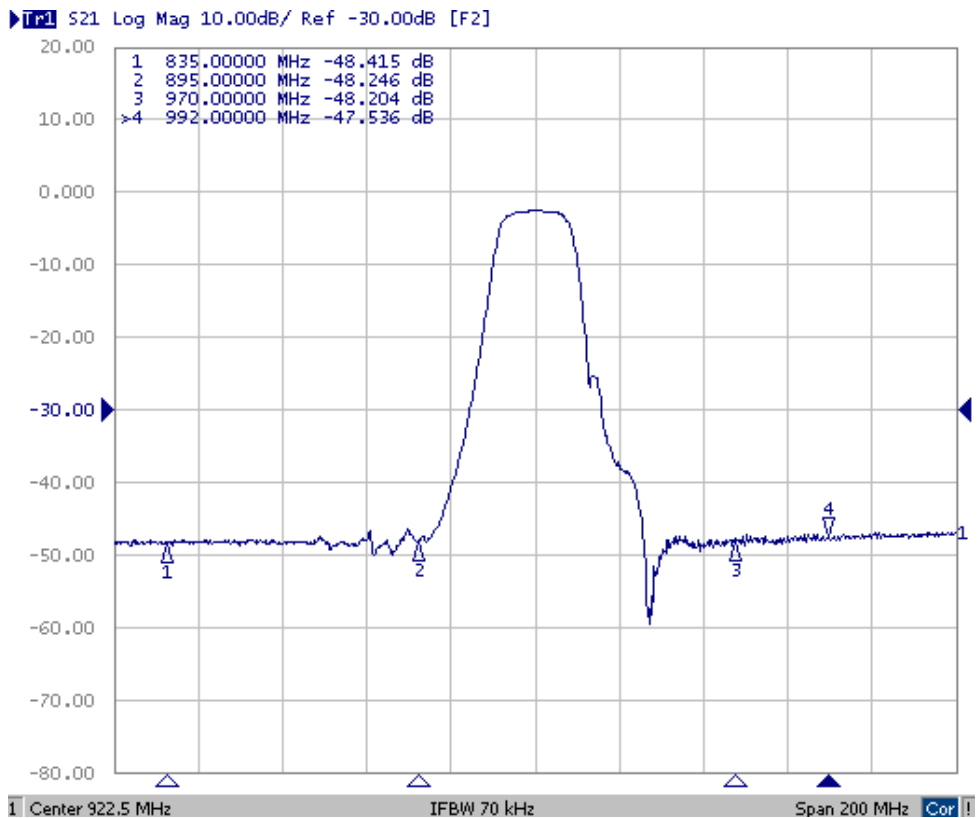
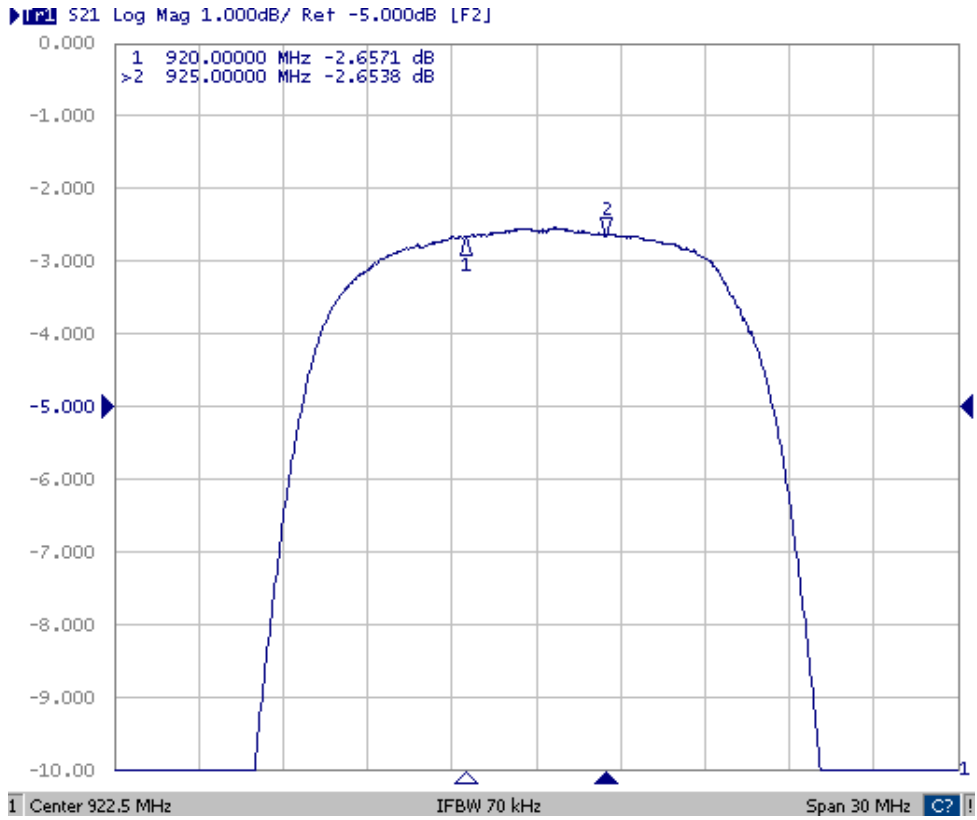

# SM3030-6 Case

## 6-Terminal Ceramic Surface-Mount Case 3.0 X 3.0 mm Nominal Footprint



PCB Footprint Top View

### Case and PCB Footprint Dimensions

Dimension	mm			Inches		
	Min	Nom	Max	Min	Nom	Max
A	2.87	3.00	3.13	0.113	0.118	0.123
B	2.87	3.00	3.13	0.113	0.118	0.123
C	1.12	1.25	1.38	0.044	0.049	0.054
D	0.77	0.90	1.03	0.030	0.035	0.040
E	2.67	2.80	2.93	0.105	0.110	0.115
F	1.47	1.60	1.73	0.058	0.063	0.068
G	0.72	0.85	0.98	0.028	0.033	0.038
H	1.37	1.50	1.63	0.054	0.059	0.064
I	0.47	0.60	0.73	0.019	0.024	0.029
J	1.17	1.30	1.43	0.046	0.051	0.056
K		3.20			0.126	
L		1.70			0.067	
M		1.05			0.041	
N		0.81			0.032	
O		0.38			0.015	

### Case Materials

Materials	
Solder Pad Plating	0.3 to 1.0 $\mu\text{m}$ Gold over 1.27 to 8.89 $\mu\text{m}$ Nickel
Lid Plating	2.0 to 3.0 $\mu\text{m}$ Nickel
Body	$\text{Al}_2\text{O}_3$ Ceramic

### TOP VIEW

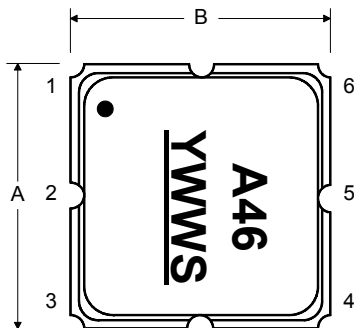

### BOTTOM VIEW

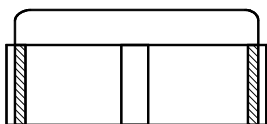
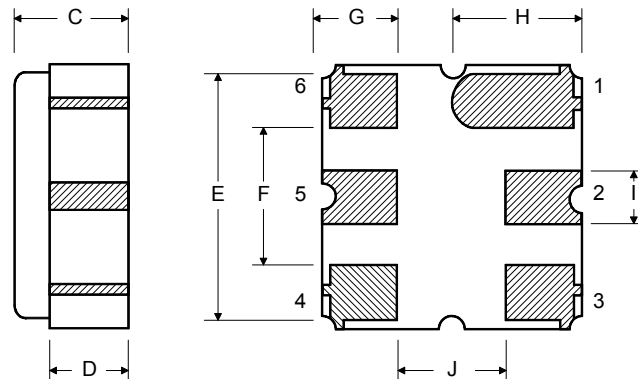

# Tape and Reel Specifications

Tape and Reel Standard per ANSI/EIA-481

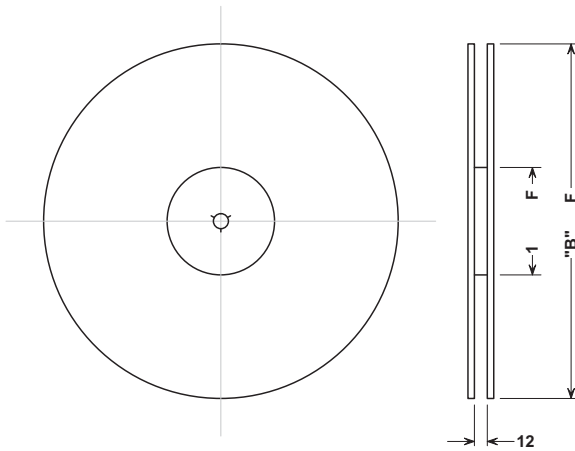

"B"		Quantity Per Reel
Inches	millimeters	
7	178	500
13	330	3000

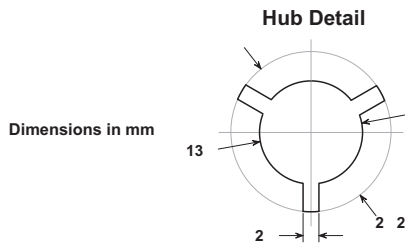

## COMPONENT ORIENTATION and DIMENSIONS

Carrier Tape Dimensions	
Ao	3.35 mm
Bo	3.35 mm
Ko	1.40 mm
Pitch	8.0 mm
W	12.0 mm

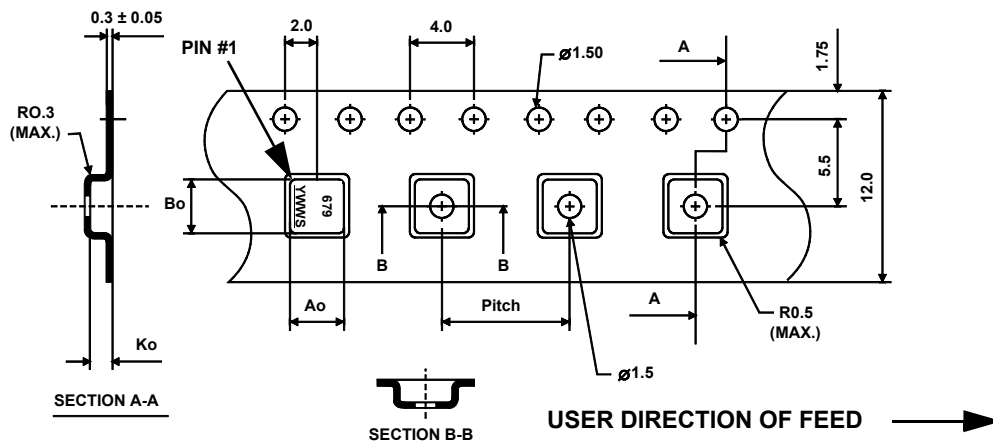

## Recommended Reflow Profile

1. Preheating shall be fixed at 150~180°C for 60~90 seconds.
2. Ascending time to preheating temperature 150°C shall be 30 seconds min.
3. Heating shall be fixed at 220°C for 50~80 seconds and at 260°C +0/-5°C peak (10 seconds).
4. Time: 5 times maximum.

