

# High Voltage Power MOSFET

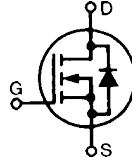
## IXTQ3N150M

$$V_{DSS} = 1500V$$

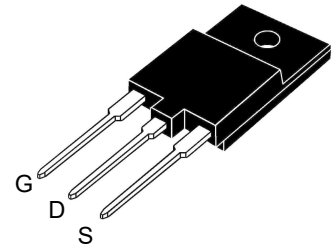
$$I_{D25} = 3A$$

$$R_{DS(on)} \leq 7.3\Omega$$

N-Channel Enhancement Mode  
Avalanche Rated  
Fast Intrinsic Diode



**OVERMOLDED  
(IXTQ...M)**



G = Gate      D = Drain  
S = Source

Symbol	Test Conditions	Maximum Ratings	
$V_{DSS}$	$T_J = 25^\circ\text{C}$ to $150^\circ\text{C}$	1500	V
$V_{DGR}$	$T_J = 25^\circ\text{C}$ to $150^\circ\text{C}$ , $R_{GS} = 1\text{ M}\Omega$	1500	V
$V_{GSS}$	Continuous	$\pm 30$	V
$V_{GSM}$	Transient	$\pm 40$	V
$I_{D25}$	$T_C = 25^\circ\text{C}$ , Limited by $T_{JM}$	3	A
$I_{DM}$	$T_C = 25^\circ\text{C}$ , Pulse Width Limited by $T_{JM}$	9	A
$I_A$	$T_C = 25^\circ\text{C}$	3	A
$E_{AS}$	$T_C = 25^\circ\text{C}$	250	mJ
$dv/dt$	$I_S \leq I_{DM}$ , $V_{DD} \leq V_{DSS}$ , $T_J = 150^\circ\text{C}$	5	V/ns
$P_D$	$T_C = 25^\circ\text{C}$	73	W
$T_J$		- 55 ... +150	$^\circ\text{C}$
$T_{JM}$		150	$^\circ\text{C}$
$T_{stg}$		- 55 ... +150	$^\circ\text{C}$
$T_L$	Maximum Lead Temperature for Soldering 1.6 mm (0.062 in.) from Case for 10s	300	$^\circ\text{C}$
$M_d$	Mounting Torque	1.13/10	Nm/lb.in.
<b>Weight</b>		6	g

Symbol	Test Conditions ( $T_J = 25^\circ\text{C}$ , Unless Otherwise Specified)	Characteristic Values		
		Min.	Typ.	Max.
$BV_{DSS}$	$V_{GS} = 0V$ , $I_D = 250\mu\text{A}$	1500		V
$V_{GS(th)}$	$V_{DS} = V_{GS}$ , $I_D = 250\mu\text{A}$	2.5		5.0 V
$I_{GSS}$	$V_{GS} = \pm 30V$ , $V_{DS} = 0V$			$\pm 100$ nA
$I_{DSS}$	$V_{DS} = V_{DSS}$ , $V_{GS} = 0V$ $T_J = 125^\circ\text{C}$			10 $\mu\text{A}$ 100 $\mu\text{A}$
$R_{DS(on)}$	$V_{GS} = 10V$ , $I_D = 1.5A$ , Note 1			7.3 $\Omega$

### Features

- Plastic Overmolded Tab for Electrical Isolation
- Avalanche Rated
- Fast Intrinsic Diode
- Low Package Inductance

### Advantages

- High Power Density
- Easy to Mount
- Space Savings

### Applications

- High Voltage Power Supplies
- Capacitor Discharge Applications
- Pulse Circuits

Symbol	Test Conditions ( $T_J = 25^\circ\text{C}$ , Unless Otherwise Specified)	Characteristic Values		
		Min.	Typ.	Max.
$g_{fs}$	$V_{DS} = 20\text{V}, I_D = 1.5\text{A}$ , Note 1	2.2	3.6	S
$C_{iss}$	$V_{GS} = 0\text{V}, V_{DS} = 25\text{V}, f = 1\text{MHz}$		1375	pF
$C_{oss}$			90	pF
$C_{rss}$			30	pF
$R_{GI}$	Gate Input Resistance		3.0	$\Omega$
$t_{d(on)}$	<b>Resistive Switching Times</b> $V_{GS} = 10\text{V}, V_{DS} = 0.5 \cdot V_{DSS}, I_D = 1.5\text{A}$ $R_G = 5\Omega$ (External)		19	ns
$t_r$			21	ns
$t_{d(off)}$			42	ns
$t_f$			25	ns
$Q_{g(on)}$	$V_{GS} = 10\text{V}, V_{DS} = 0.5 \cdot V_{DSS}, I_D = 1.5\text{A}$		38.6	nC
$Q_{gs}$			6.5	nC
$Q_{gd}$			19.0	nC
$R_{thJC}$				1.7 $^\circ\text{C/W}$
$R_{thCS}$		0.21		$^\circ\text{C/W}$

**Source-Drain Diode**

Symbol	Test Conditions ( $T_J = 25^\circ\text{C}$ , Unless Otherwise Specified)	Characteristic Values		
		Min.	Typ.	Max
$I_S$	$V_{GS} = 0\text{V}$ , Note 1			3 A
$I_{SM}$	Repetitive, Pulse Width Limited by $T_{JM}$			12 A
$V_{SD}$	$I_F = I_S, V_{GS} = 0\text{V}$ , Note 1			1.3 V
$t_{rr}$	$I_F = 1.5\text{A}, -di/dt = 100\text{A}/\mu\text{s}$ $V_R = 100\text{V}$		0.9	$\mu\text{s}$
$Q_{RM}$			6.7	$\mu\text{C}$
$I_{RM}$			15	A

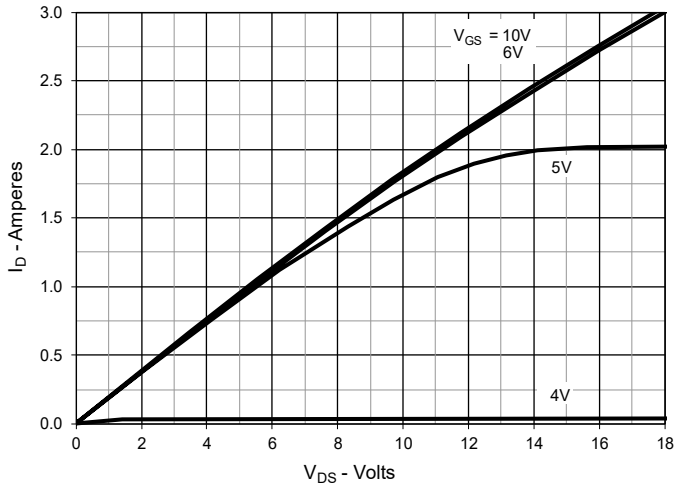
Note 1. Pulse test,  $t \leq 300\mu\text{s}$ , duty cycle,  $d \leq 2\%$ .

Littelfuse reserves the right to change limits, test conditions, and dimensions.

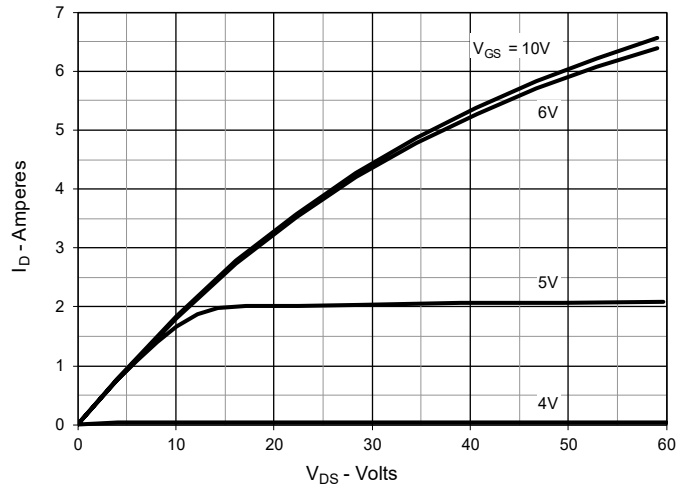
IXYS MOSFETs and IGBTs are covered by one or more of the following U.S. patents:

4,835,592	4,931,844	5,049,961	5,237,481	6,162,665	6,404,065 B1	6,683,344	6,727,585	7,005,734 B2	7,157,338B2
4,860,072	5,017,508	5,063,307	5,381,025	6,259,123 B1	6,534,343	6,710,405 B2	6,759,692	7,063,975 B2	
4,881,106	5,034,796	5,187,117	5,486,715	6,306,728 B1	6,583,505	6,710,463	6,771,478 B2	7,071,537	

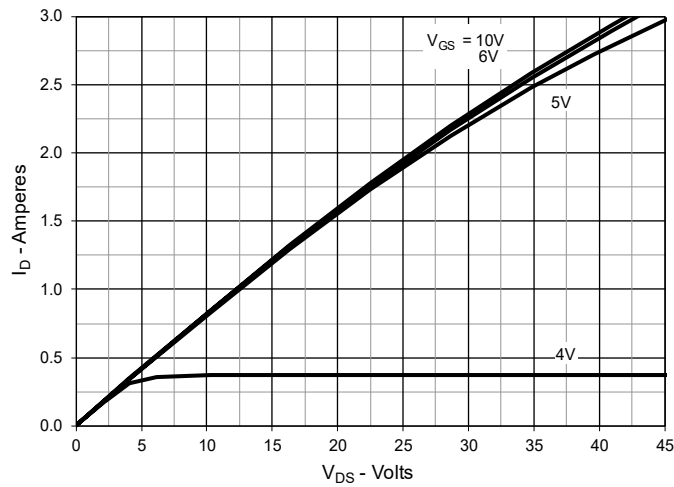
**Fig. 1. Output Characteristics @  $T_J = 25^\circ\text{C}$**



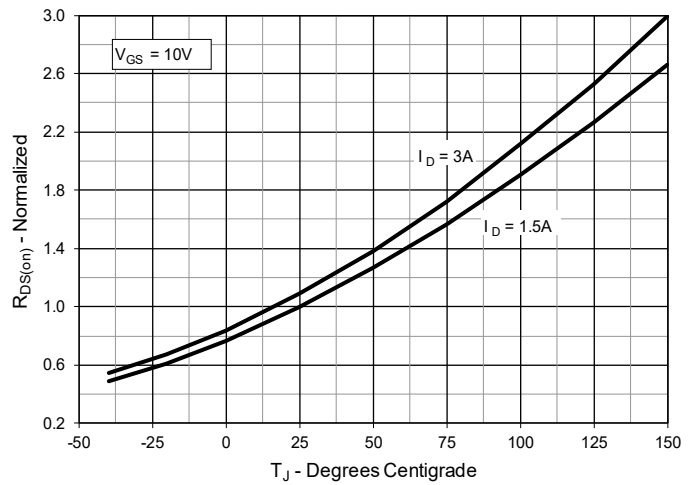
**Fig. 2. Extended Output Characteristics @  $T_J = 25^\circ\text{C}$**



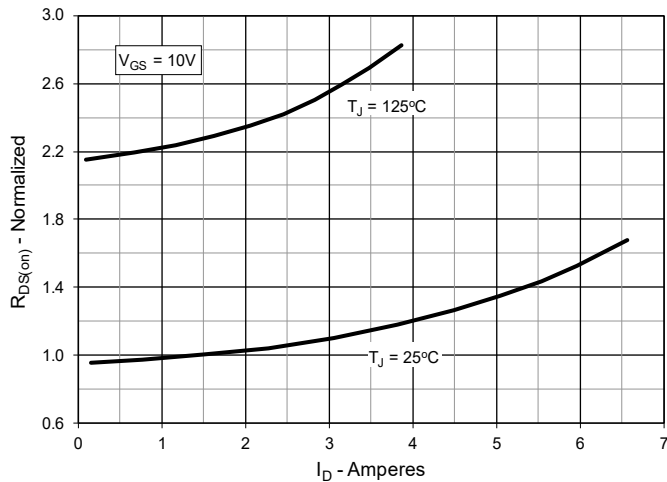
**Fig. 3. Output Characteristics @  $T_J = 125^\circ\text{C}$**



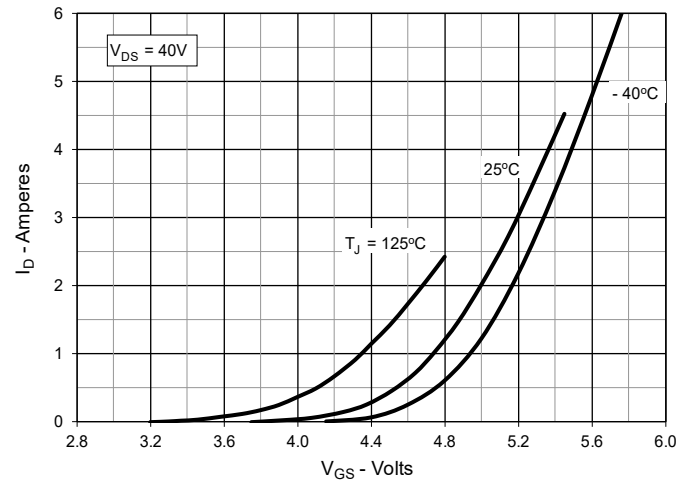
**Fig. 4.  $R_{DS(on)}$  Normalized to  $I_D = 1.5\text{A}$  Value vs. Junction Temperature**



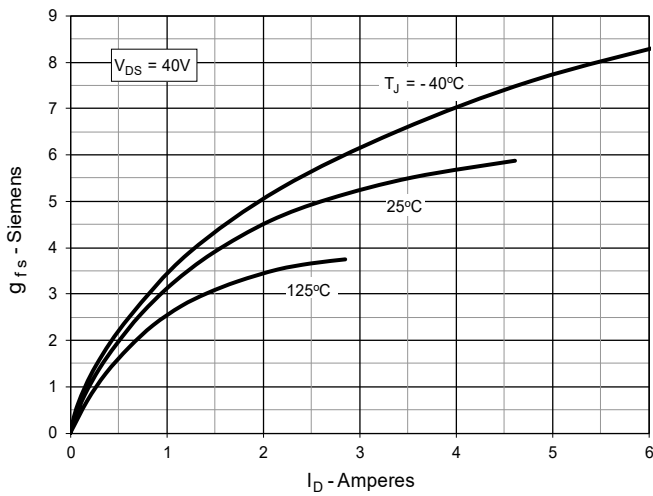
**Fig. 5.  $R_{DS(on)}$  Normalized to  $I_D = 1.5\text{A}$  Value vs. Drain Current**



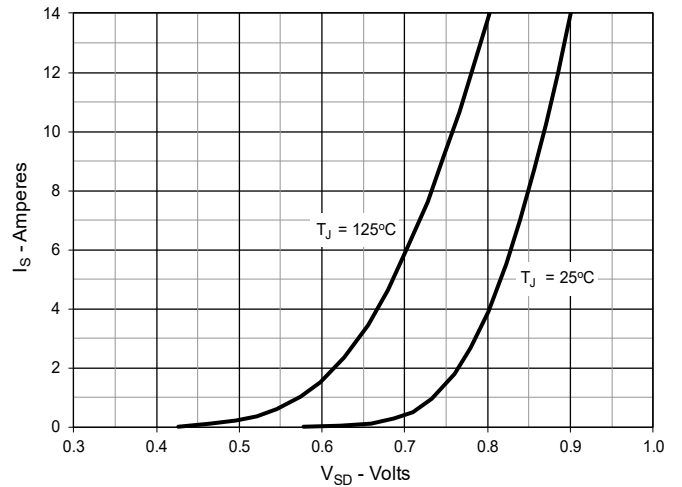
**Fig. 6. Input Admittance**



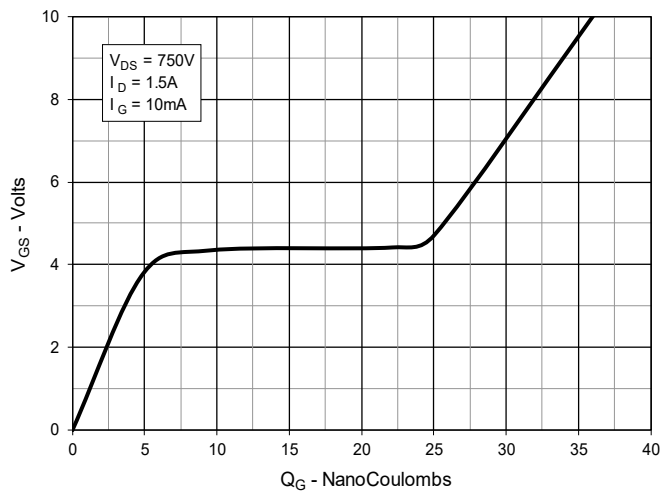
**Fig. 7. Transconductance**



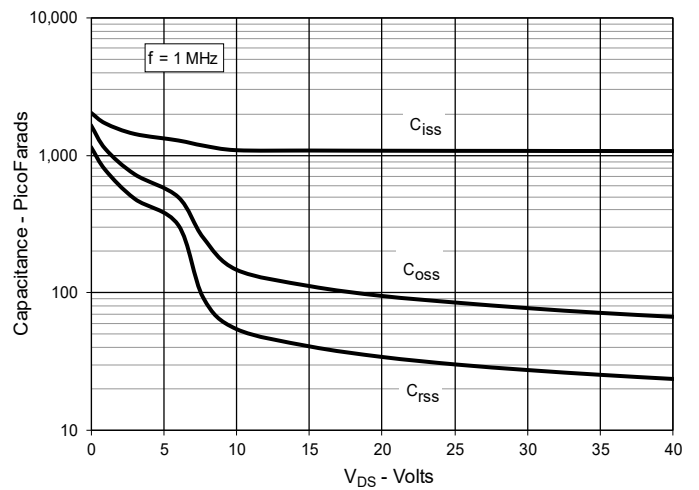
**Fig. 8. Forward Voltage Drop of Intrinsic Diode**



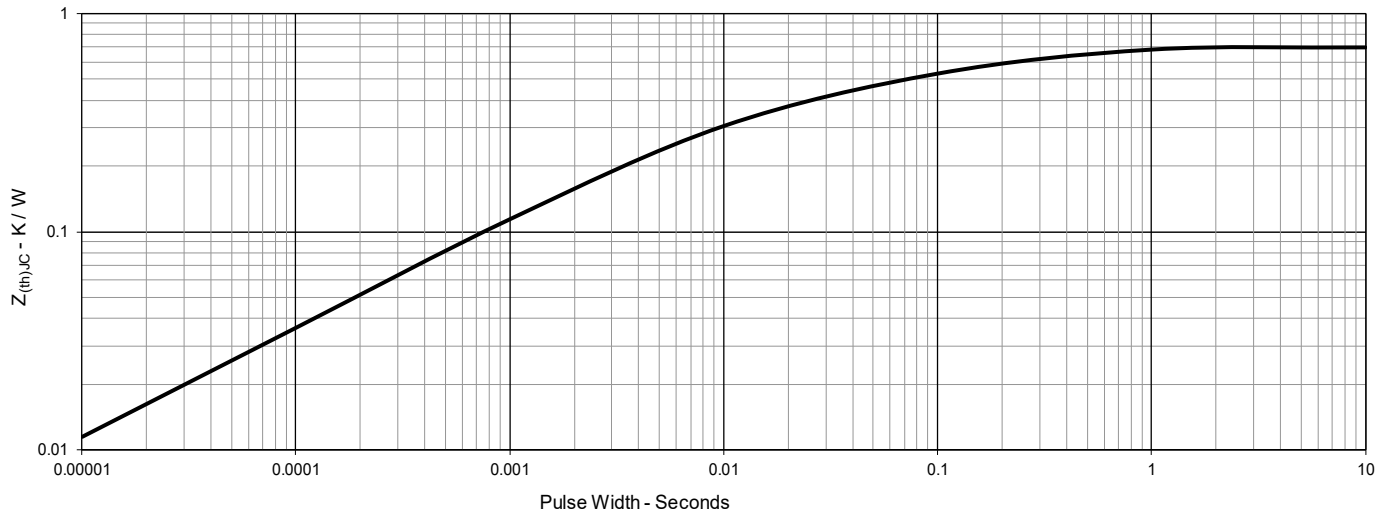
**Fig. 9. Gate Charge**



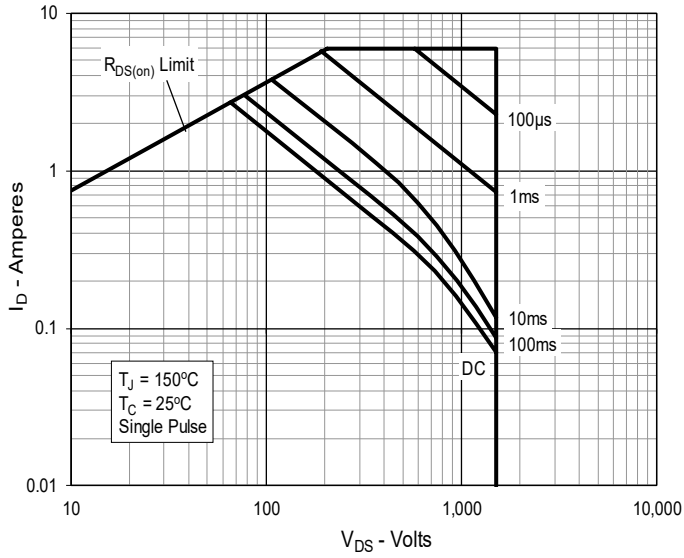
**Fig. 10. Capacitance**



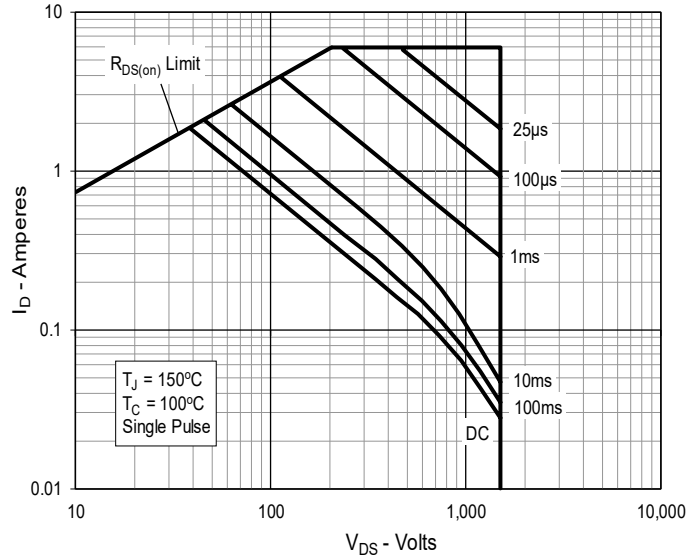
**Fig. 12. Maximum Transient Thermal Impedance**

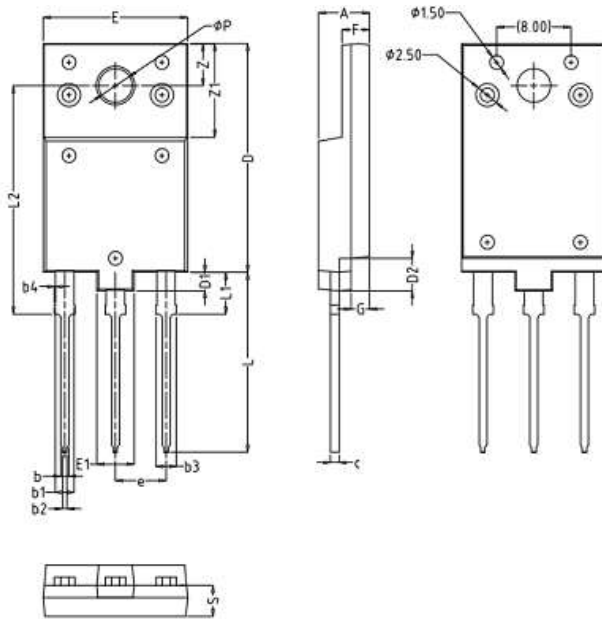


**Fig. 12. Forward-Bias Safe Operating Area  
@  $T_C = 25^\circ\text{C}$**



**Fig. 13. Forward-Bias Safe Operating Area  
@  $T_C = 100^\circ\text{C}$**



**TO-3PFP Outline**


SYMBOL	MIN	MAX
A	5.30	5.70
b	0.65	0.95
b1	1.81	2.19
b2	0.30	0.70
b3	1.81	2.40
b4	-	0.20
c	0.80	1.00
D	24.20	24.80
D1	1.80	2.20
D2	3.30	3.70
E	15.30	15.70
E1	3.80	4.20
F	2.80	3.20
e	5.45 BSC	
L	19.00	19.60
L1	4.20	4.80
L2	24.20	24.80
P	3.40	3.80
Z	4.30	4.70
Z1	9.70	10.30
G	1.80	2.20
S	3.10	3.50