

May 1992

Features

- 12A and 14A, 80V - 100V
- $r_{DS(on)} = 0.16\Omega$ and 0.23Ω
- Single Pulse Avalanche Energy Rated*
- SOA is Power-Dissipation Limited
- Nanosecond Switching Speeds
- Linear Transfer Characteristics
- High Input Impedance

Description

The IRF530, IRF531, IRF532, and IRF533 are n-channel enhancement-mode silicon-gate power field-effect transistors. IRF530R, IRF531R, IRF532R and IRF533R types are advanced power MOSFETs designed, tested, and guaranteed to withstand a specified level of energy in the breakdown avalanche mode of operation. All of these power MOSFETs are designed for applications such as switching regulators, switching converters, motor drivers, relay drivers, and drivers for high-power bipolar switching transistors requiring high speed and low gate-drive power. These types can be operated directly from integrated circuits.

The IRF types are supplied in the JEDEC TO-220AB plastic package.

Package

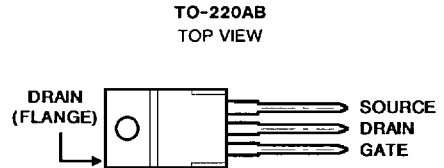

Terminal Diagram

N-CHANNEL ENHANCEMENT MODE

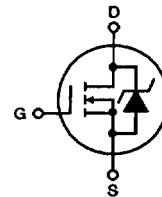

Absolute Maximum Ratings ($T_C = +25^\circ\text{C}$), Unless Otherwise Specified

	IRF530 IRF530R	IRF531 IRF531R	IRF532 IRF532R	IRF533 IRF533R	UNITS	
Drain-Source Voltage (1)	V_{DS}	100	80	100	80	V
Drain-Gate Voltage ($R_{GS} = 20k\Omega$) (1)	V_{DGR}	100	80	100	80	V
Continuous Drain Current						
$T_C = +25^\circ\text{C}$	I_D	14	14	12	12	A
$T_C = +100^\circ\text{C}$	I_D	10	10	8.3	8.3	A
Pulsed Drain Current (3)	I_{DM}	56	56	48	48	A
Gate-Source Voltage	V_{GS}	± 20	± 20	± 20	± 20	V
Maximum Power Dissipation						
$T_C = +25^\circ\text{C}$	P_D	79	79	79	79	W
Linear Derating Factor		0.53	0.53	0.53	0.53	W/ $^\circ\text{C}$
Inductive Current, Clamped	I_{LM}	56	56	48	48	A
(See Figure 14, $L = 100\mu\text{H}$)						
Single Pulse Avalanche Energy Rating (4)	E_{AS}^*	69	69	69	69	mJ
Operating and Storage Junction	T_J, T_{STG}	-55 to +175	-55 to +175	-55 to +175	-55 to +175	$^\circ\text{C}$
Temperature Range						
Maximum Lead Temperature for Soldering	T_L	300	300	300	300	$^\circ\text{C}$
(0.063" (1.6mm) from case for 10s)						

NOTES:

1. $T_J = +25^\circ\text{C}$ to $+150^\circ\text{C}$.
2. Pulse Test: Pulse width $\leq 300\mu\text{s}$, Duty Cycle $\leq 2\%$.
3. Repetitive rating: Pulse width limited by maximum junction temperature. See Transient Thermal Impedance Curve (Figure 5).
- *R Suffix Types Only
4. $V_{DD} = 25\text{V}$, starting $T_J = +25^\circ\text{C}$, $L = 530\mu\text{H}$, $R_{GS} = 25\Omega$, $I_{PEAK} = 14\text{A}$. See Figure 15.

IRF530, IRF531, IRF532, IRF533 IRF530R, IRF531R, IRF532R, IRF533R

Electrical Characteristics $T_C = 25^\circ\text{C}$, Unless Otherwise Specified

CHARACTERISTIC	SYMBOL	TEST CONDITIONS	LIMITS			UNITS
			MIN	TYP	MAX	
Drain-Source Breakdown Voltage IRF530/532, IRF530R/532R IRF531/533, IRF531R/533R	BV _{DSS}	$V_{GS} = 0V, I_D = 250\mu A$	100	-	-	V
			80	-	-	V
Gate Threshold Voltage	$V_{GS(TH)}$	$V_{DS} = V_{GS}, I_D = 250\mu A$	2.0	-	4.0	V
Gate-Source Leakage Forward	I_{GSS}	$V_{GS} = 20V$	-	-	500	nA
Gate-Source Leakage Reverse	I_{GSS}	$V_{GS} = -20V$	-	-	-500	nA
Zero Gate Voltage Drain Current	I_{DSS}	$V_{DS} = \text{Max Rating}, V_{GS} = 0V$	-	-	250	μA
		$V_{DS} = \text{Max Rating} \times 0.8, V_{GS} = 0V, T_J = +125^\circ\text{C}$	-	-	1000	μA
On-State Drain Current (Note 2) IRF530/531, IRF530R/531R IRF532/533, IRF532R/533R	$I_{D(ON)}$	$V_{DS} > I_{D(ON)} \times r_{DS(ON)} \text{ Max}, V_{GS} = 10V$	14	-	-	A
			12	-	-	A
Static Drain-Source On-State Resistance (Note 2) IRF530/531, IRF530R/531R IRF532/533, IRF532R/533R	$r_{DS(ON)}$	$V_{GS} = 10V, I_D = 8.3A$	-	0.14	0.16	Ω
			-	0.20	0.23	Ω
Forward Transconductance (Note 2)	g_{fs}	$V_{DS} \geq 50V, I_D = 8.3A$	5.1	7.6	-	S(Ω)
Input Capacitance	C_{ISS}	$V_{GS} = 0V, V_{DS} = 25V, f = 1.0\text{MHz}$	-	600	-	pF
Output Capacitance	C_{OSS}	See Figure 10	-	250	-	pF
Reverse Transfer Capacitance	C_{RSS}		-	50	-	pF
Turn-On Delay Time	$t_{d(ON)}$	$V_{DD} = 50V, I_D \approx 14A, R_G = 12\Omega$	-	12	15	ns
Rise Time	t_r	See Figure 16. (MOSFET switching times are essentially independent of operating temperature)	-	35	51	ns
Turn-Off Delay Time	$t_{d(OFF)}$		-	25	35	ns
Fall Time	t_f		-	25	36	ns
Total Gate Charge (Gate-Source + Gate-Drain)	Q_g	$V_{GS} = 10V, I_D = 14A, V_{DS} = 0.8V$ Max Rating. See Figure 17 for test circuit.	-	18	26	nC
Gate-Source Charge	Q_{gs}	(Gate charge is essentially independent of operating temperature.)	-	4	-	nC
Gate-Drain ("Miller") Charge	Q_{gd}		-	7	-	nC
Internal Drain Inductance	L_D	Measured from the contact screw on tab to center of die	-	3.5	-	nH
		Measured from the drain lead, 6mm (0.25in.) from package to center of die	-	4.5	-	nH
Internal Source Inductance	L_S	Measured from the source lead, 6mm (0.25") from header and source bonding pad.	-	7.5	-	nH

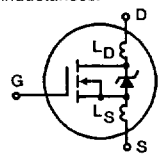

4
N-CHANNEL POWER MOSFETS

Source Drain Diode Ratings and Characteristics

Continuous Source Current (Body Diode)	I_S	Modified MOSFET symbol showing the integral reverse P-N junction rectifier.	-	-	14	A
Pulse Source Current (Body Diode) (Note 3)	I_{SM}		-	-	56	A
Diode Forward Voltage (Note 2)	V_{SD}	$T_J = +25^\circ\text{C}, I_S = 14A, V_{GS} = 0V$	-	-	2.5	V
Reverse Recovery Time	t_{rr}	$T_J = +25^\circ\text{C}, I_F = 14A, dI_F/dt = 100A/\mu s$	5.5	120	250	ns
Reverse Recovered Charge	Q_{RR}	$T_J = +25^\circ\text{C}, I_F = 14A, dI_F/dt = 100A/\mu s$	0.26	0.6	1.3	μC
Forward Turn-on Time	t_{ON}	Intrinsic turn-on time is negligible. Turn-on speed is substantially controlled by $L_S + L_D$.	-	-	-	-

NOTES: 1. $T_J = +25^\circ\text{C}$ to $+150^\circ\text{C}$
 2. Pulse Test: Pulse width $\leq 300\mu s$, Duty Cycle $\leq 2\%$
 3. Repetitive Rating: Pulse width limited by max. junction temperature. See Transient Thermal Impedance Curve (Figure 5)
 4. $V_{DD} = 25V$, Start $T_J = +25^\circ\text{C}$, $L = 350\mu H$, $R_{GS} = 25\Omega$, $I_{PEAK} = 14A$ (See Figure 15)

Performance Curves

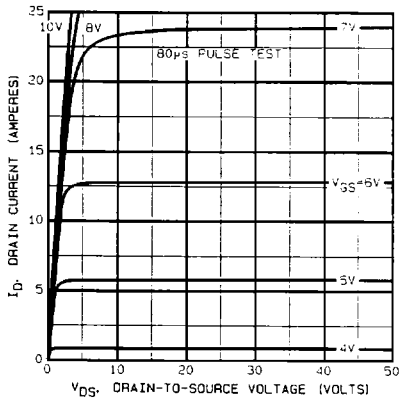

FIGURE 1. TYPICAL OUTPUT CHARACTERISTICS

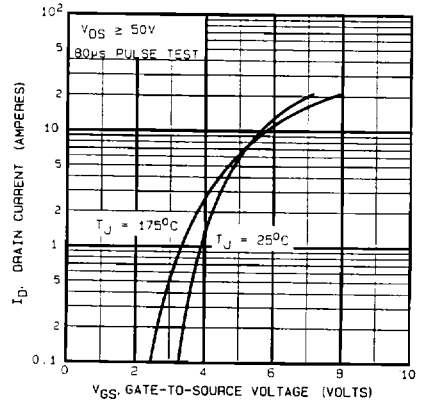

FIGURE 2. TYPICAL TRANSFER CHARACTERISTICS

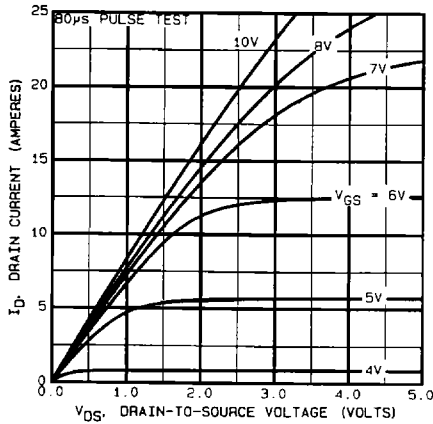

FIGURE 3. TYPICAL SATURATION CHARACTERISTICS

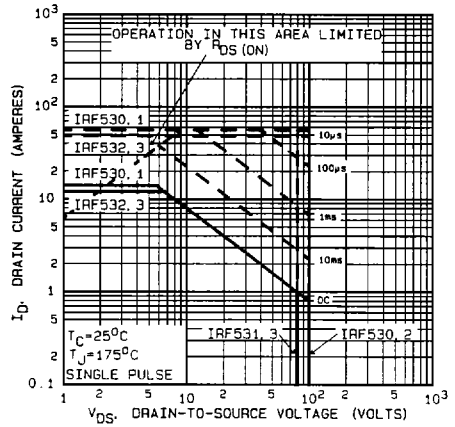

FIGURE 4. MAXIMUM SAFE OPERATING AREA

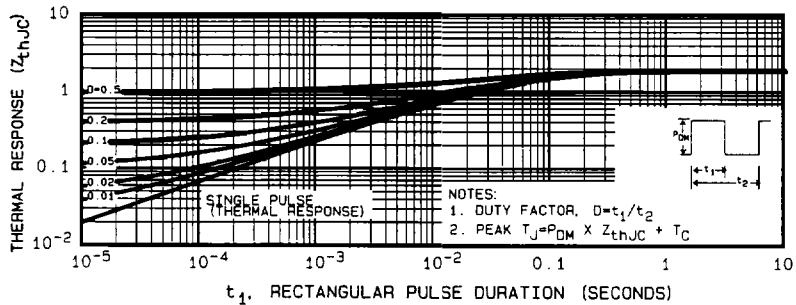

FIGURE 5. MAXIMUM EFFECTIVE TRANSIENT THERMAL IMPEDANCE, JUNCTION-TO-CASE vs PULSE DURATION

Performance Curves (Continued)

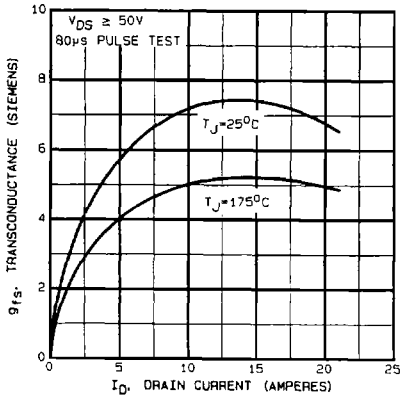

FIGURE 6. TYPICAL TRANSCONDUCTANCE vs DRAIN CURRENT

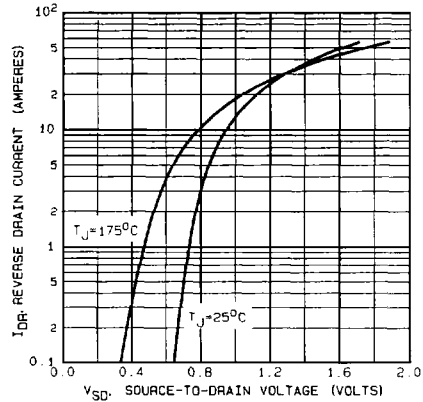

FIGURE 7. TYPICAL SOURCE-DRAIN DIODE FORWARD VOLTAGE

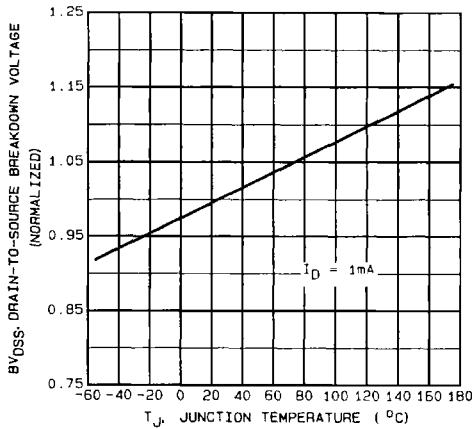

FIGURE 8. BREAKDOWN VOLTAGE vs TEMPERATURE

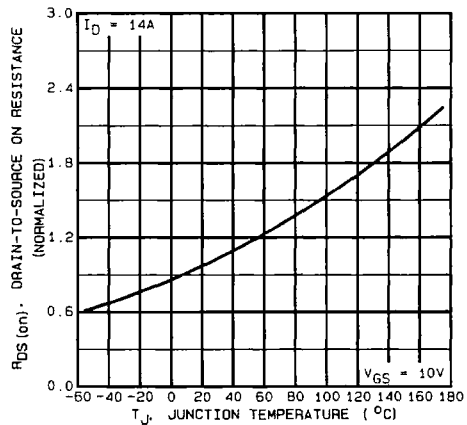

FIGURE 9. NORMALIZED ON-RESISTANCE vs TEMPERATURE

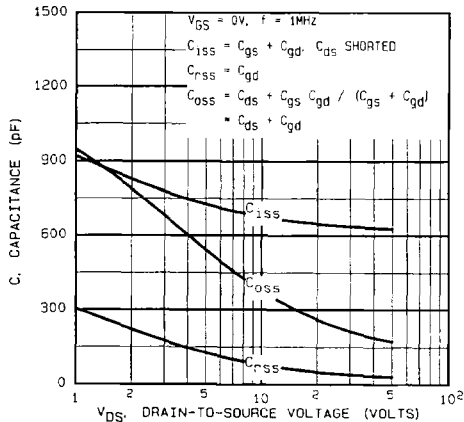

FIGURE 10. TYPICAL CAPACITANCE vs DRAIN-TO-SOURCE VOLTAGE

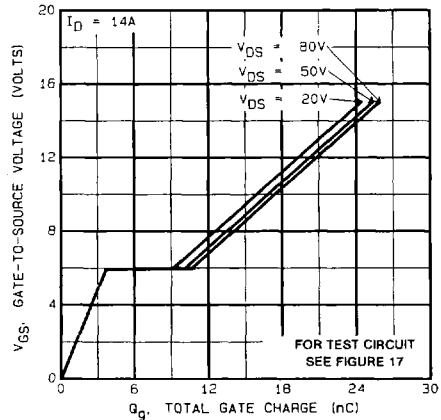

FIGURE 11. TYPICAL GATE CHARGE vs GATE-TO-SOURCE VOLTAGE

4
N-CHANNEL
POWER MOSFETS

Performance Curves (Continued)

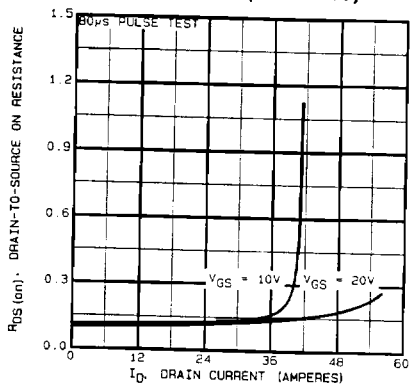

FIGURE 12. TYPICAL ON RESISTANCE vs DRAIN CURRENT

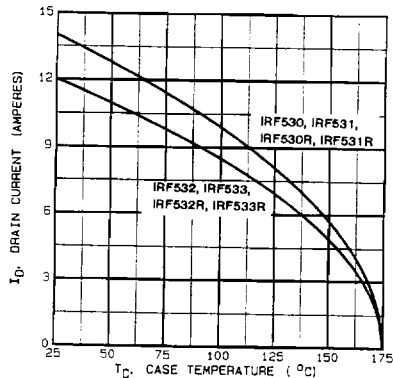

FIGURE 13. MAXIMUM DRAIN CURRENT vs CASE TEMPERATURE

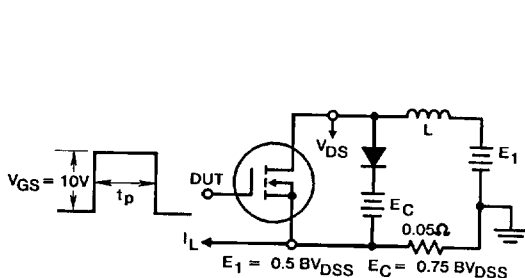

FIGURE 14a. CLAMPED INDUCTIVE TEST CIRCUIT

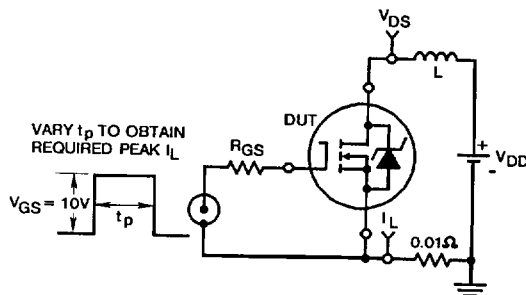

FIGURE 15a. UNCLAMPED ENERGY TEST CIRCUIT

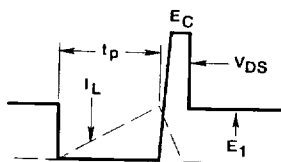

FIGURE 14b. CLAMPED INDUCTIVE WAVEFORMS

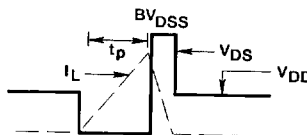

FIGURE 15b. UNCLAMPED ENERGY WAVEFORMS

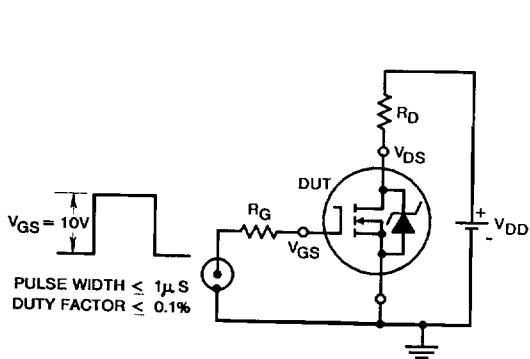

FIGURE 16. SWITCHING TIME TEST CIRCUIT

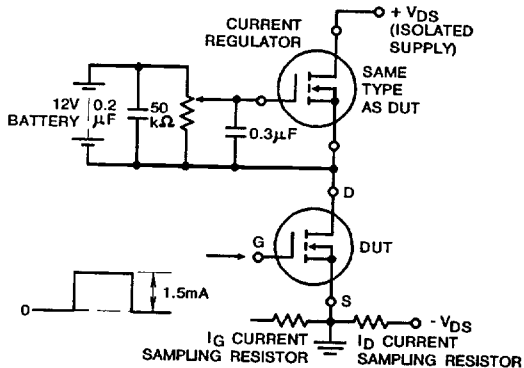

FIGURE 17. GATE CHARGE TEST CIRCUIT