

January 1998

Features

- 6.2A and 5.4A, 600V
- $r_{DS(ON)} = 1.2\Omega$ and 1.6Ω
- Repetitive Avalanche Energy Rated
- Simple Drive Requirements
- Ease of Paralleling
- Related Literature
 - TB334, "Guidelines for Soldering Surface Mount Components to PC Boards"

Ordering Information

PART NUMBER	PACKAGE	BRAND
IRFBC40	TO-220AB	IRFBC40
IRFBC42	TO-220AB	IRFBC42

NOTE: When ordering, include the entire part number.

Description

These are N-Channel enhancement mode silicon gate power field effect transistors. They are advanced power MOSFETs designed, tested, and guaranteed to withstand a specified level of energy in the breakdown avalanche mode of operation. All of these power MOSFETs are designed for applications such as switching regulators, switching converters, motor drivers, relay drivers, and drivers for high power bipolar switching transistors requiring high speed and low gate drive power. These types can be operated directly from integrated circuits.

Formerly developmental type TA17426.

Symbol

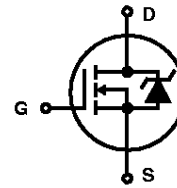

Packaging

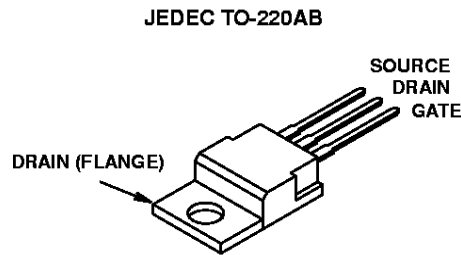

IRFBC40, IRFBC42

Absolute Maximum Ratings $T_C = 25^\circ\text{C}$, Unless Otherwise Specified

		IRFBC40	IRFBC42	UNITS
Drain to Source Breakdown Voltage (Note 1)	V_{DS}	600	600	V
Drain to Gate Voltage ($R_{GS} = 20k\Omega$) (Note 1)	V_{DGR}	600	600	V
Continuous Drain Current	I_D	6.2	5.4	A
$T_C = 100^\circ\text{C}$	I_D	3.9	3.4	A
Pulsed Drain Current (Note 2)	I_{DM}	25	22	A
Gate to Source Voltage	V_{GS}	± 20	± 20	V
Maximum Power Dissipation	P_D	125	125	W
Linear Derating Factor		1.0	1.0	$W/^\circ\text{C}$
Single Pulse Avalanche Energy Rating (Note 2) (See Figures 15,16)	E_{AS}	570	570	mJ
Operating and Storage Temperature	T_J, T_{STG}	-55 to 150	-55 to 150	$^\circ\text{C}$
Maximum Temperature for Soldering				
Leads at 0.063in (1.6mm) from Case for 10s	T_L	300	300	$^\circ\text{C}$
Package Body for 10s, See Techbrief 334.	T_{pkg}	260	260	$^\circ\text{C}$

CAUTION: Stresses above those listed in "Absolute Maximum Ratings" may cause permanent damage to the device. This is a stress only rating and operation of the device at these or any other conditions above those indicated in the operational sections of this specification is not implied.

NOTE:

- $T_J = 25^\circ\text{C}$ to 125°C .

Electrical Specifications $T_C = 25^\circ\text{C}$, Unless Otherwise Specified

PARAMETER	SYMBOL	TEST CONDITIONS	MIN	TYP	MAX	UNITS	
Drain to Source Breakdown Voltage	BV_{DSS}	$V_{GS} = 0V, I_D = 250\mu\text{A}$, (Figure 11)	600	-	-	V	
Gate to Source Threshold Voltage	$V_{GS(TH)}$	$V_{GS} = V_{DS}, I_D = 250\mu\text{A}$	2.0	-	4.0	V	
Zero Gate Voltage Drain Current	I_{DSS}	$V_{DS} = \text{Rated } BV_{DSS}, V_{GS} = 0V$	-	-	25	μA	
		$V_{DS} = 0.8 \times \text{Rated } BV_{DSS}, V_{GS} = 0V, T_J = 125^\circ\text{C}$	-	-	250	μA	
On-State Drain Current (Note 4)	$I_{D(ON)}$	$V_{DS} > I_{D(ON)} \times r_{DS(ON)MAX}, V_{GS} = 10V$	IRFBC40	6.2	-	-	A
			IRFBC42	5.4	-	-	A
Gate to Source Leakage	I_{GSS}	$V_{GS} = \pm 20V$	-	-	± 100	nA	
Drain to Source On Resistance (Note 2)	$r_{DS(ON)}$	$V_{GS} = 10V, I_D = 3.4A$, (Figures 9, 10)	IRFBC40	-	0.97	1.2	Ω
			IRFBC42	-	1.2	1.6	Ω
Forward Transconductance (Note 4)	g_{fs}	$V_{DS} \geq 100V, I_{DS} = 3.4A$, (Figure 13)	4.7	70	-	S	
Turn-On Delay Time	$t_{d(ON)}$	$V_{DD} = 300V, I_D \approx 6.2A, R_G = 9.1\Omega, V_{GS} = 10V, R_L = 47\Omega$, (Figures 17, 18) Switching Speeds are Essentially Independent of Operating Temperature	-	13	20	ns	
Rise Time	t_r		-	18	27	ns	
Turn-Off Delay Time	$t_{d(OFF)}$		-	55	83	ns	
Fall Time	t_f		-	20	30	ns	
Total Gate Charge (Gate to Source + Gate to Drain)	$Q_g(TOT)$		$V_{GS} = 10V, I_D = 6.2A, V_{DS} = 0.7 \times \text{Rated } BV_{DSS}$, (Figures 19, 20)	-	40	60	nC
Gate to Source Charge	Q_{gs}	Gate Charge is Essentially Independent of Operating Temperature	-	5.5	-	nC	
Gate to Drain "Miller" Charge	Q_{gd}		-	20	-	nC	
Input Capacitance	C_{ISS}		$V_{GS} = 0V, V_{DS} = 25V, f = 1.0\text{MHz}$, (Figure 12)	-	1300	-	pF
Output Capacitance	C_{OSS}		-	160	-	pF	
Reverse Transfer Capacitance	C_{RSS}		-	45	-	pF	

IRFBC40, IRFBC42

Electrical Specifications $T_C = 25^\circ\text{C}$, Unless Otherwise Specified (Continued)

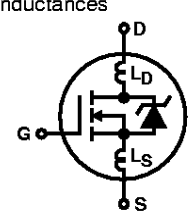
PARAMETER	SYMBOL	TEST CONDITIONS		MIN	TYP	MAX	UNITS
Internal Drain Inductance	L_D	Measured From the Drain Lead, 6mm (0.25in) From Package to Center of Die	Modified MOSFET Symbol Showing the Internal Devices Inductances 	-	4.5	-	nH
Internal Source Inductance	L_S	Measured From the Source Lead, 6mm (0.25in) From Header to Source Bonding Pad		-	7.5	-	nH
Thermal Resistance Junction to Case	$R_{\theta JC}$			-	-	1.0	$^\circ\text{C/W}$
Thermal Resistance Junction to Ambient	$R_{\theta JA}$	Typical Socket Mount		-	-	80	$^\circ\text{C/W}$

Source to Drain Diode Specifications

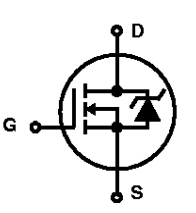
PARAMETER	SYMBOL	TEST CONDITIONS		MIN	TYP	MAX	UNITS
Continuous Source to Drain Current	I_{SD}	Modified MOSFET Symbol Showing the Integral Reverse P-N Junction Diode 		-	-	6.2	A
Pulse Source to Drain Current (Note 3)	I_{SDM}			-	-	25	A
Diode Source to Drain Voltage (Note 2)	V_{SD}	$T_J = 25^\circ\text{C}$, $I_{SD} = 6.2\text{A}$, $V_{GS} = 0\text{V}$, (Figure 8)		-	-	1.5	V
Reverse Recovery Time	t_{rr}	$T_J = 25^\circ\text{C}$, $I_{SD} = 6.2\text{A}$, $dI_{SD}/dt = 100\text{A}/\mu\text{s}$		200	450	940	ns
Reverse Recovery Charge	Q_{RR}	$T_J = 25^\circ\text{C}$, $I_{SD} = 6.2\text{A}$, $dI_{SD}/dt = 100\text{A}/\mu\text{s}$		1.8	3.8	8.0	μC

NOTES:

2. Pulse test: pulse width $\leq 300\mu\text{s}$, duty cycle $\leq 2\%$.
3. Repetitive rating: pulse width limited by Max junction temperature. See Transient Thermal Impedance curve (Figure 3).
4. $V_{DD} = 50\text{V}$, starting $T_J = 25^\circ\text{C}$, $L = 16\text{mH}$, $R_G = 25\Omega$, peak $I_{AS} = 6.8\text{A}$. (Figures 15, 16).

Typical Performance Curves Unless Otherwise Specified

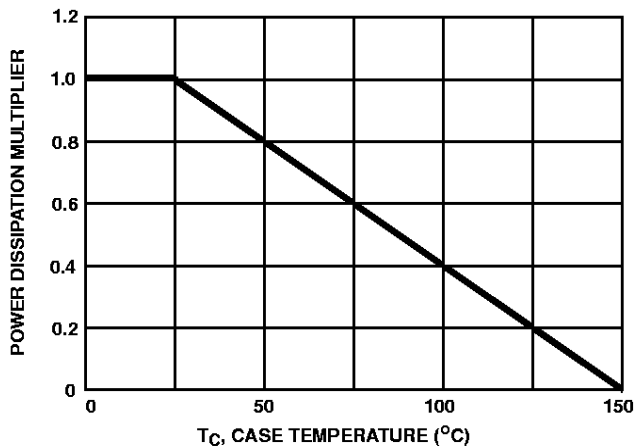

FIGURE 1. NORMALIZED POWER DISSIPATION vs CASE TEMPERATURE

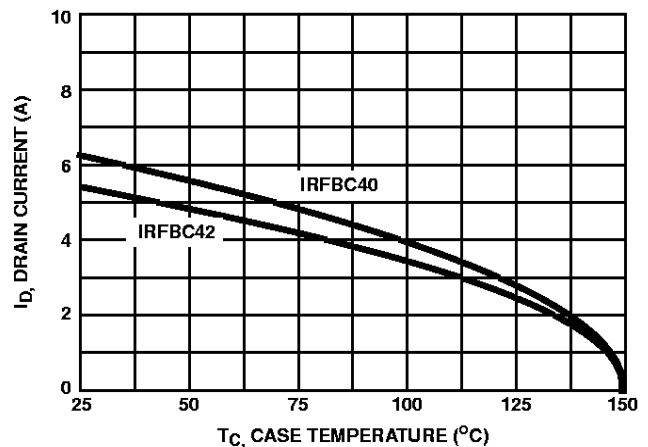

FIGURE 2. MAXIMUM CONTINUOUS DRAIN CURRENT vs CASE TEMPERATURE

IRFBC40, IRFBC42

Typical Performance Curves Unless Otherwise Specified (Continued)

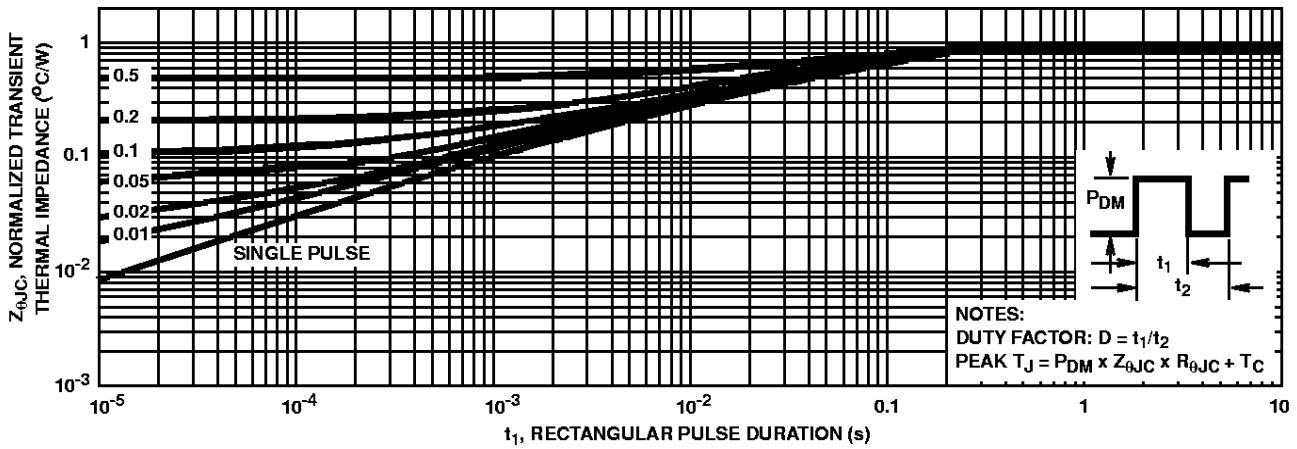

FIGURE 3. NORMALIZED MAXIMUM TRANSIENT THERMAL IMPEDANCE

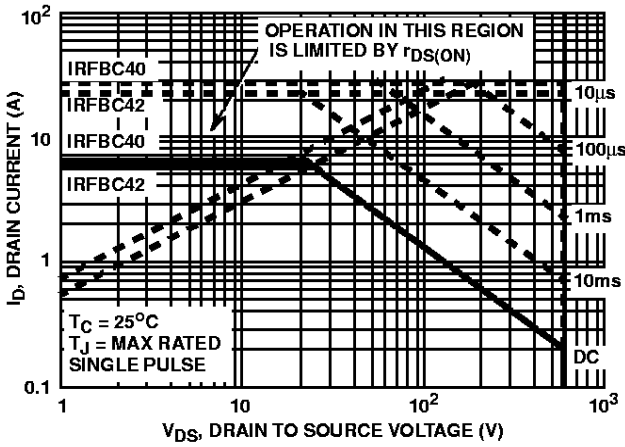

FIGURE 4. FORWARD BIAS SAFE OPERATING AREA

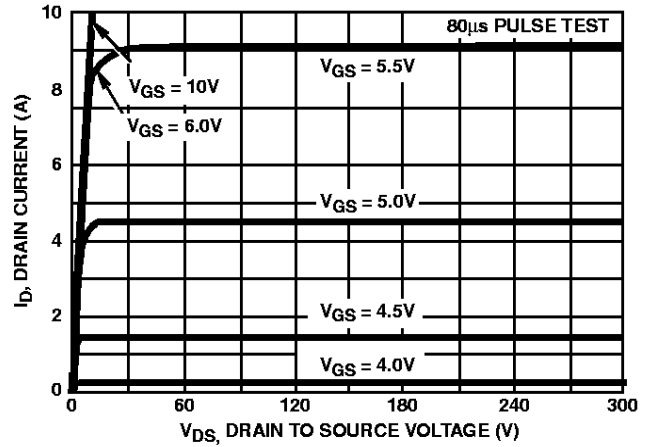

FIGURE 5. OUTPUT CHARACTERISTICS

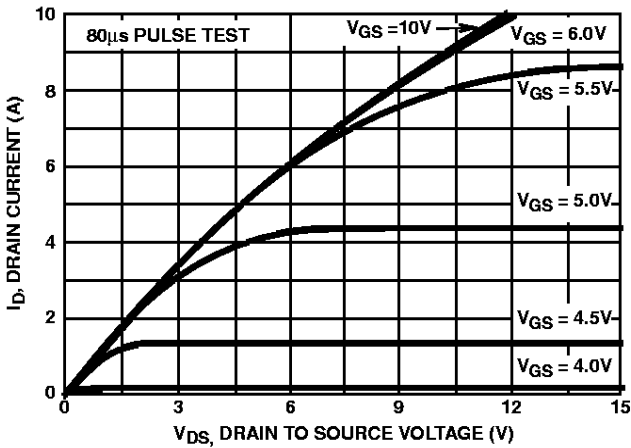

FIGURE 6. SATURATION CHARACTERISTICS

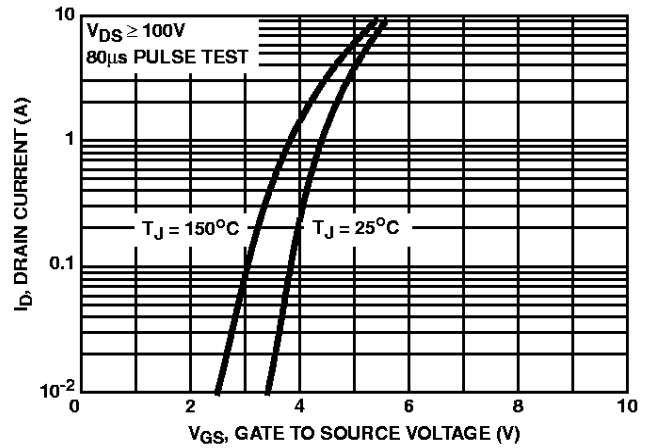

FIGURE 7. TRANSFER CHARACTERISTICS

Typical Performance Curves Unless Otherwise Specified (Continued)

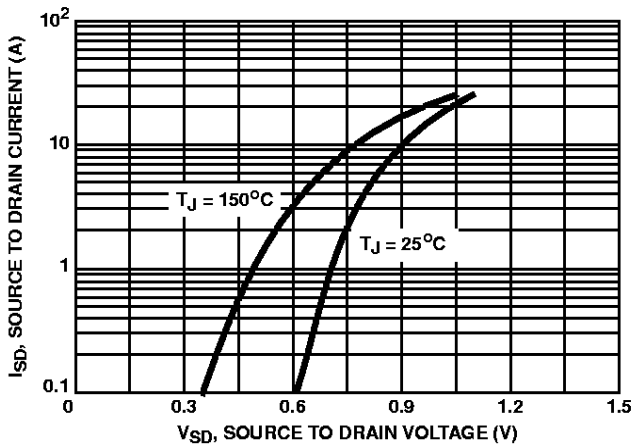

FIGURE 8. SOURCE TO DRAIN DIODE VOLTAGE

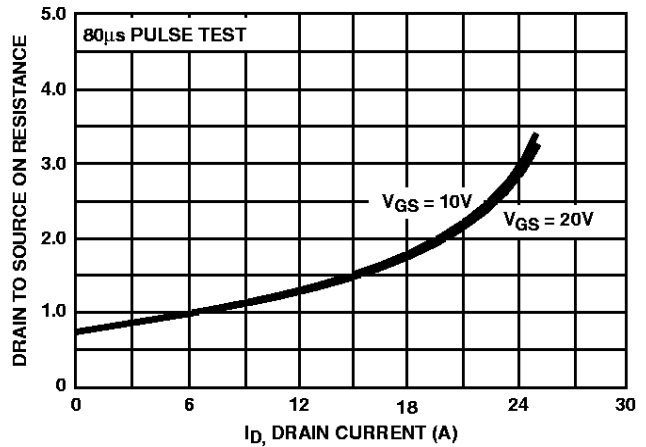

FIGURE 9. DRAIN TO SOURCE ON RESISTANCE vs GATE VOLTAGE AND DRAIN CURRENT

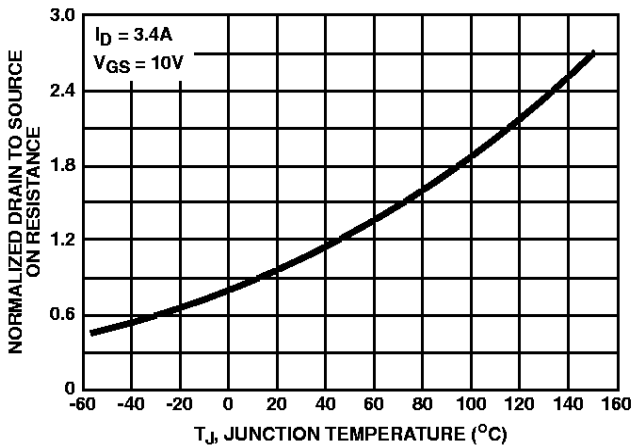

FIGURE 10. NORMALIZED DRAIN TO SOURCE ON RESISTANCE vs JUNCTION TEMPERATURE

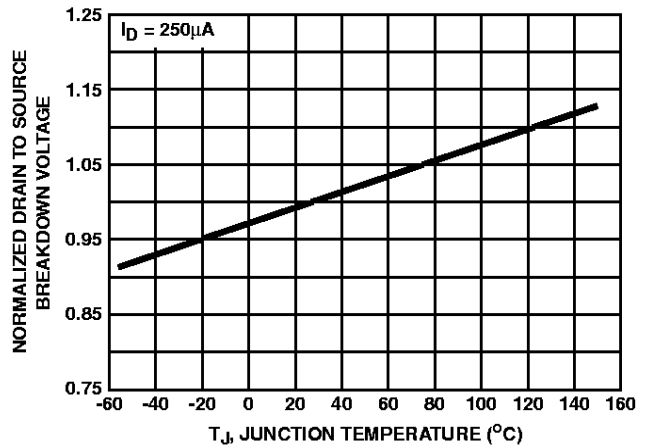

FIGURE 11. NORMALIZED DRAIN TO SOURCE BREAKDOWN VOLTAGE vs JUNCTION TEMPERATURE

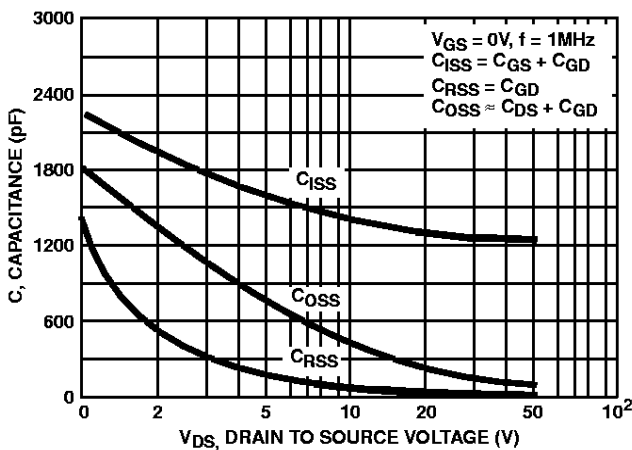

FIGURE 12. CAPACITANCE vs DRAIN TO SOURCE VOLTAGE

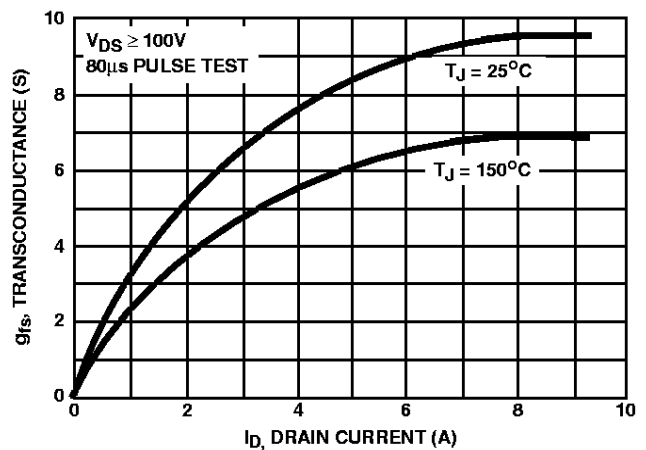

FIGURE 13. TRANSCONDUCTANCE vs DRAIN CURRENT

IRFBC40, IRFBC42

Typical Performance Curves Unless Otherwise Specified (Continued)

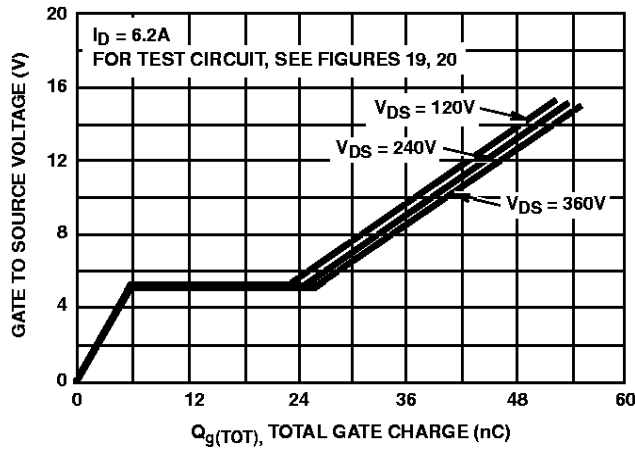

FIGURE 14. GATE TO SOURCE VOLTAGE vs GATE CHARGE

Test Circuits and Waveforms

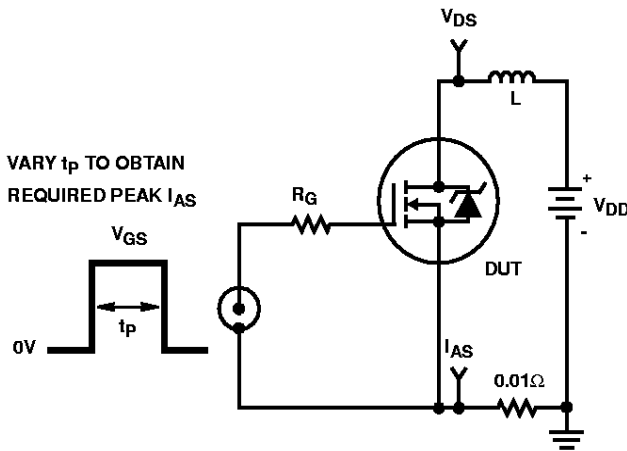

FIGURE 15. UNCLAMPED ENERGY TEST CIRCUIT

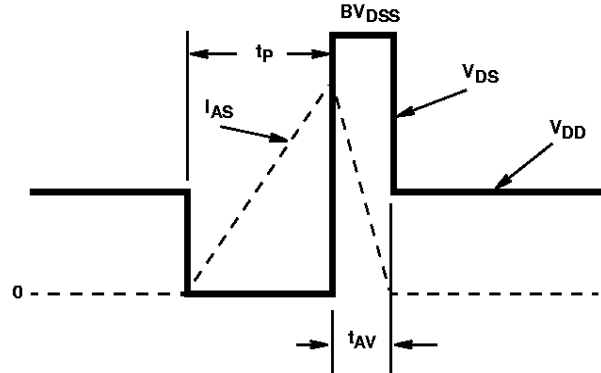

FIGURE 16. UNCLAMPED ENERGY WAVEFORMS

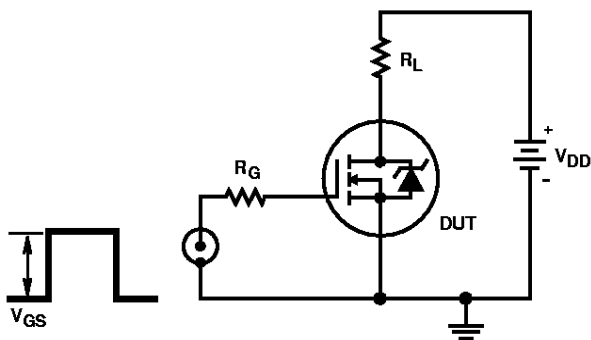

FIGURE 17. SWITCHING TIME TEST CIRCUIT

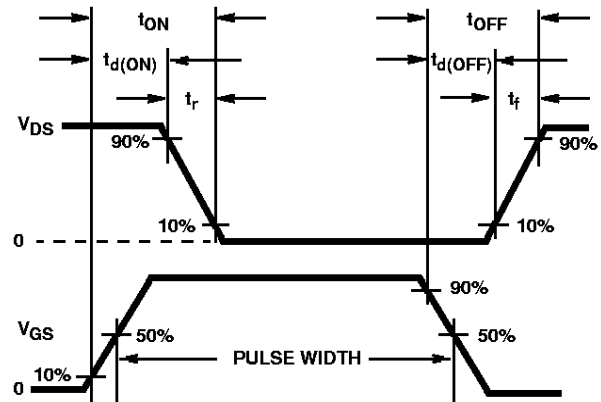

FIGURE 18. RESISTIVE SWITCHING WAVEFORMS

Test Circuits and Waveforms (Continued)

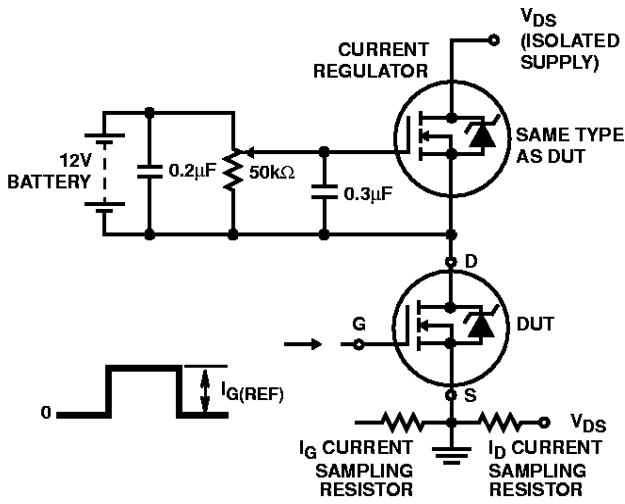

FIGURE 19. GATE CHARGE TEST CIRCUIT

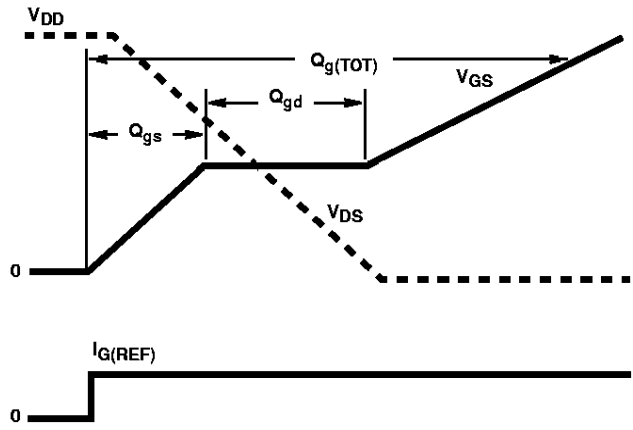

FIGURE 20. GATE CHARGE WAVEFORMS