

BLP5LA55S

Power LDMOS transistor

Rev. 4 — 12 January 2023

AMPLEON

Product data sheet

1. Product profile

1.1 General description

This 13.6 V 55 W device is designed for land mobile radio (LMR) applications supporting the frequency range from HF up to 520 MHz.

Table 1. Application performance

Typical RF performance at $T_{case} = 25\text{ °C}$; in a class-AB demo circuit.

Test signal	f	I_{Dq}	V_{DS}	$P_{L(AV)}$	G_p	η_D	RL_{in}
	(MHz)	(mA)	(V)	(W)	(dB)	(%)	(dB)
CW	145 to 165	893	15.0	63	>23.0	>66.4	-7.8
	380 to 450	80	13.6	55	>20.4	>62.3	-6.3
	520	100	13.6	55	19.6	75.0	-15.3

1.2 Features and benefits

- High efficiency
- Integrated dual sided ESD protection
- Extreme ruggedness 65 : 1
- High power gain
- Excellent reliability
- Wideband
- High linearity
- For RoHS compliance see the product details on the Ampleon website

1.3 Applications

- TETRA, SSB and LTE mobile radio applications in VHF and UHF bands
- Wideband radio application, frequency range from 5 MHz to 30 MHz and from 30 MHz to 512 MHz

2. Pinning information

Table 2. Pinning

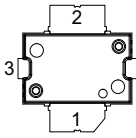
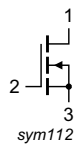
Pin	Description	Simplified outline	Graphic symbol
1	drain		
2	gate		
3	source ^[1]		

[1] Connected to flange.

3. Ordering information

Table 3. Ordering information

Package name	Orderable part number	12NC	Packing description	Min. orderable quantity (pieces)
TO-270-2F-1	BLP5LA55SZ	9349 602 92515	TR13; 500-fold; 24 mm; dry pack	500
	BLP5LA55SXY	9349 602 92538	TR7; 100-fold; 24 mm; dry pack	100

4. Limiting values

Table 4. Limiting values

In accordance with the Absolute Maximum Rating System (IEC 60134).

Symbol	Parameter	Conditions	Min	Max	Unit
V_{DS}	drain-source voltage		-	30	V
V_{GS}	gate-source voltage		-5	+13	V
T_{stg}	storage temperature		-65	+150	°C
T_j	junction temperature	^[1]	-	225	°C

[1] Continuous use at maximum temperature will affect the reliability, for details refer to the online MTF calculator.

5. Thermal characteristics

Table 5. Thermal characteristics

Symbol	Parameter	Conditions	Typ	Unit
$R_{th(j-c)}$	thermal resistance from junction to case	$T_{case} = 80\text{ °C}; V_{DS} = 13.6\text{ V}; P_L = 55\text{ W}$	0.46	K/W

6. Characteristics

Table 6. DC characteristics

$T_j = 25\text{ °C}$; unless otherwise specified.

Symbol	Parameter	Conditions	Min	Typ	Max	Unit
$V_{(BR)DSS}$	drain-source breakdown voltage	$V_{GS} = 0\text{ V}$; $I_D = 2.25\text{ mA}$	30	-	-	V
$V_{GS(th)}$	gate-source threshold voltage	$V_{DS} = 10\text{ V}$; $I_D = 225\text{ mA}$	1.5	1.9	2.5	V
I_{DSS}	drain leakage current	$V_{GS} = 0\text{ V}$; $V_{DS} = 32\text{ V}$	-	-	1.4	μA
I_{DSX}	drain cut-off current	$V_{GS} = V_{GS(th)} + 3.75\text{ V}$; $V_{DS} = 10\text{ V}$	-	38	-	A
I_{GSS}	gate leakage current	$V_{GS} = 11\text{ V}$; $V_{DS} = 0\text{ V}$	-	-	140	nA
g_{fs}	forward transconductance	$V_{DS} = 10\text{ V}$; $I_D = 11.25\text{ A}$	-	15	-	S
$R_{DS(on)}$	drain-source on-state resistance	$V_{GS} = V_{GS(th)} + 3.75\text{ V}$; $I_D = 7.88\text{ A}$	-	60	-	$\text{m}\Omega$

Table 7. AC characteristics

$T_j = 25\text{ °C}$; unless otherwise specified.

Symbol	Parameter	Conditions	Min	Typ	Max	Unit
C_{iss}	input capacitance	$V_{GS} = 0\text{ V}$; $V_{DS} = 13.6\text{ V}$; $f = 1\text{ MHz}$	-	173.5	-	pF
C_{oss}	output capacitance	$V_{GS} = 0\text{ V}$; $V_{DS} = 13.6\text{ V}$; $f = 1\text{ MHz}$	-	106.1	-	pF
C_{rss}	reverse transfer capacitance	$V_{GS} = 0\text{ V}$; $V_{DS} = 13.6\text{ V}$; $f = 1\text{ MHz}$	-	1.3	-	pF

Table 8. RF characteristics

Test signal: CW at $V_{DS} = 13.6\text{ V}$; $I_{Dq} = 100\text{ mA}$; $T_{case} = 25\text{ °C}$; unless otherwise specified; in a class-AB production board measured at frequencies of 520 MHz.

Symbol	Parameter	Conditions	Min	Typ	Max	Unit
G_p	power gain	$P_L = 55\text{ W}$	18.0	19.6	-	dB
RL_{in}	input return loss	$P_L = 55\text{ W}$	-	-15.3	-	dB
η_D	drain efficiency	$P_L = 55\text{ W}$	72.0	75.0	-	%

7. Test information

7.1 Ruggedness in class-AB operation

The BLP5LA55S is capable of withstanding a load mismatch corresponding to $VSWR = 65 : 1$ through all phases under the following conditions: $V_{DS} = 13.6\text{ V}$; $I_{Dq} = 100\text{ mA}$; $P_L = 55\text{ W}$ (CW); $f = 520\text{ MHz}$.

7.2 Test circuit

7.2.1 Test circuit $f = 145 \text{ MHz to } 165 \text{ MHz}$

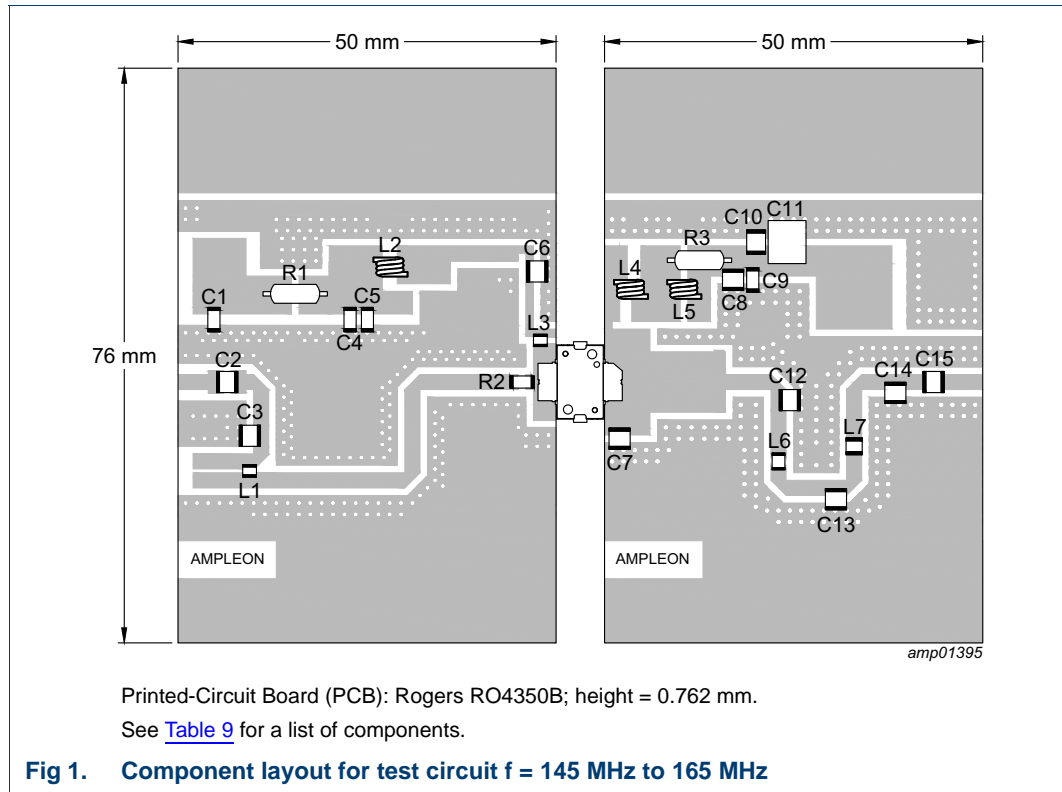

Table 9. List of components

See [Figure 1](#) for component layout.

Component	Description	Value	Remarks
C1, C5, C9	multilayer ceramic chip capacitor	100 nF	C1206C104K1RAC
C2	multilayer ceramic chip capacitor	470 pF	ATC 100B
C3	multilayer ceramic chip capacitor	43 pF	ATC 100B
C4	multilayer ceramic chip capacitor	1 μF , 25 V	GRM31MR71E105KA01L
C6	multilayer ceramic chip capacitor	390 pF	ATC 100B
C7	multilayer ceramic chip capacitor	180 pF	ATC 100B
C8	multilayer ceramic chip capacitor	1 nF	ATC 100B
C10	multilayer ceramic chip capacitor	1 μF , 50 V	GRM32RR71H105KA01L
C11	multilayer ceramic chip capacitor	10 μF , 50 V	
C12	multilayer ceramic chip capacitor	200 pF	ATC 100B
C13	multilayer ceramic chip capacitor	62 pF	ATC 100B
C14	multilayer ceramic chip capacitor	33 pF	ATC 100B
C15	multilayer ceramic chip capacitor	330 pF	ATC 100B
L1	square air core inductor	8.9 nH	0806SQ-8N9JL
L2	inductor air core	~30 nH	
L3	square air core inductor	10.2 nH	0807SQ-10NJL

Table 9. List of components ...continued
See [Figure 1](#) for component layout.

Component	Description	Value	Remarks
L4	inductor air core	~60 nH	
L5	Inductor air core	~30 nH	
L6	wire one turn	~0.3 nH	
L7	square air core inductor	16.6 nH	0908SQ-17NJL
R1	axial resistor	51.1 Ω	
R2	SMD	6.8 Ω	Size: 1206 (3216 metric)
R3	axial resistor	68.1 Ω	

7.2.2 Test circuit f = 380 MHz to 450 MHz

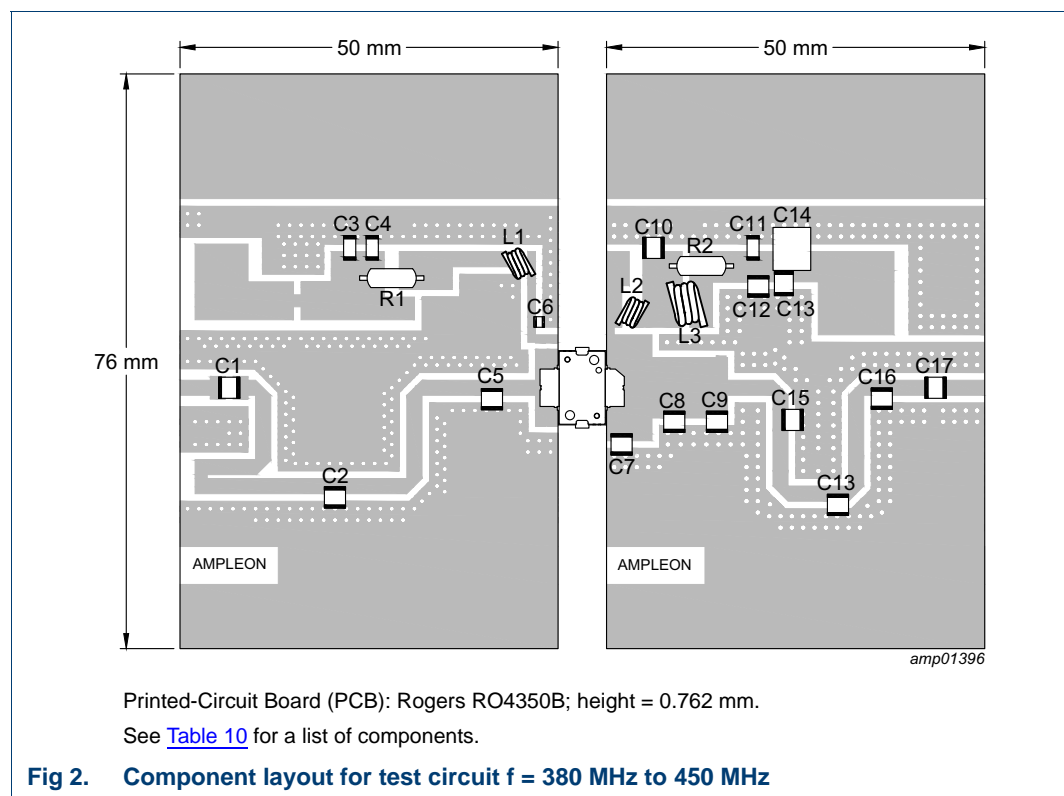

Table 10. List of components
See [Figure 2](#) for component layout.

Component	Description	Value	Remarks
C1	multilayer ceramic chip capacitor	240 pF	ATC 100B
C2	multilayer ceramic chip capacitor	18 pF	ATC 100B
C3	multilayer ceramic chip capacitor	1 μF, 25 V	GRM31MR71E105KA01L
C4, C11	multilayer ceramic chip capacitor	100 nF	C1206C104K1RAC
C5	multilayer ceramic chip capacitor	75 pF	ATC 100B
C6	multilayer ceramic chip capacitor	120 pF	ATC 600F
C7	multilayer ceramic chip capacitor	62 pF	ATC 800B

Table 10. List of components ...continued
 See [Figure 2](#) for component layout.

Component	Description	Value	Remarks
C8	multilayer ceramic chip capacitor	51 pF	ATC 800B
C9	multilayer ceramic chip capacitor	43 pF	ATC 800B
C10	multilayer ceramic chip capacitor	390 pF	ATC 100B
C12	multilayer ceramic chip capacitor	1 nF	ATC 100B
C13	multilayer ceramic chip capacitor	1 μ F, 50 V	GRM32RR71H105KA01L
C14	multilayer ceramic chip capacitor	10 μ F, 50 V	
C15	multilayer ceramic chip capacitor	27 pF	ATC 100B
C16	multilayer ceramic chip capacitor	7.5 pF	ATC 100B
C17	multilayer ceramic chip capacitor	130 pF	ATC 100B
L1	inductor air core	~30 nH	
L2	inductor air core	~60 nH	
L3	inductor air core	~30 nH	
R1	axial resistor	68 Ω	
R2	axial resistor	10 Ω	

7.2.3 Test circuit f = 520 MHz

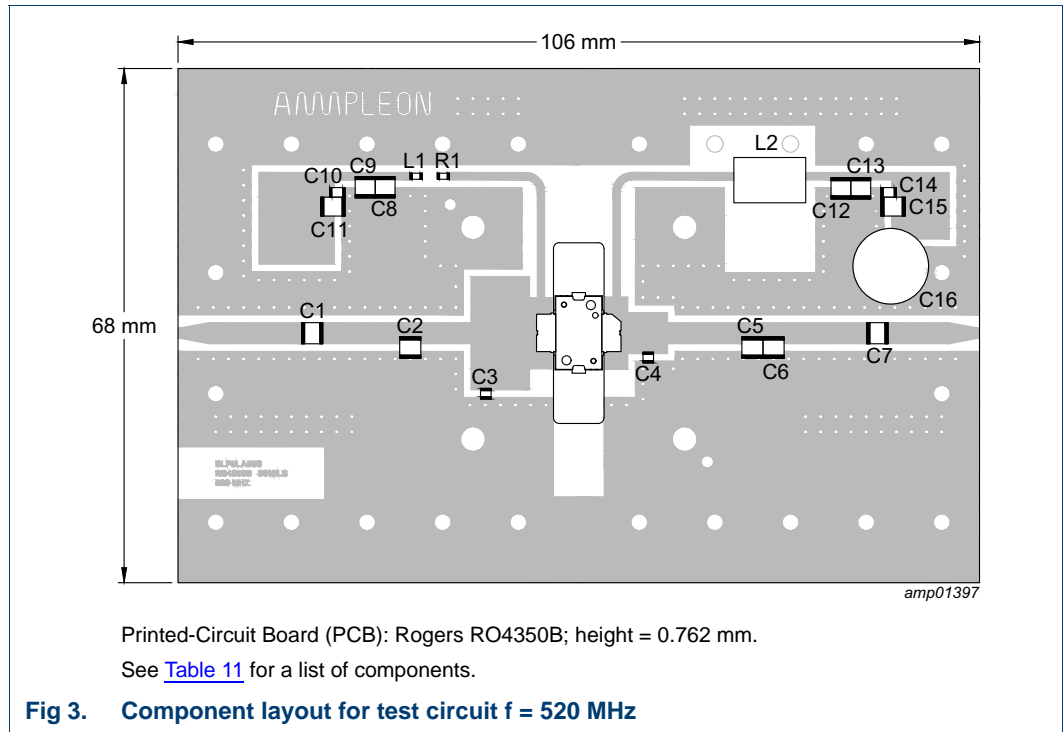

Table 11. List of components

See [Figure 3](#) for component layout.

Component	Description	Value	Remarks
C1	multilayer ceramic chip capacitor	6.8 pF	ATC 100B
C2	multilayer ceramic chip capacitor	20 pF	ATC 100B
C3	multilayer ceramic chip capacitor	39 pF	ATC 100A
C4	multilayer ceramic chip capacitor	43 pF	ATC 100A
C5	multilayer ceramic chip capacitor	6.2 pF	ATC 100B
C6	multilayer ceramic chip capacitor	10 pF	ATC 100B
C7	multilayer ceramic chip capacitor	15 pF	ATC 100B
C8, C12	multilayer ceramic chip capacitor	22 pF	ATC 100B
C9, C13	multilayer ceramic chip capacitor	1 nF	ATC 100B
C10, C14	multilayer ceramic chip capacitor	0.1 μF	GRM21BR71H104KA01L
C11, C15	multilayer ceramic chip capacitor	1 μF	GRM32RR71H105KA01L
C16	Electrolytic capacitor	1000 μF, 63 V	
L1	Wire wound inductor	43 nH	LQW18AN43NG80
L2	Inductor air core	~53 nH	
R1	SMD	10 Ω	Size: 0603 (1608 metric)

7.3 Graphical data

7.3.1 1-Tone CW measurements (f = 145 MHz to 165 MHz)

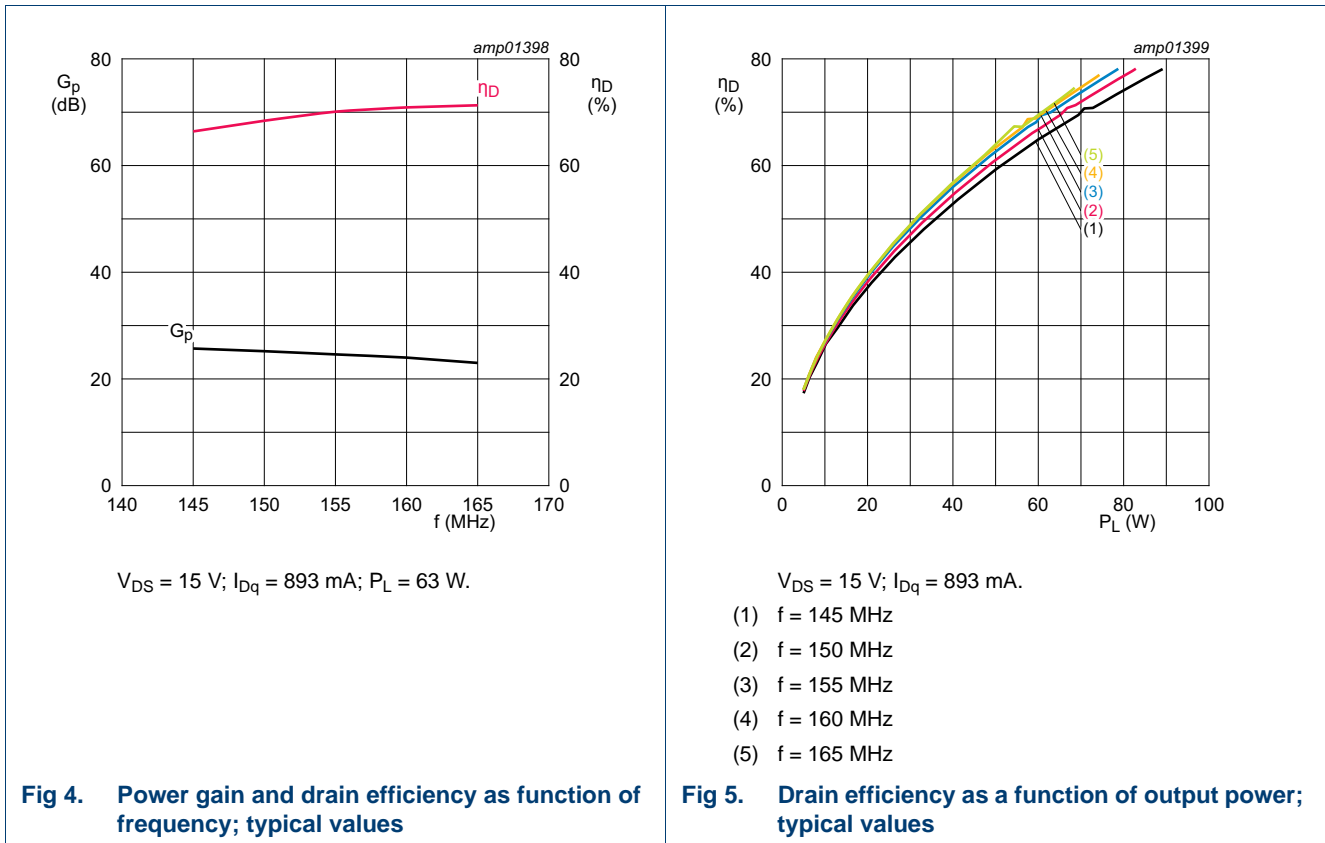

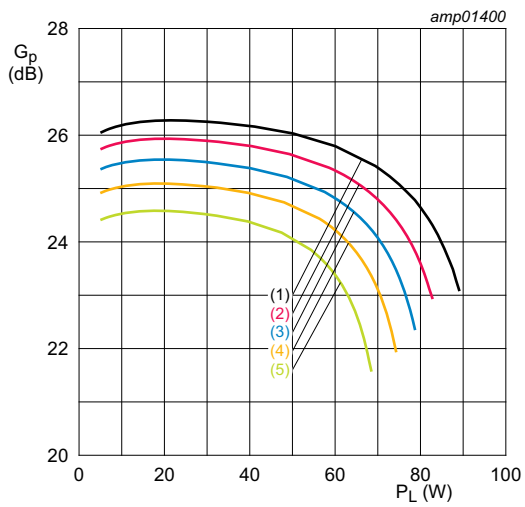

$V_{DS} = 15$ V; $I_{Dq} = 893$ mA.

- (1) $f = 145$ MHz
- (2) $f = 150$ MHz
- (3) $f = 155$ MHz
- (4) $f = 160$ MHz
- (5) $f = 165$ MHz

Fig 6. Power gain as a function of output power; typical values

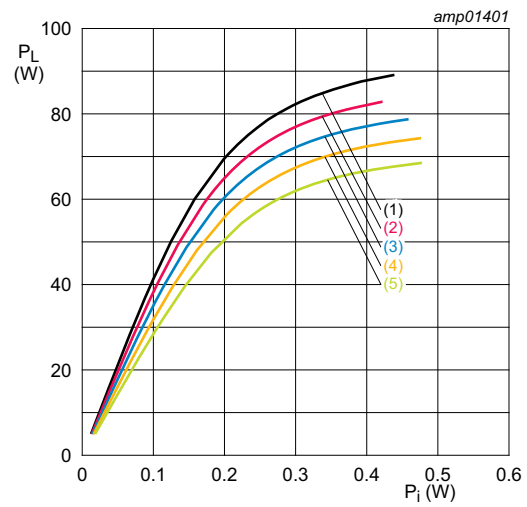

$V_{DS} = 15$ V; $I_{Dq} = 893$ mA.

- (1) $f = 145$ MHz
- (2) $f = 150$ MHz
- (3) $f = 155$ MHz
- (4) $f = 160$ MHz
- (5) $f = 165$ MHz

Fig 7. Output power as a function of input power; typical values

7.3.2 2-Tone CW measurements (f = 145 MHz to 165 MHz)

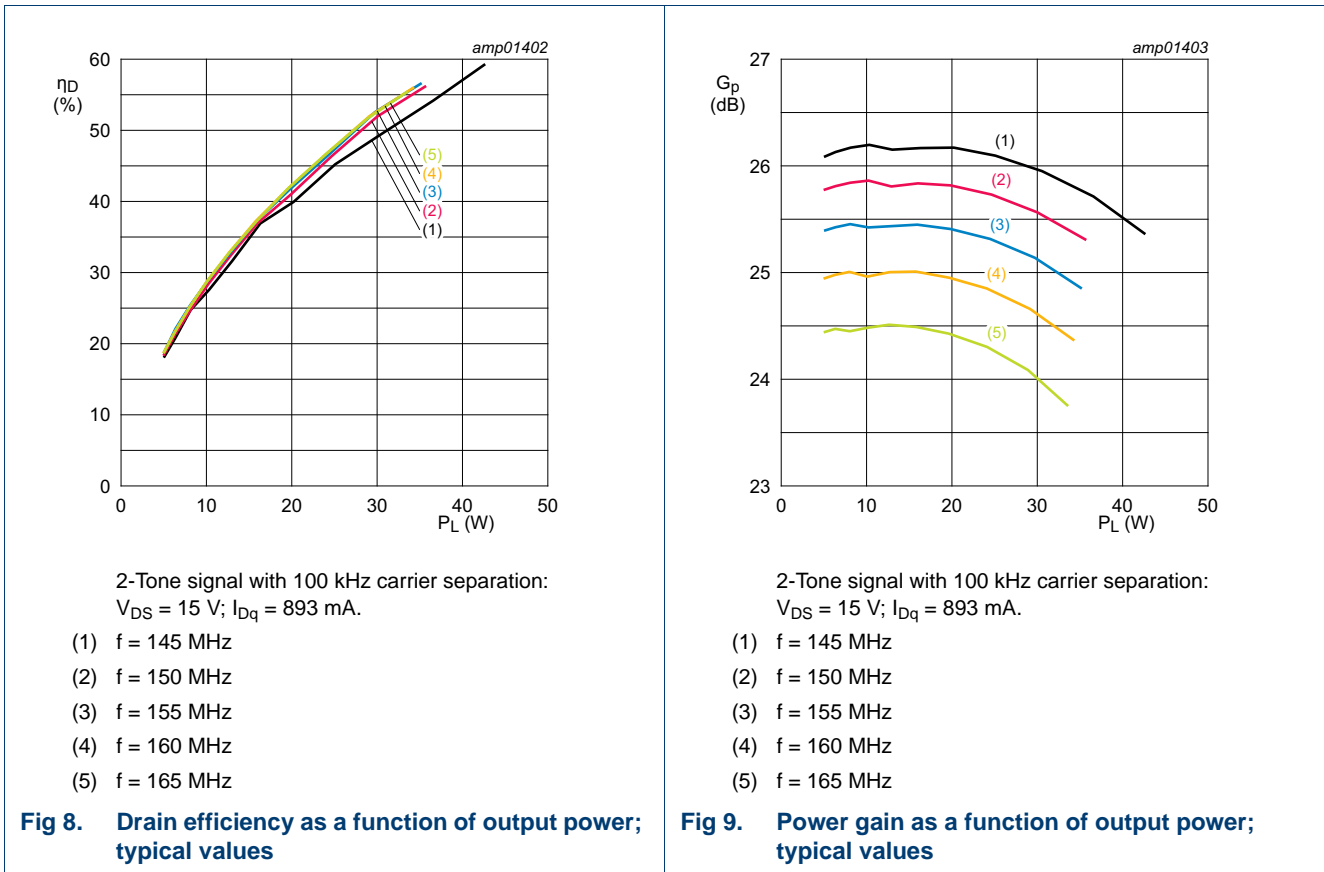

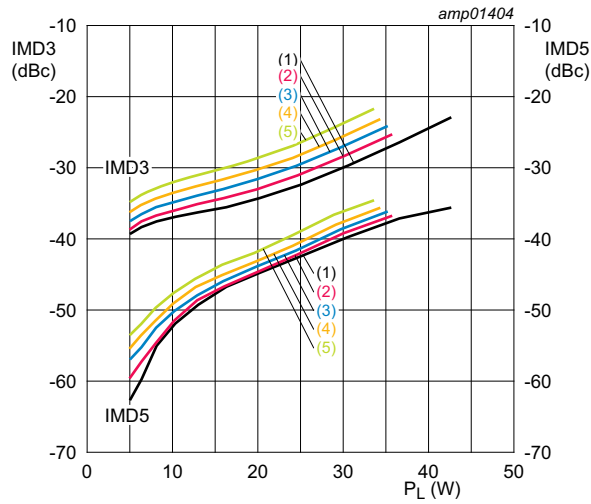

2-Tone signal with 100 kHz carrier separation: $V_{DS} = 15\text{ V}$; $I_{Dq} = 893\text{ mA}$.

- (1) $f = 145\text{ MHz}$
- (2) $f = 150\text{ MHz}$
- (3) $f = 155\text{ MHz}$
- (4) $f = 160\text{ MHz}$
- (5) $f = 165\text{ MHz}$

Fig 10. Intermodulation distortion as a function of output power; typical values

7.3.3 1-Tone CW measurements (f = 380 MHz to 450 MHz)

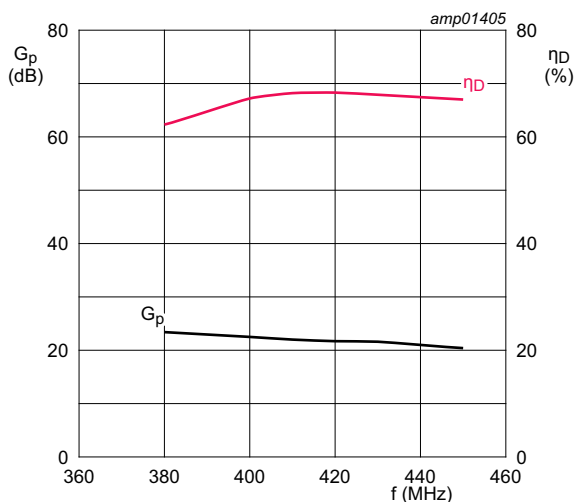

$V_{DS} = 13.6 \text{ V}; I_{Dq} = 80 \text{ mA}; P_L = 55 \text{ W}.$

Fig 11. Power gain and drain efficiency as function of frequency; typical values

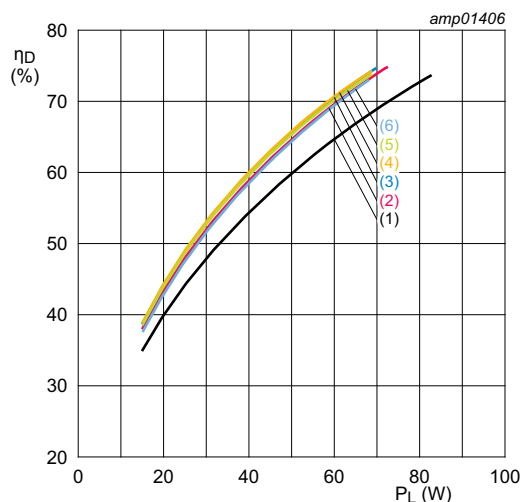

$V_{DS} = 13.6 \text{ V}; I_{Dq} = 80 \text{ mA}.$

- (1) f = 380 MHz
- (2) f = 400 MHz
- (3) f = 410 MHz
- (4) f = 420 MHz
- (5) f = 430 MHz
- (6) f = 450 MHz

Fig 12. Drain efficiency as a function of output power; typical values

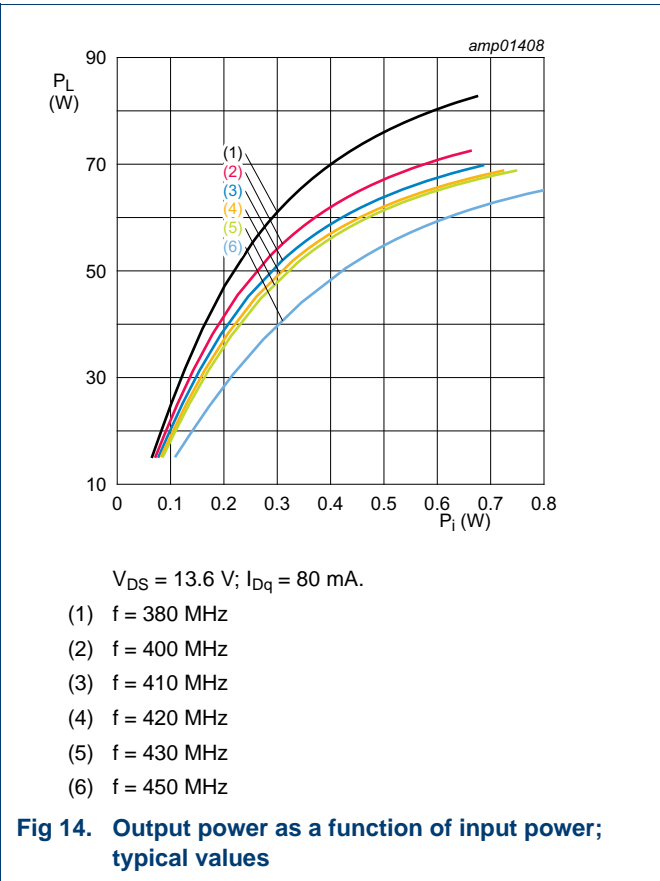
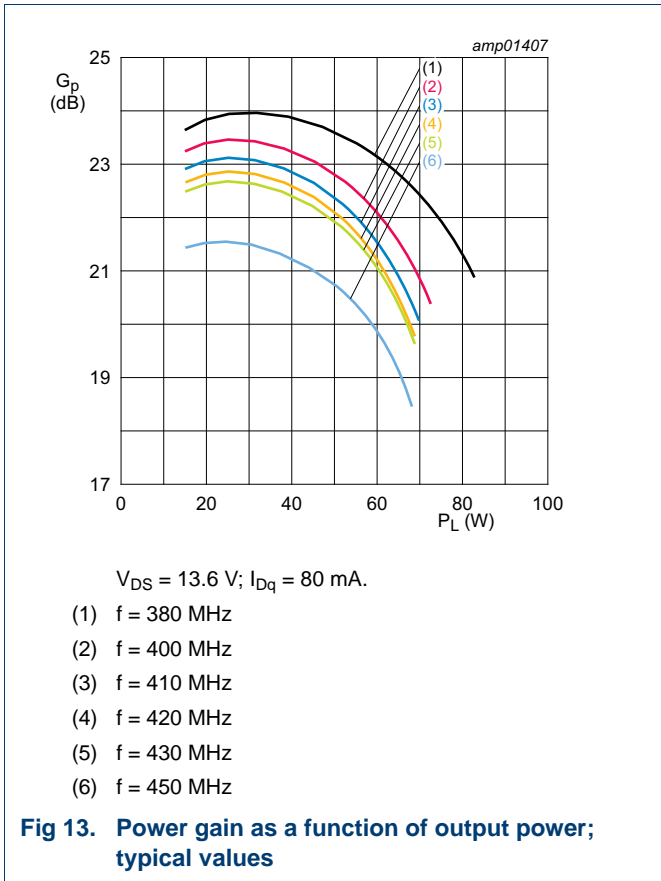

7.3.4 1-Tone CW measurements (f = 520 MHz)

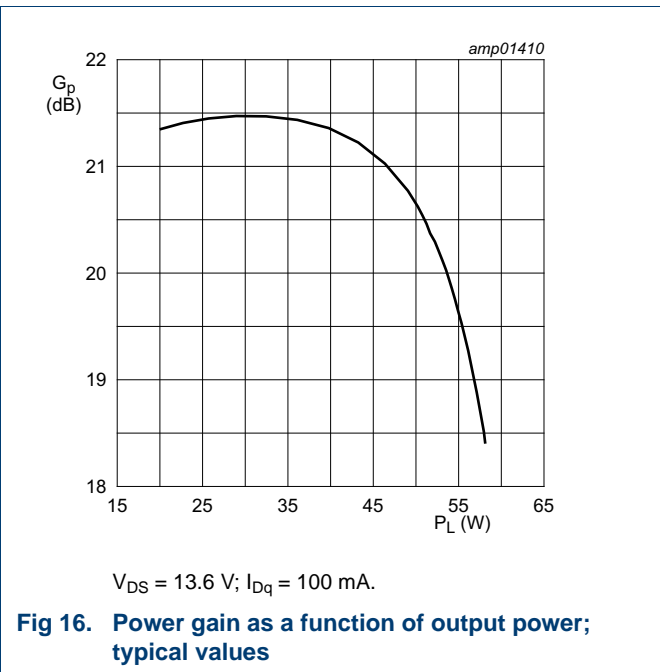
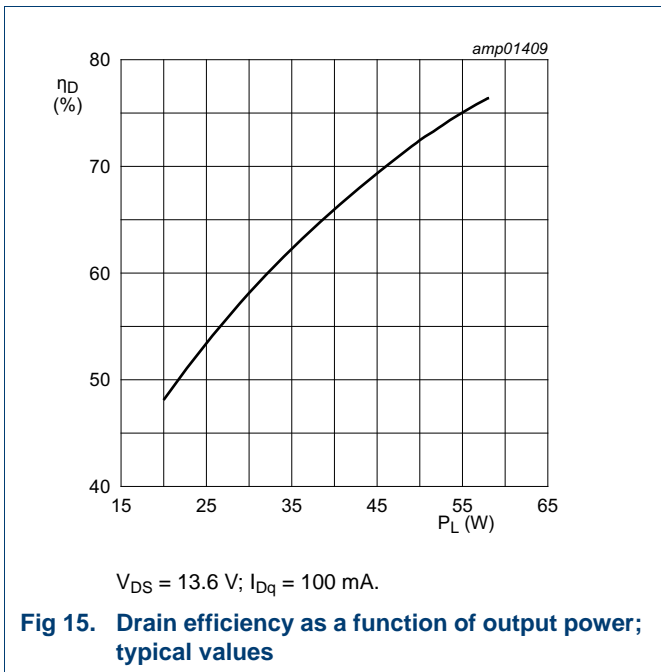

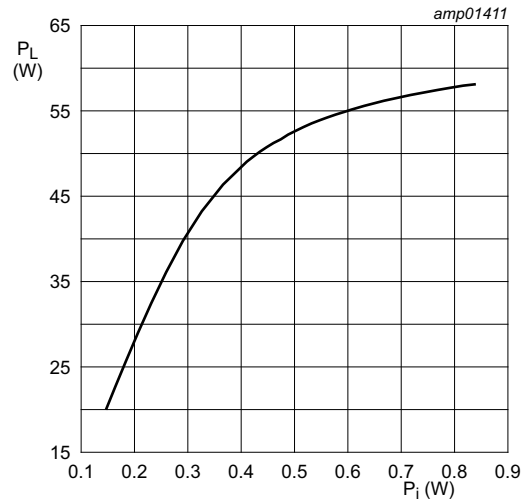

V_{DS} = 13.6 V; I_{Dq} = 100 mA.

Fig 17. Output power as a function of input power; typical values

8. Package outline

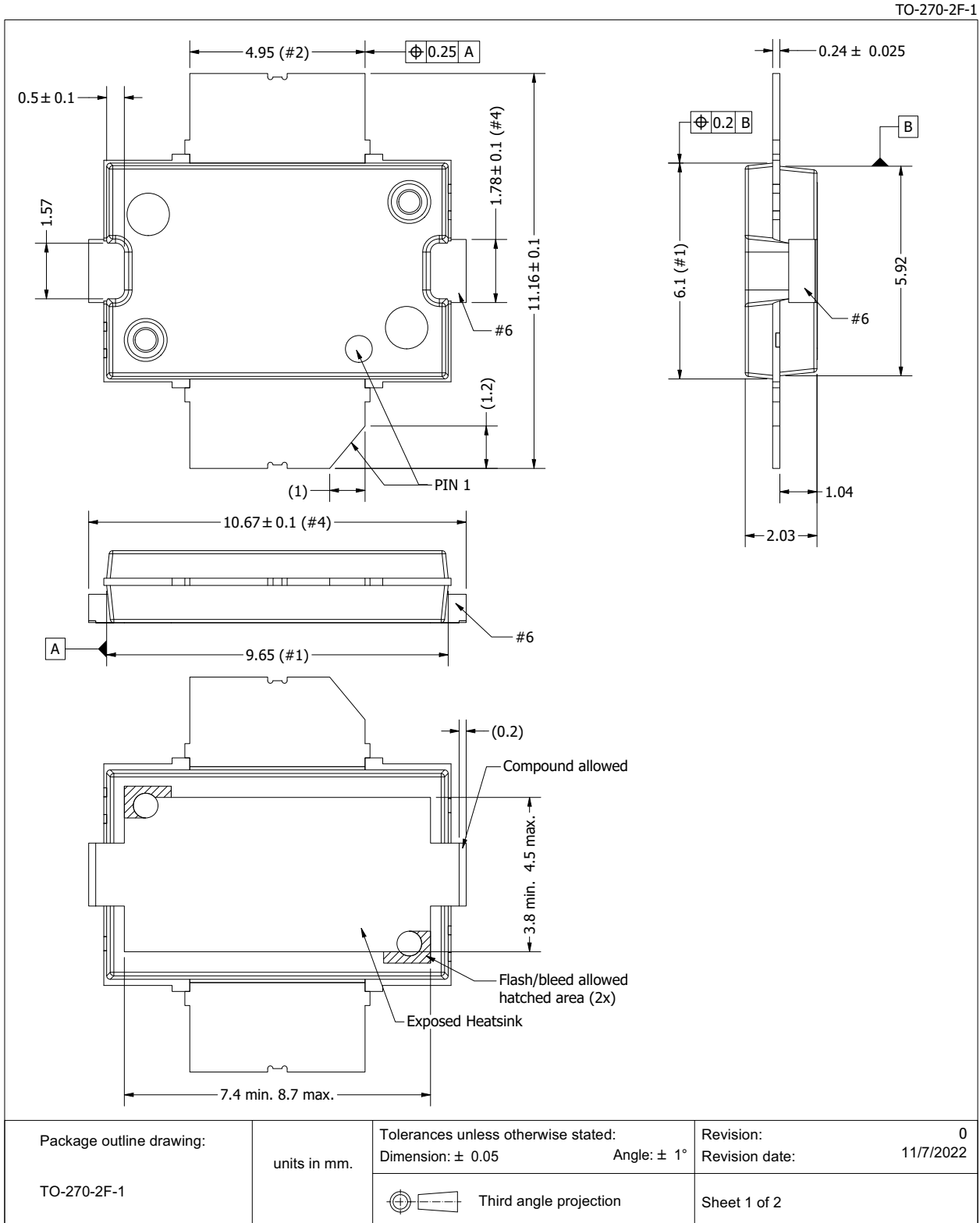
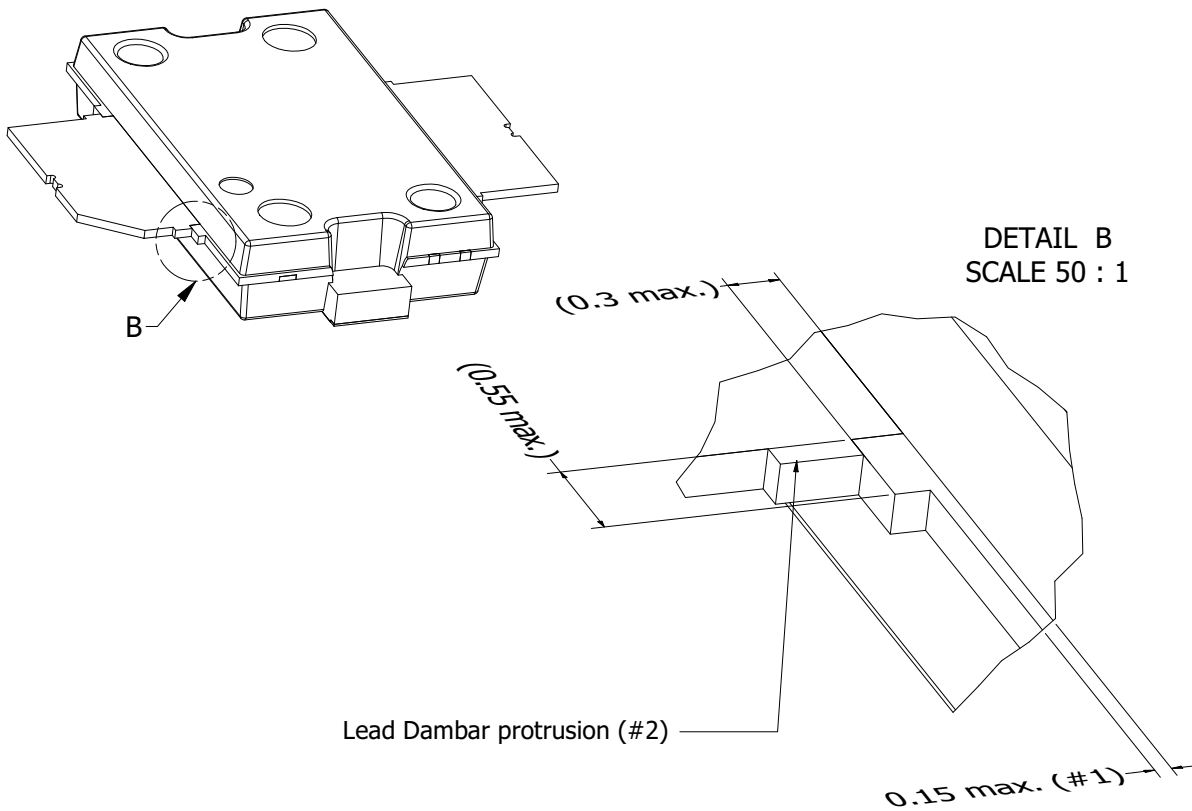

Fig 18. Package outline TO-270-2F-1 (sheet 1 of 2)

TO-270-2F-1

Drawing Notes	
Items	Description
(1)	Dimensions are excluding mold protrusion. The mold protrusion is maximum 0.15 mm per side. See also detail B. In the dambar area max. protrusion is 0.55 mm. max. in length and 0.3 mm. max. in width (4x). See also detail B.
(2)	The lead dambar (metal) protrusions are not included. Add 0.14 mm max to the total lead dimension at the dambar location.
(3)	The leads and exposed heatsink are plated with matte Tin (Sn).
(4)	Dimensions (Heatsink ears) 10,67 and 1,78 do not include mouldprotrusion. Overall Max. dimensions incl. mould protrusions is 10.92 mm. (max.) and 2.03 mm. (max.).
(5)	Lead coplanarity over the leads is 0,1 mm. maximum.
(6)	Surfaces may remain unplated (not solderable surfaces).



Package outline drawing:	units in mm.	Tolerances unless otherwise stated:	Revision: 0
TO-270-2F-1		Dimension: ± 0.05 Angle: $\pm 1^\circ$	Revision date: 11/7/2022
		Third angle projection	Sheet 2 of 2

Fig 19. Package outline TO-270-2F-1 (sheet 2 of 2)

9. Handling information

CAUTION



This device is sensitive to ElectroStatic Discharge (ESD). Observe precautions for handling electrostatic sensitive devices.
Such precautions are described in the *ANSI/ESD S20.20*, *IEC/ST 61340-5*, *JESD625-A* or equivalent standards.

Table 12. ESD sensitivity

ESD model	Class
Charged Device Model (CDM); According to ANSI/ESDA/JEDEC standard JS-002	C2A [1]
Human Body Model (HBM); According to ANSI/ESDA/JEDEC standard JS-001	2 [2]

[1] CDM classification C2A is granted to any part that passes after exposure to an ESD pulse of 500 V.

[2] HBM classification 2 is granted to any part that passes after exposure to an ESD pulse of 2000 V.

10. Abbreviations

Table 13. Abbreviations

Acronym	Description
CW	Continuous Wave
ESD	ElectroStatic Discharge
HF	High Frequency
LDMOS	Laterally Diffused Metal-Oxide Semiconductor
LTE	Long Term Evolution
MTF	Median Time to Failure
RoHS	Restriction of Hazardous Substances
SSB	Single Side-Band
SMD	Surface Mounted Device
TETRA	TErrestrial Trunked Radio
UHF	Ultra High Frequency
VHF	Very High Frequency
VSWR	Voltage Standing Wave Ratio

11. Revision history

Table 14. Revision history

Document ID	Release date	Data sheet status	Change notice	Supersedes
BLP5LA55S v.4	20230112	Product data sheet	-	BLP5LA55S v.3
Modifications:	<ul style="list-style-type: none"> • Table 3 on page 2: package name changed from SOT1482-1 to TO-270-2F-1 • Table 5 on page 2: value changed from 0.617 K/W to 0.46 K/W • Table 8 on page 3: clerical error; corrected $V_{DS} = 32\text{ V}$ to $V_{DS} = 13.6\text{ V}$ in table description • Section 8 on page 15: package outline drawing changed from SOT1482-1 to TO-270-2F-1 • Section 12 on page 19: updated section 			
BLP5LA55S v.3	20210716	Product data sheet	-	BLP5LA55S v.2
BLP5LA55S v.2	20210401	Product data sheet	-	BLP5LA55S v.1
BLP5LA55S v.1	20210104	Product data sheet	-	-

12. Legal information

12.1 Data sheet status

Document status ^{[1][2]}	Product status ^[3]	Definition
Objective [short] data sheet	Development	This document contains data from the objective specification for product development.
Preliminary [short] data sheet	Qualification	This document contains data from the preliminary specification.
Product [short] data sheet	Production	This document contains the product specification.

[1] Please consult the most recently issued document before initiating or completing a design.

[2] The term 'short data sheet' is explained in section "Definitions".

[3] The product status of device(s) described in this document may have changed since this document was published and may differ in case of multiple devices. The latest product status information is available on the Internet at URL <http://www.ampleon.com>.

12.2 Definitions

Draft — The document is a draft version only. The content is still under internal review and subject to formal approval, which may result in modifications or additions. Ampleon does not give any representations or warranties as to the accuracy or completeness of information included herein and shall have no liability for the consequences of use of such information.

Short data sheet — A short data sheet is an extract from a full data sheet with the same product type number(s) and title. A short data sheet is intended for quick reference only and should not be relied upon to contain detailed and full information. For detailed and full information see the relevant full data sheet, which is available on request via the local Ampleon sales office. In case of any inconsistency or conflict with the short data sheet, the full data sheet shall prevail.

Product specification — The information and data provided in a Product data sheet shall define the specification of the product as agreed between Ampleon and its customer, unless Ampleon and customer have explicitly agreed otherwise in writing. An agreement according to which the functions and qualities of Ampleon products exceed those described in the Product data sheet is invalid.

Right to make changes — Ampleon reserves the right to change information including but without limitation specifications and product descriptions published in this document at any time and without notice. This document supersedes and replaces all information regarding these products supplied prior to the publication hereof.

Suitability for use — Ampleon products are not designed, authorized or warranted to be suitable for use in life support, life-critical or safety-critical systems or equipment, nor in applications where failure or malfunction of an Ampleon product can reasonably be expected to result in personal injury, death or severe property or environmental damage. Insofar as a customer or another party nevertheless uses Ampleon products unlawfully for such purposes, Ampleon and its suppliers are not liable for any damages.

Applications — Applications that are described herein for any of these products are for illustrative purposes only. Ampleon makes no representation or warranty that such applications will be suitable for the specified use without further testing or modification.

Customers are responsible for the design and operation of their applications and products using Ampleon products, and Ampleon is not liable for any assistance with applications or customer product design. It is customer's sole responsibility to determine whether the Ampleon product is suitable and fit for the customer's applications and products planned, as well as for the planned application and use of customer's third party customer(s). Customers shall provide appropriate design and operating safeguards to minimize the risks associated with their applications and products.

Ampleon is not liable related to any default, damage, costs or problem which is based on any weakness or default in the customer's applications or products, or the application or use by customer's third party customer(s). Customer is responsible for and shall do all necessary testing for the customer's applications and products using Ampleon products in order to avoid a default of the applications and the products or of the application or use by customer's third party customer(s). Ampleon is not liable in this respect.

Limiting values — Stress above one or more limiting values (as defined in the Absolute Maximum Ratings System of IEC 60134) will cause permanent damage to the device. Limiting values are stress ratings only and (proper) operation of the device at these or any other conditions above those given in the Recommended operating conditions section (if present) or the Characteristics sections of this document is not guaranteed. Constant or repeated exposure to limiting values will permanently and irreversibly affect the quality and reliability of the device.

Terms and conditions of commercial sale — Ampleon products are sold subject to the general terms and conditions of commercial sale, as published at <http://www.ampleon.com/terms>, unless otherwise agreed in a valid written individual agreement. In the event of signing an individual agreement the terms and conditions of the respective agreement shall apply. Ampleon hereby expressly objects to and rejects the validity of customer's terms and conditions regarding the purchase of Ampleon products by customer.

12.3 Disclaimers

Maturity — After the relevant product(s) have passed the Release Gate in Ampleon's release process, Ampleon will confirm the final version in writing.

Limited warranty and liability — Ampleon uses its best efforts to keep the information in this document accurate and reliable. However, Ampleon gives no representations or warranties, expressed or implied, as to the accuracy or completeness of such information and assumes no liability for the consequences of the use of such information. Ampleon is not liable for content provided by an external information source.

In no event and irrespective of the legal basis (contract, tort (including negligence) statutory liability, misrepresentation, indemnity or any other area of law) shall Ampleon be liable for any indirect, incidental, punitive, special or consequential damages (including but without limitation loss of profit or revenue, loss of use or loss of production, loss of data, cost of capital, cost of substitute goods, property damage external to the Ampleon products and any damage, expenditure or loss arising out of such damage, business interruption, costs related to the removal or replacement of any products or rework charges) or any of the foregoing suffered by any third party.

Notwithstanding any damages that customer might incur for any reason whatsoever, Ampleon's aggregate and cumulative liability towards customer for the products described herein shall be limited in accordance with the *Terms and conditions of commercial sale* of Ampleon.

No offer to sell or license — Nothing in this document may be interpreted or construed as an offer to sell products that is open for acceptance or the grant, conveyance or implication of any license under any copyrights, patents or other industrial or intellectual property rights.

Export control — This document as well as the item(s) described herein may be subject to export control regulations. Export might require a prior authorization from competent authorities.

Non-automotive qualified products — Unless this data sheet expressly states that this specific Ampleon product is automotive qualified, the product is not suitable for automotive use. It is neither qualified nor tested in accordance with automotive testing or application requirements. Ampleon is not liable for inclusion and/or use of non-automotive qualified products in automotive equipment or applications.

In the event that customer breaches this and uses the products for design and use in automotive applications in accordance with automotive specifications and standards, (a) Ampleon gives no warranty, representation

or other guarantees of any kind with respect to such automotive applications, use and specifications, and (b) such use is solely and exclusively at customer's own risk, and (c) customer fully indemnifies Ampleon against any and all liability, damages or failed product claims, including against third parties, arising out of customer's design and use of the product for automotive applications.

Translations — A non-English (translated) version of a document is for reference only. The English version shall prevail in case of any discrepancy between the translated and English versions.

12.4 Trademarks

Notice: All referenced brands, product names, service names and trademarks are the property of their respective owners.

13. Contact information

For more information, please visit: <http://www.ampleon.com>

For sales office addresses, please visit: <http://www.ampleon.com/sales>

14. Contents

1 **Product profile** 1

1.1 General description 1

1.2 Features and benefits 1

1.3 Applications 1

2 **Pinning information** 2

3 **Ordering information** 2

4 **Limiting values** 2

5 **Thermal characteristics** 2

6 **Characteristics** 3

7 **Test information** 3

7.1 Ruggedness in class-AB operation 3

7.2 Test circuit. 4

7.2.1 Test circuit f = 145 MHz to 165 MHz 4

7.2.2 Test circuit f = 380 MHz to 450 MHz 5

7.2.3 Test circuit f = 520 MHz 7

7.3 Graphical data 8

7.3.1 1-Tone CW measurements (f = 145 MHz to 165 MHz) 8

7.3.2 2-Tone CW measurements (f = 145 MHz to 165 MHz) 10

7.3.3 1-Tone CW measurements (f = 380 MHz to 450 MHz) 12

7.3.4 1-Tone CW measurements (f = 520 MHz) 13

8 **Package outline** 15

9 **Handling information** 17

10 **Abbreviations** 17

11 **Revision history** 18

12 **Legal information** 19

12.1 Data sheet status 19

12.2 Definitions 19

12.3 Disclaimers 19

12.4 Trademarks 20

13 **Contact information** 20

14 **Contents** 21

Please be aware that important notices concerning this document and the product(s) described herein, have been included in section 'Legal information'.

© Ampleon Netherlands B.V. 2023. All rights reserved.

For more information, please visit: <http://www.ampleon.com>
 For sales office addresses, please visit: <http://www.ampleon.com/sales>

Date of release: 12 January 2023
 Document identifier: BLP5LA55S