

PLUG P/N	CKT	DIM "A"	DIM "B"	DIM "C"	DIM "D"
1727673002	2	5.40	5.80	10.80	4.95
1727673004	4	9.60	10.00	15.00	4.95
1727673006	6	13.80	14.20	19.20	4.95
1727673008	8	18.00	18.40	23.40	4.95
1727673010	10	22.20	22.60	27.60	12.95
1727673012	12	26.40	26.80	31.80	12.95
1727673014	14	30.60	31.00	36.00	12.95
1727673016	16	34.80	35.20	40.20	12.95
1727673018	18	39.00	39.40	44.40	20.95

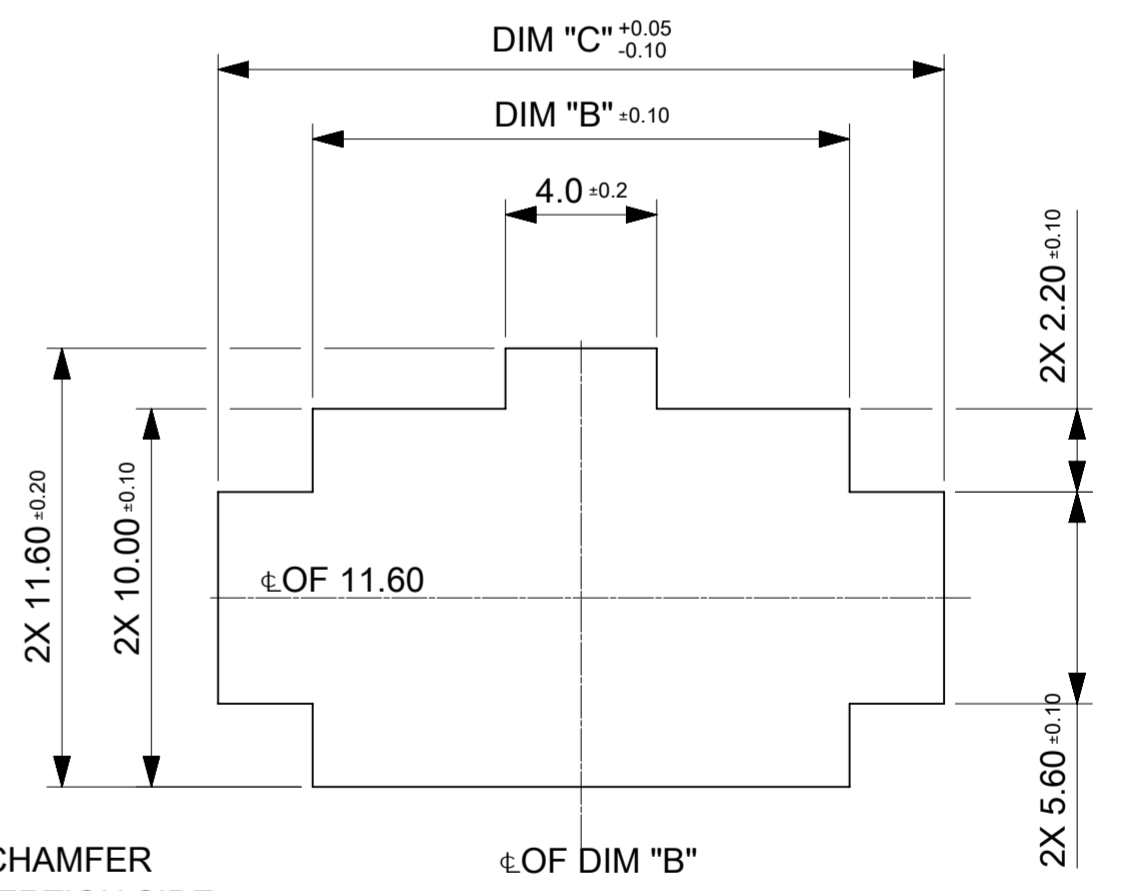
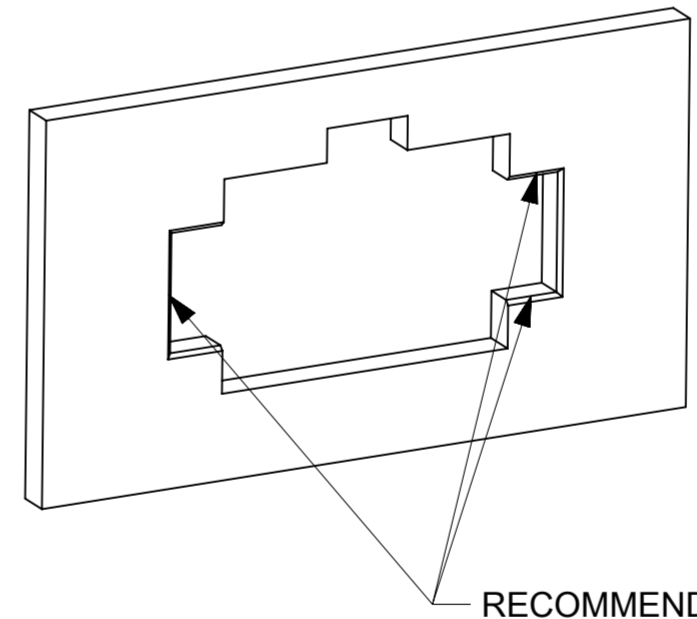
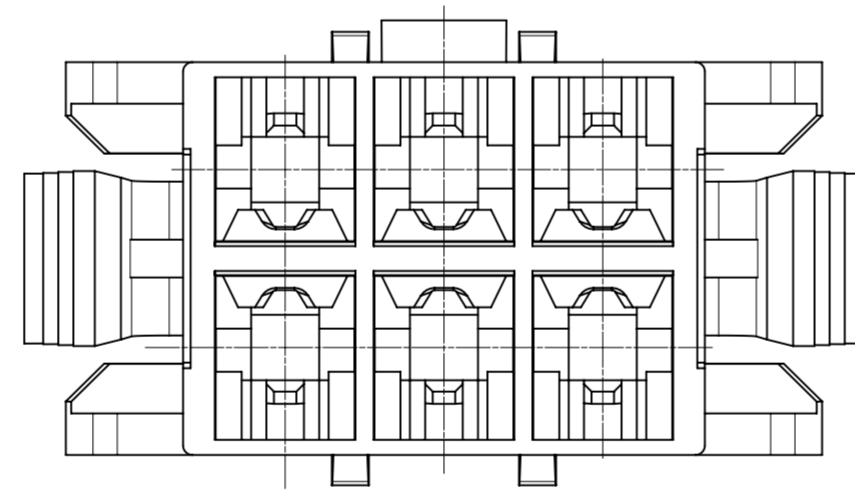
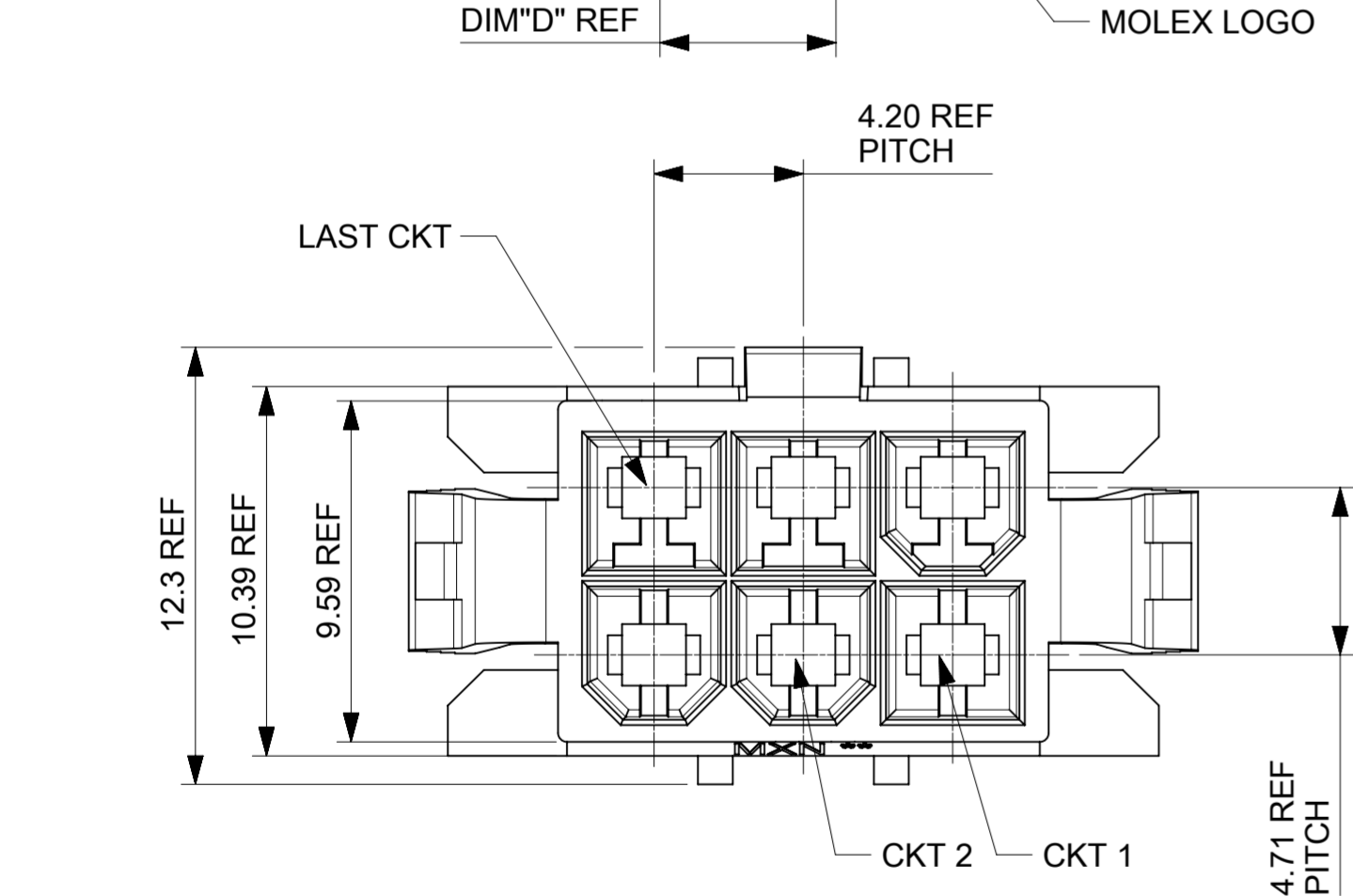
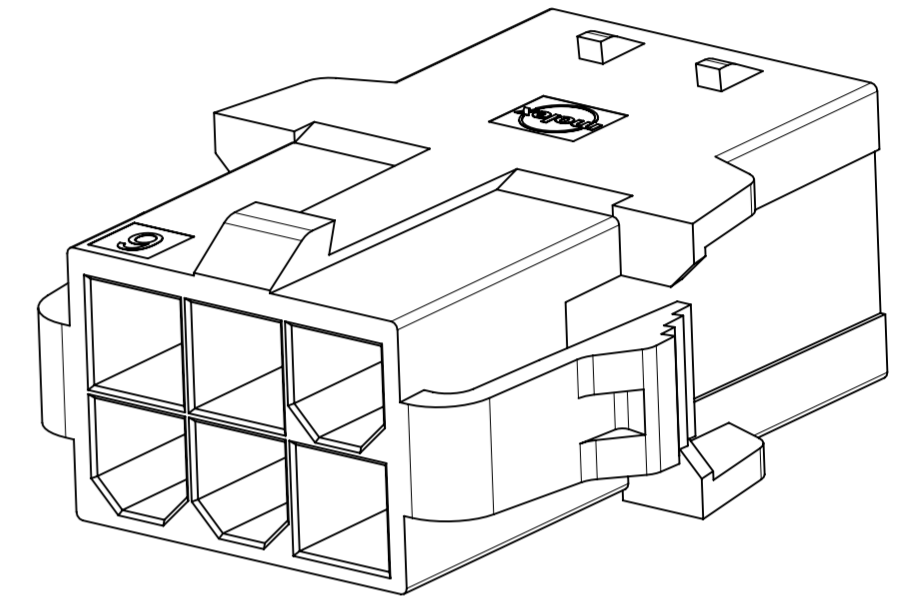

- NOTES:
- MATERIAL: NYLON, UL 94V-0 AND GLOW WIRE CAPABLE PER IEC60335-1; COLOR: BLACK
 - FINISH: NONE
 - PRODUCT SPECIFICATION: 2131370000-PS/2029880002-PS
APPLICATION SPECIFICATION: 2131370000-AS
 - PACKAGING SPECIFICATION: 172762-0001-PK
REFER TO AS-45499-001 FOR MOISTURIZING NYLON CONNECTOR PARTS.
 - THIS PART TO BE USED WITH FEMALE TERMINAL SERIES 172765, 203070 AND TPA SERIES 172709-2***.
 - THIS PART MATES WITH SERIES 172708-1***
 - THIS PART CONFORMS TO CLASS 'B' REQUIREMENTS OF COSMETIC SPECIFICATION PS-45499-002.
 - SEE DRAWING 1727090002-SD FOR OTHER TPA INFORMATION.
 - SEE DRAWING 1727080002-SD FOR OTHER RECEPTACLE INFORMATION.
 - SEE DRAWINGS SD-172718-0000 AND 2029880001-PSD FOR OTHER CRIMP TERMINAL INFORMATION.

RECOMMENDED PANEL CUT-OUT DIMENSIONS
PANEL THICKNESS 0.80-2.00MM

THIS DRAWING CONTAINS INFORMATION THAT IS PROPRIETARY TO MOLEX ELECTRONIC TECHNOLOGIES, LLC AND SHOULD NOT BE USED WITHOUT WRITTEN PERMISSION

DIMENSION UNITS	SCALE	CURRENT REV DESC:		molex		
mm	NTS					
GENERAL TOLERANCES (UNLESS SPECIFIED)				SD-DRAWING OF MINI-FIT SIGMA DR PLUG		
ANGULAR TOL	±	°	PRODUCT CUSTOMER DRAWING			
4 PLACES	±		EC NO: 735375	DOCUMENT NUMBER		
3 PLACES	±		DRWN: JERRYW8	2023/01/06	DOC TYPE DOC PART REVISION	
2 PLACES	±	0.25	CHK'D: XQZHANG	2023/02/01	1727670002-SD PSD 000 A6	
1 PLACE	±	0.36	APPR: XQZHANG	2023/02/01		
0 PLACES	±		INITIAL REVISION:	MATERIAL NUMBER		
DRAFT WHERE APPLICABLE MUST REMAIN WITHIN DIMENSIONS			DRWN: ALUO02	2019/09/24	CUSTOMER	
THIRD ANGLE PROJECTION			APPR: YXZHENG	2019/10/11	SHEET NUMBER	
DRAWING			SERIES	SEE TABLE	GENERAL MARKET	
A2-SIZE			172767	1 OF 4		

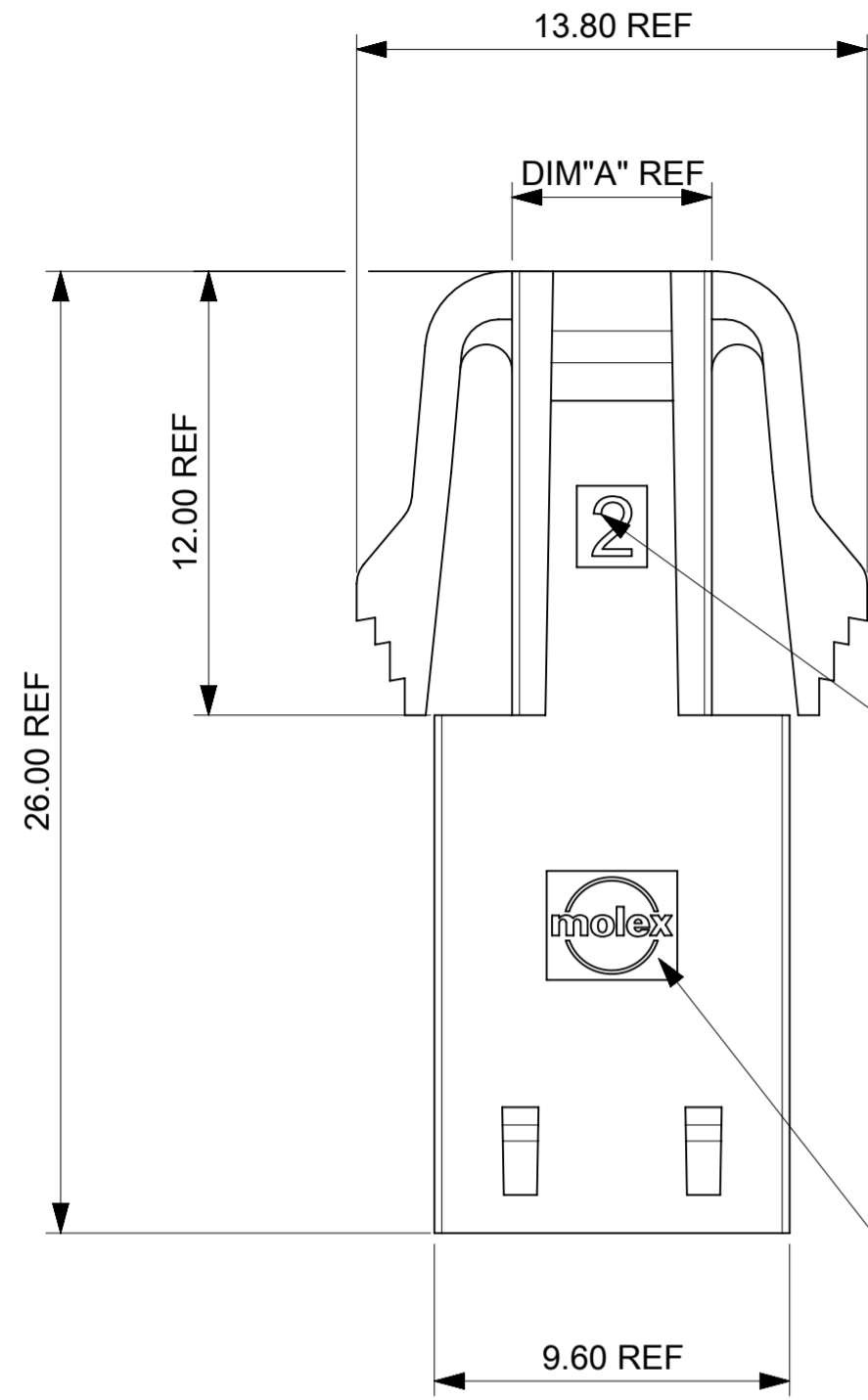

LAST CKT CODE

MOLEX LOGO

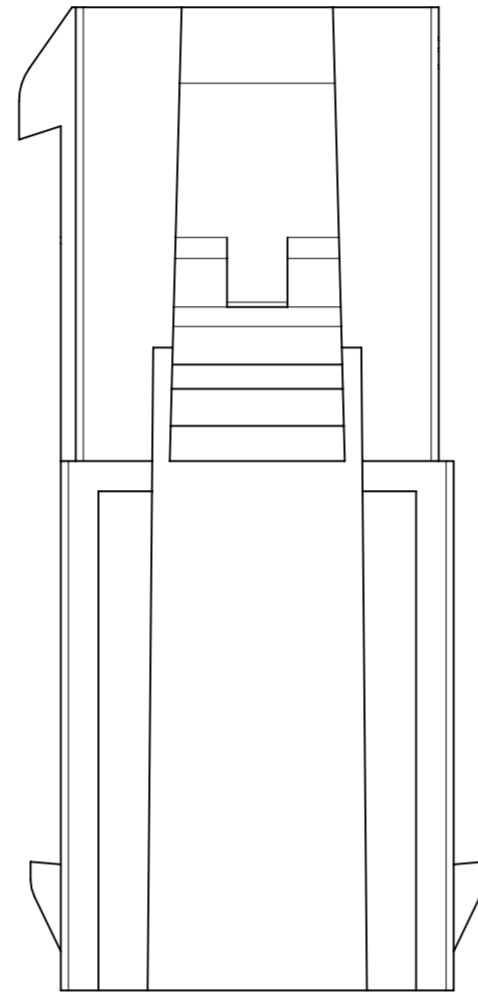

PLUG SERIES

MOLEX PLANT CODE

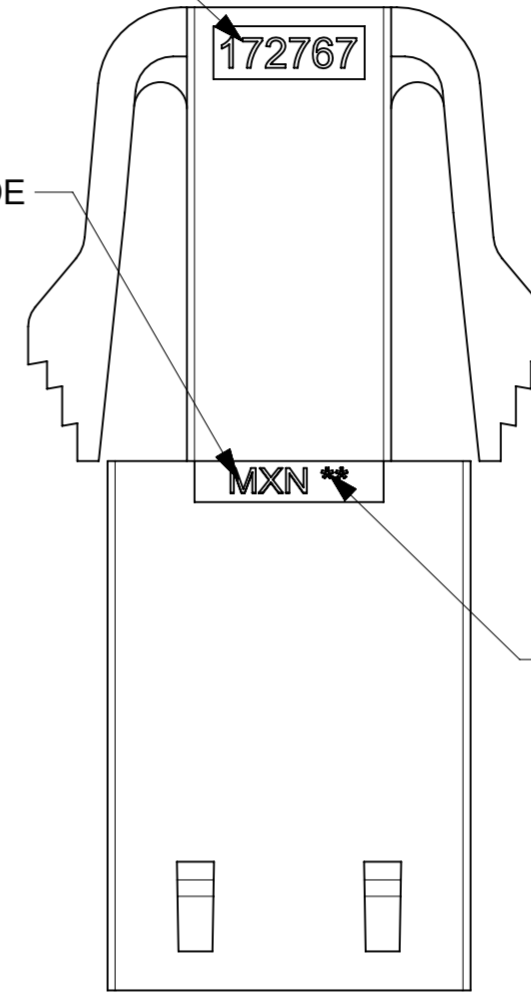

CAVITY CODE

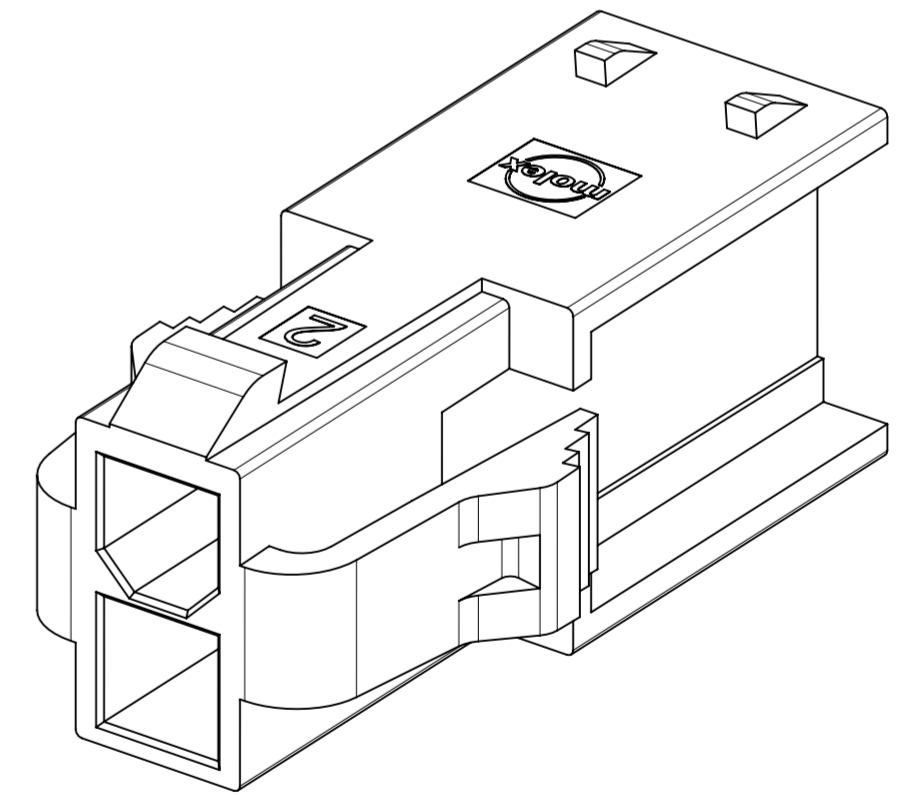
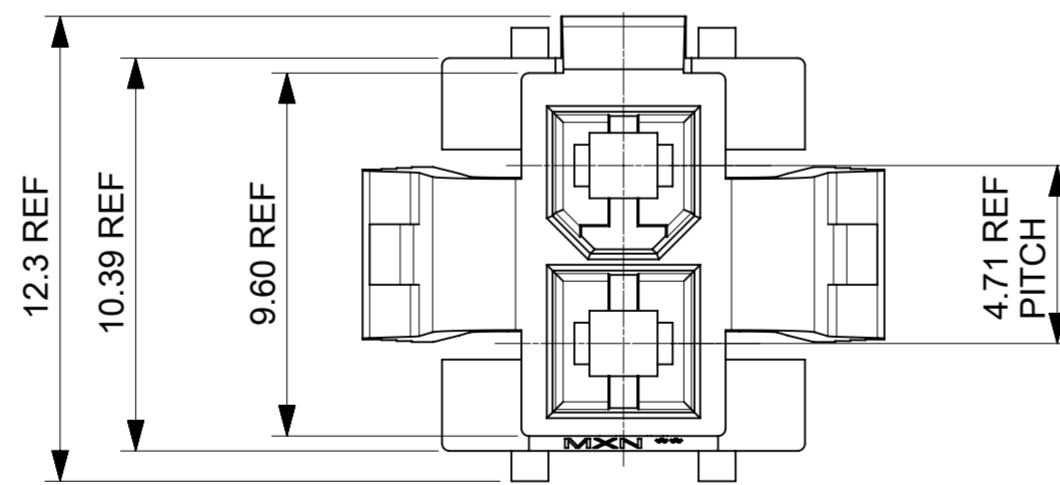
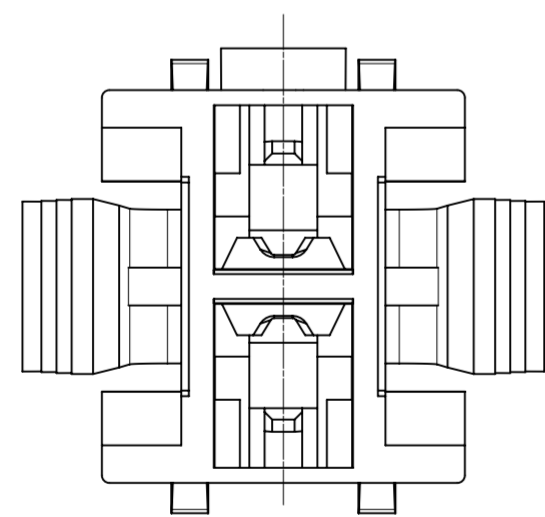

THIS DRAWING CONTAINS INFORMATION THAT IS PROPRIETARY TO MOLEX ELECTRONIC TECHNOLOGIES, LLC AND SHOULD NOT BE USED WITHOUT WRITTEN PERMISSION

DIMENSION UNITS	SCALE	CURRENT REV DESC:				molex				
mm	NTS									
GENERAL TOLERANCES (UNLESS SPECIFIED)						SD-DRAWING OF MINI-FIT SIGMA DR PLUG				
ANGULAR TOL	± °					PRODUCT CUSTOMER DRAWING				
4 PLACES	±	EC NO: 735375	2023/01/06			DOCUMENT NUMBER		DOC TYPE	DOC PART	REVISION
3 PLACES	±	DRWN: JERRYW8	2023/02/01			1727670002-SD		PSD	000	A6
2 PLACES	± 0.25	CHK'D: XQZHANG	2023/02/01			MATERIAL NUMBER		CUSTOMER		SHEET NUMBER
1 PLACE	± 0.36	APPR: XQZHANG	2023/02/01	INITIAL REVISION:		SEE TABLE		GENERAL MARKET		2 OF 4
0 PLACES	±	DRWN: ALUO02	2019/09/24	2019/10/11						
DRAFT WHERE APPLICABLE MUST REMAIN WITHIN DIMENSIONS		THIRD ANGLE PROJECTION		DRAWING	SERIES					
				A2-SIZE	172767					

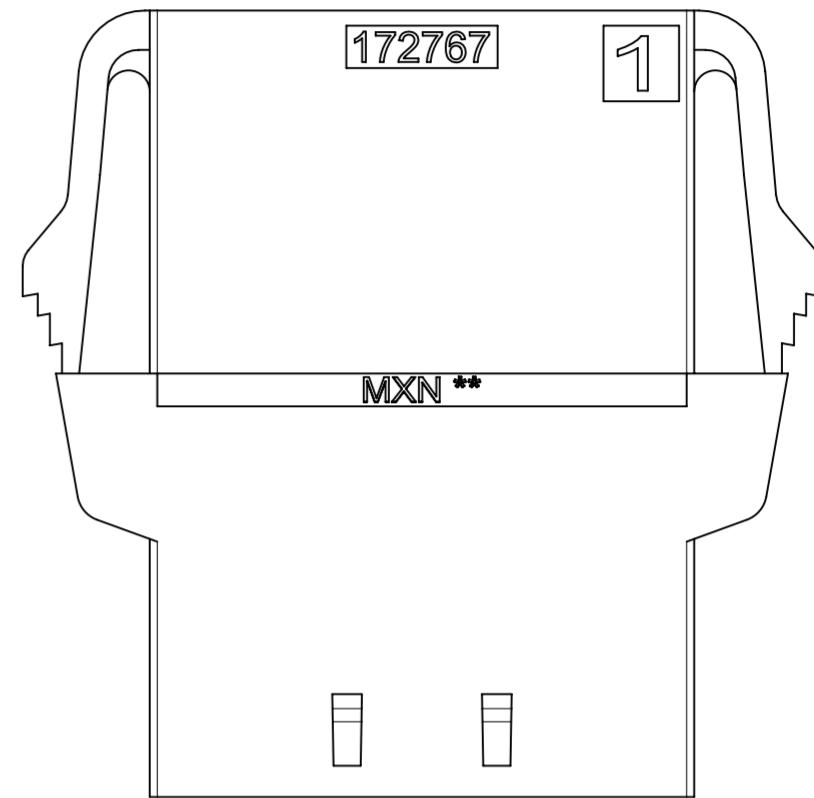
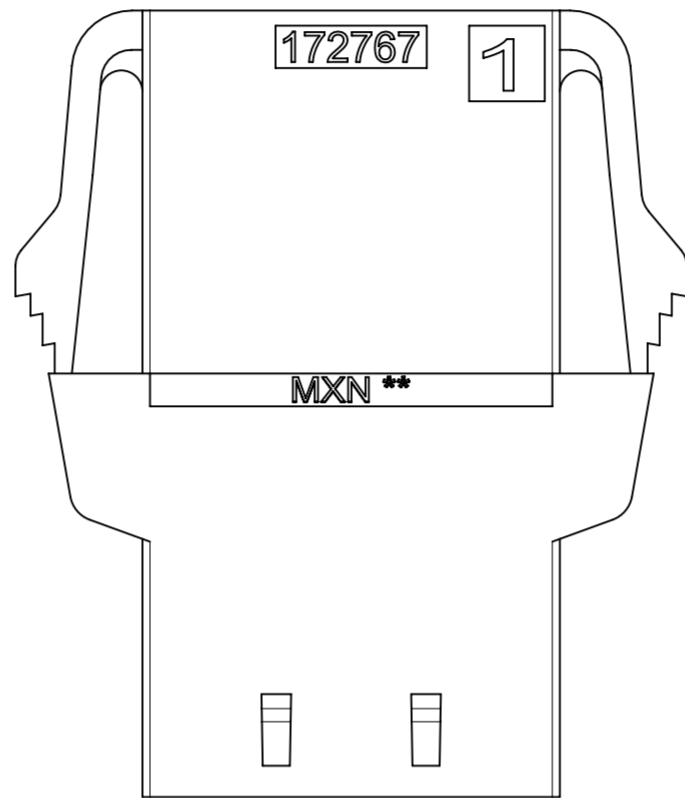
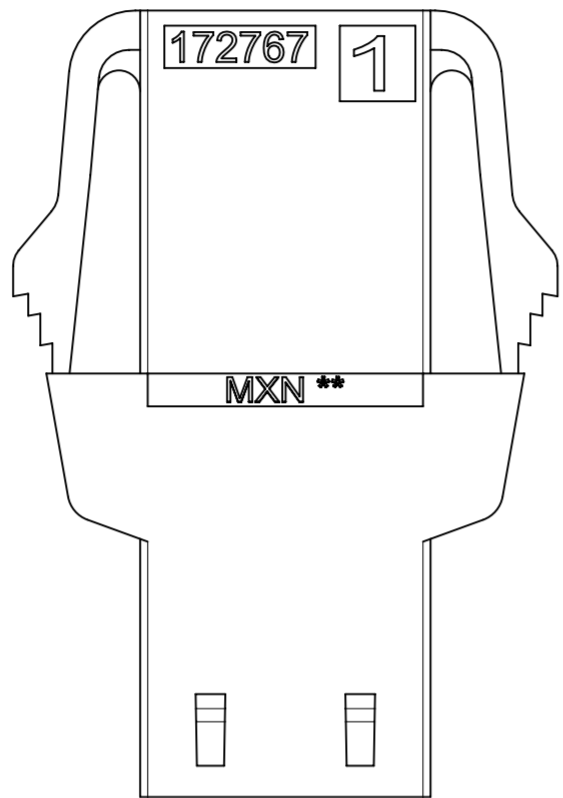
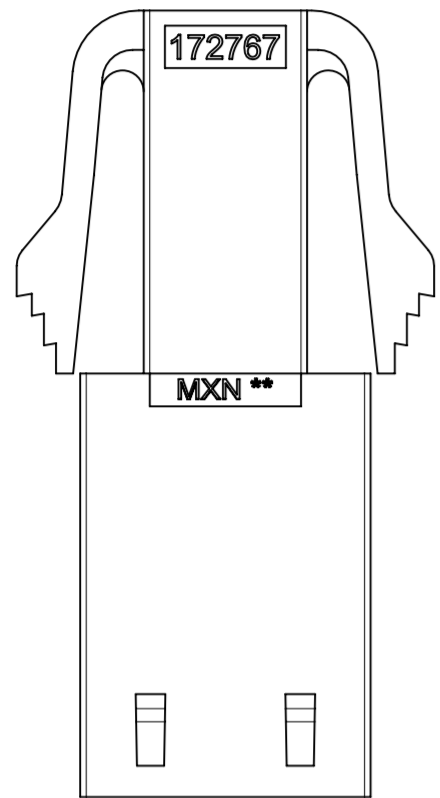
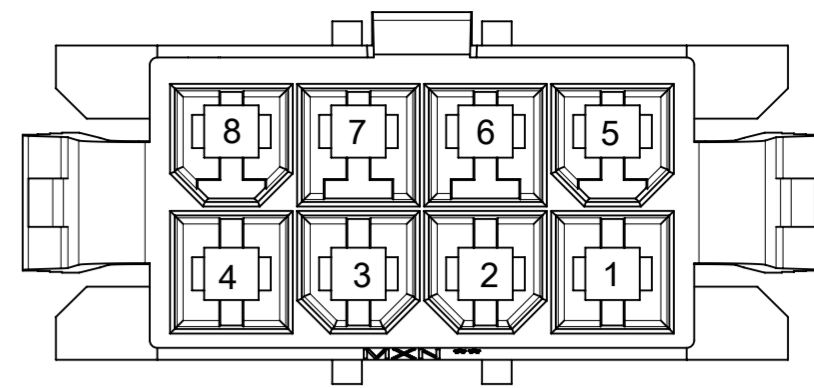
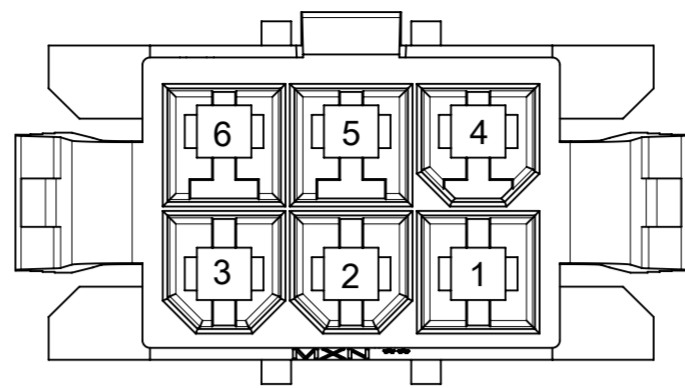
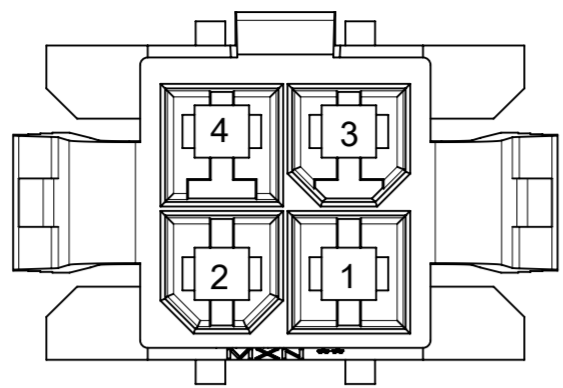
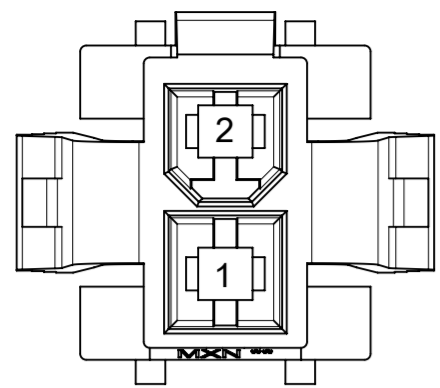

2-CKT

4-CKT

6-CKT

8-CKT

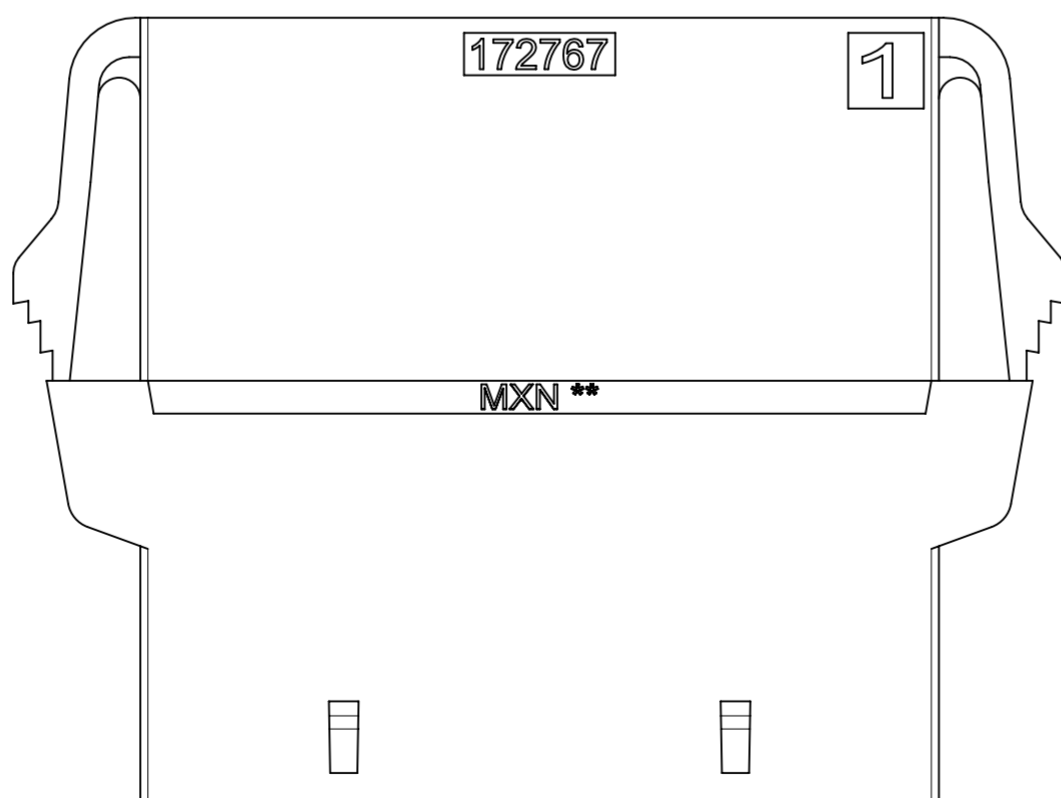
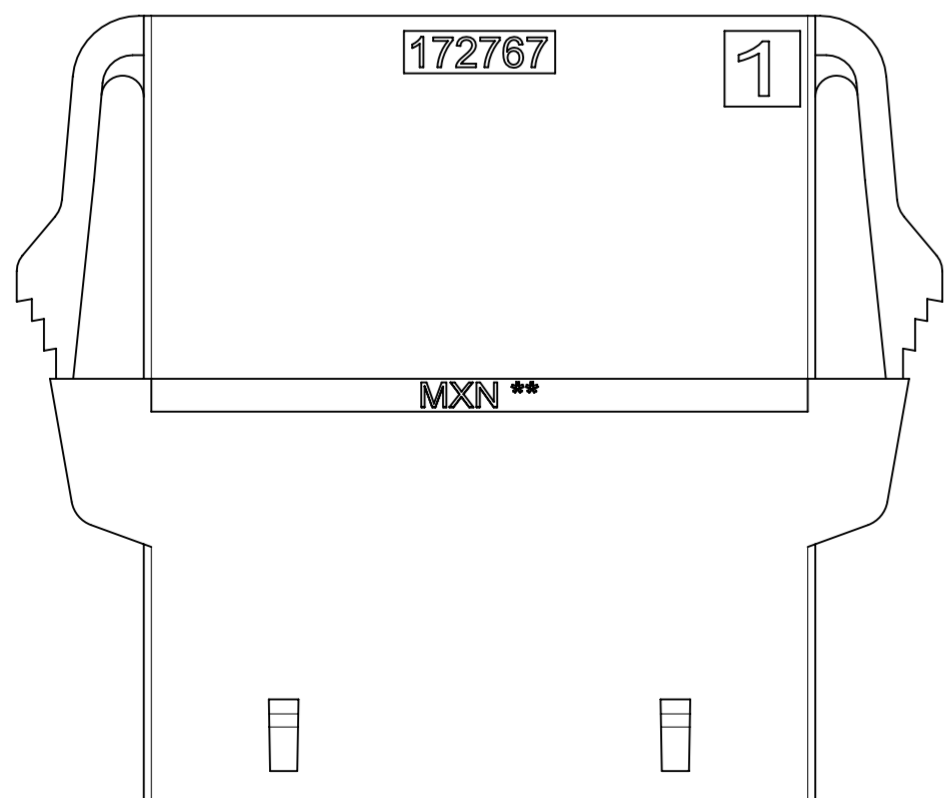
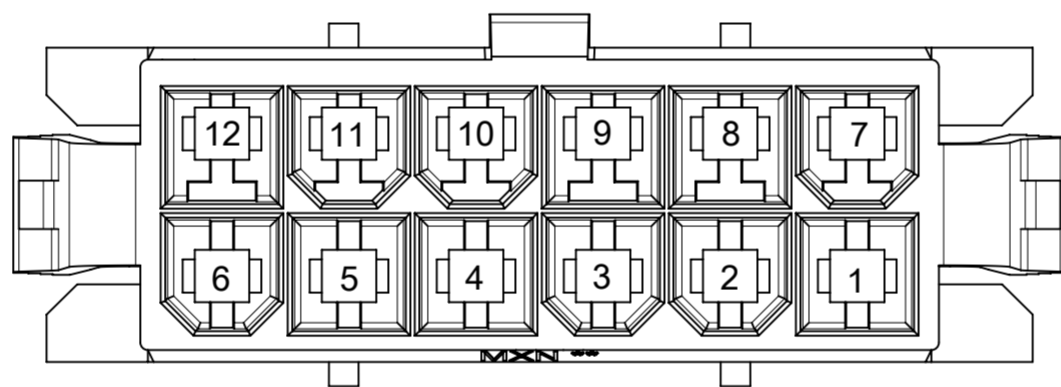
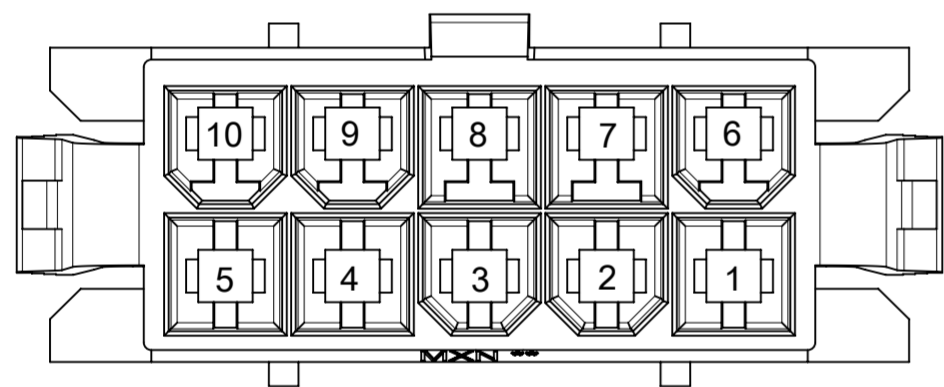

10-CKT

12-CKT

THIS DRAWING CONTAINS INFORMATION THAT IS PROPRIETARY TO MOLEX ELECTRONIC TECHNOLOGIES, LLC AND SHOULD NOT BE USED WITHOUT WRITTEN PERMISSION													
DIMENSION UNITS		SCALE		CURRENT REV DESC:						molex			
mm		NTS											
GENERAL TOLERANCES (UNLESS SPECIFIED)				EC NO: 735375 DRWN: JERRYW8 CHK'D: XQZHANG APPR: XQZHANG INITIAL REVISION: DRWN: ALUO02 APPR: YXZHENG						SD-DRAWING OF MINI-FIT SIGMA DR PLUG			
ANGULAR TOL		± °								2023/01/06		PRODUCT CUSTOMER DRAWING	
4 PLACES		±								2023/02/01		DOCUMENT NUMBER	
3 PLACES		±								2023/02/01		1727670002-SD	
2 PLACES		± 0.25								2019/09/24		DOC TYPE	
1 PLACE		± 0.36								2019/10/11		PSD	
0 PLACES		±				DOC PART							
DRAFT WHERE APPLICABLE MUST REMAIN WITHIN DIMENSIONS		THIRD ANGLE PROJECTION		DRAWING		SERIES		MATERIAL NUMBER					
				A2-SIZE		172767		SEE TABLE					
						CUSTOMER		SHEET NUMBER					
						GENERAL MARKET		3 OF 4					

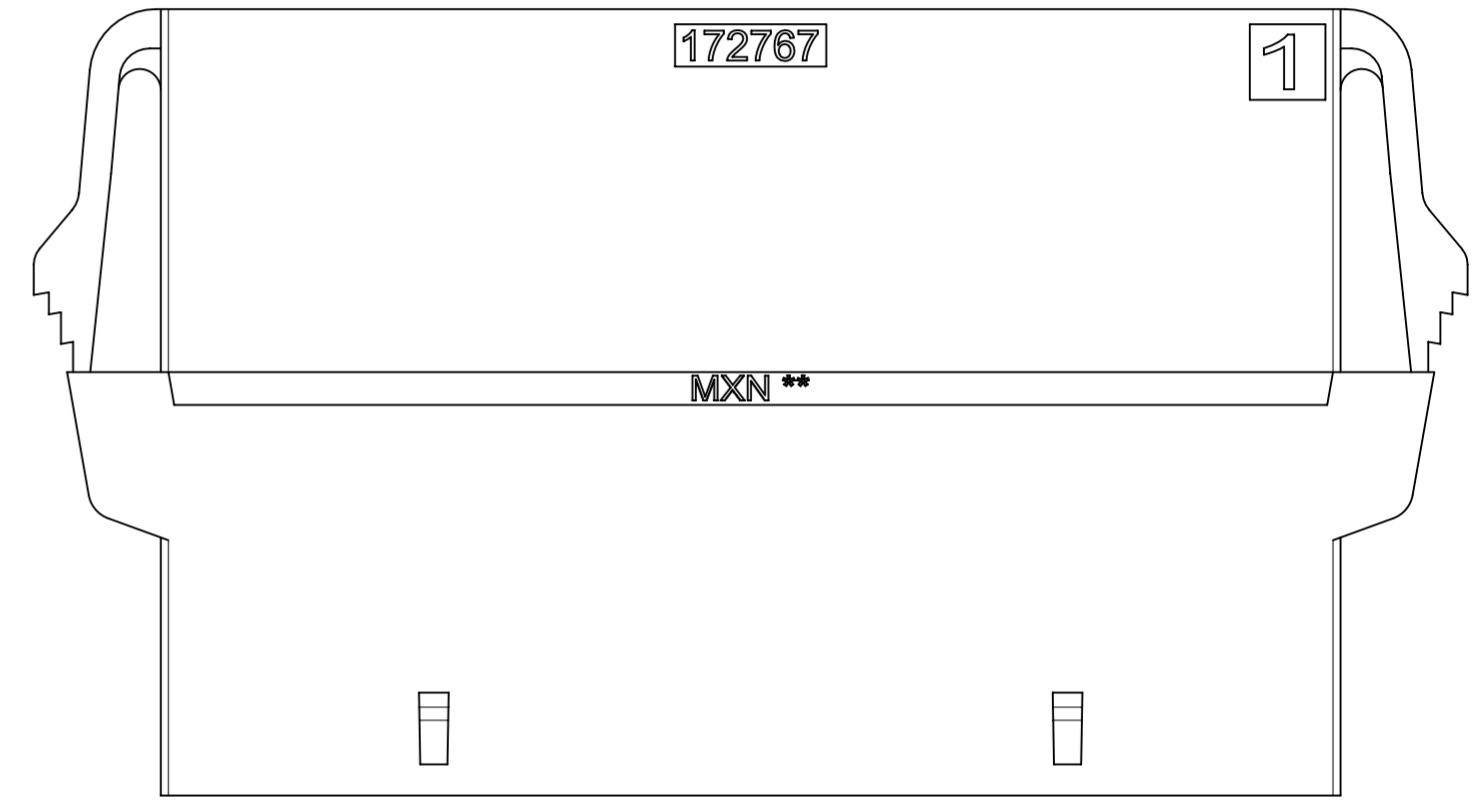
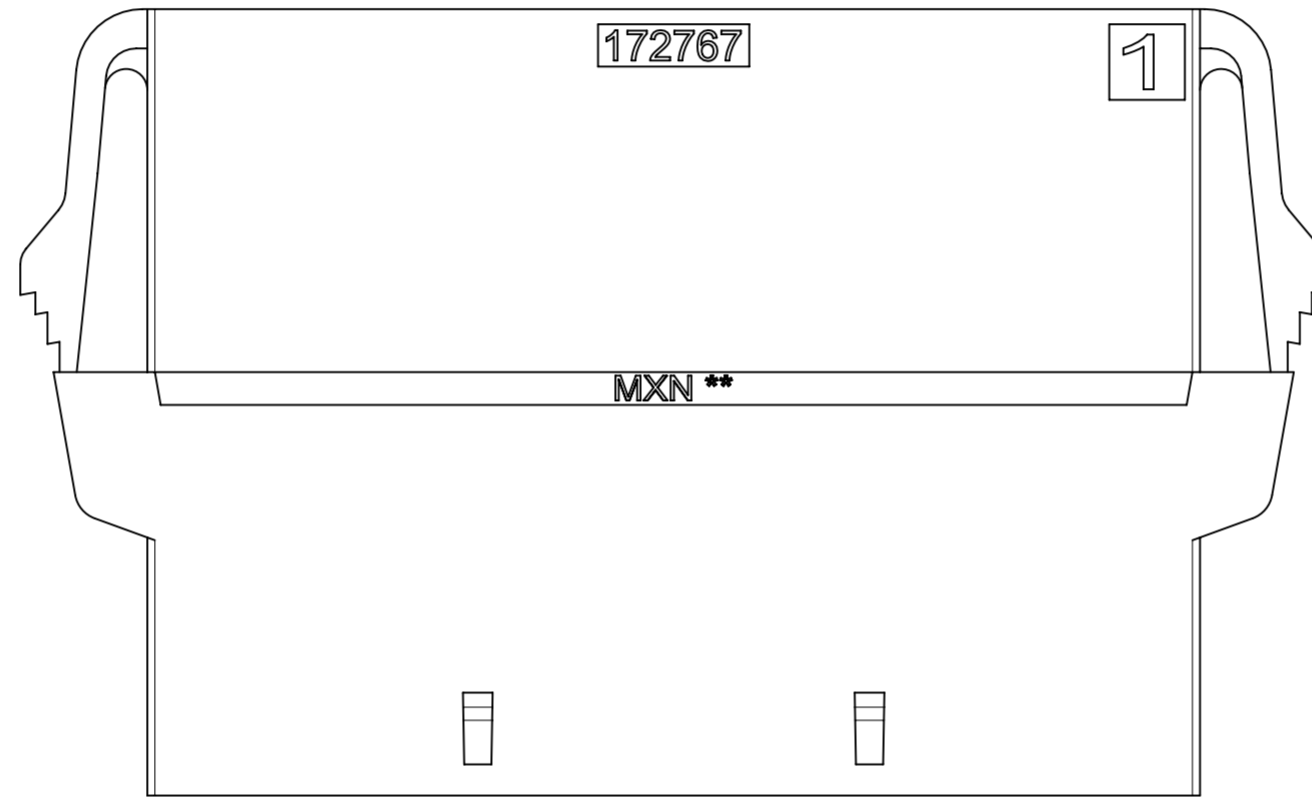
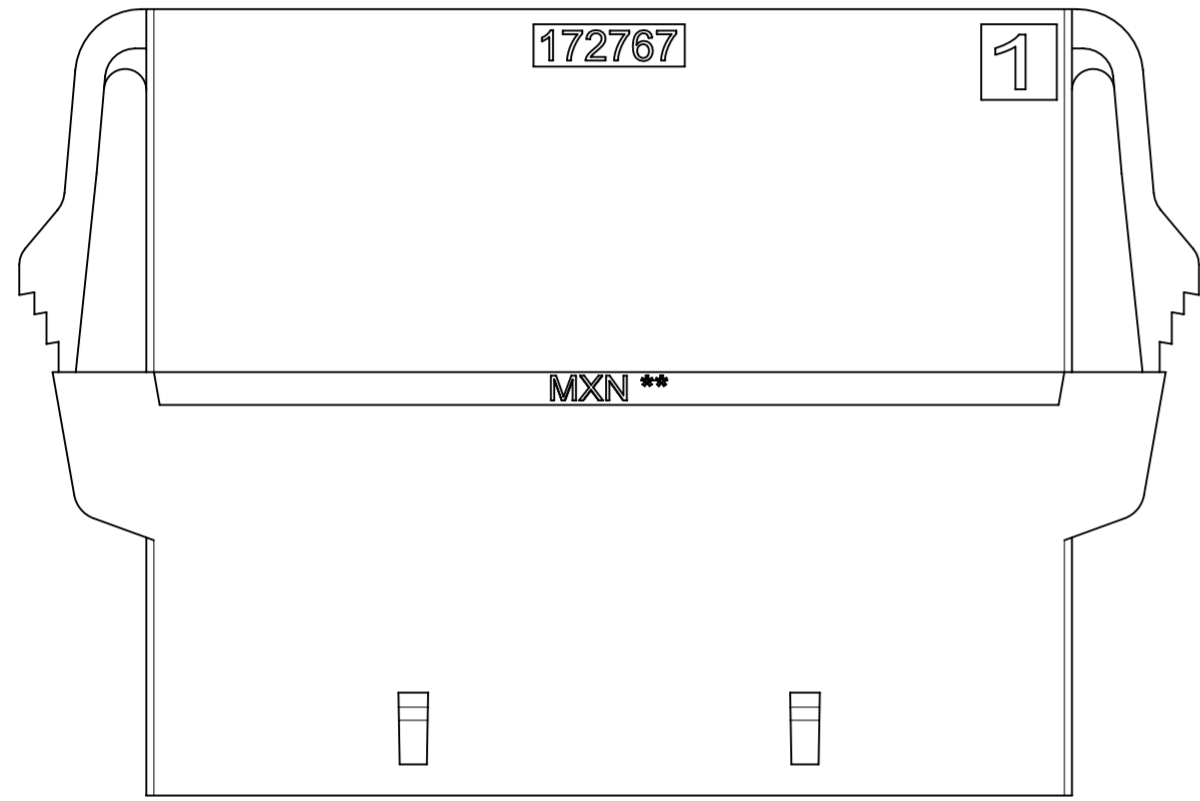
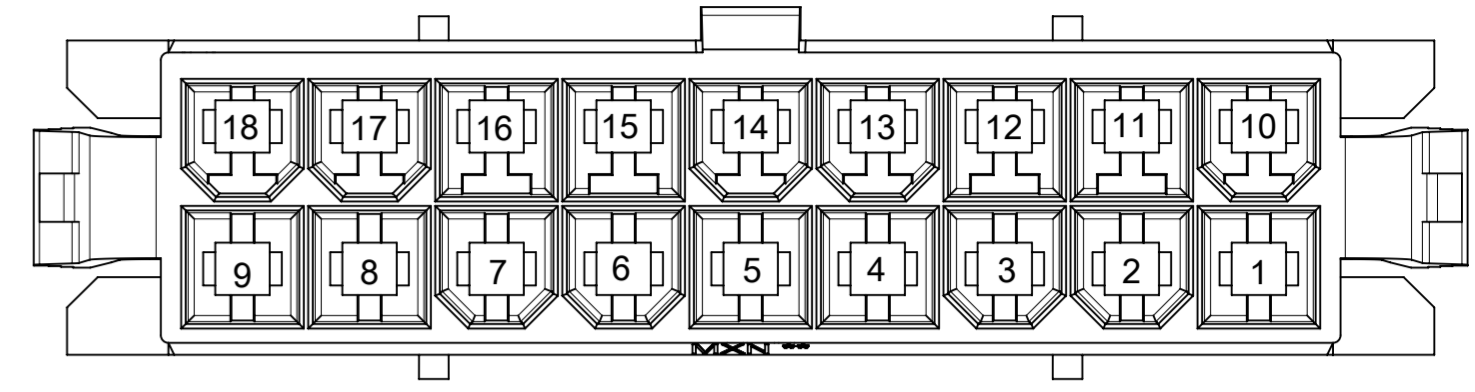
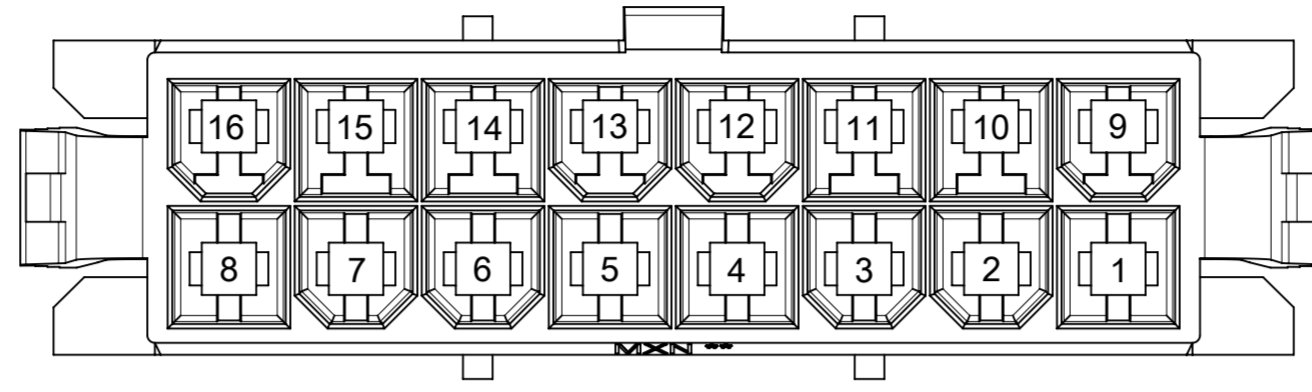
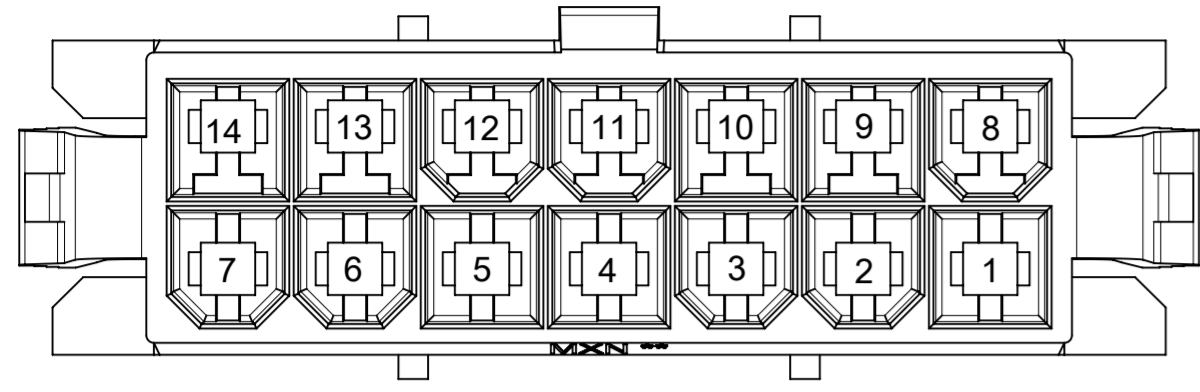

14-CKT

16-CKT

18-CKT

THIS DRAWING CONTAINS INFORMATION THAT IS PROPRIETARY TO MOLEX ELECTRONIC TECHNOLOGIES, LLC AND SHOULD NOT BE USED WITHOUT WRITTEN PERMISSION

DIMENSION UNITS	SCALE	CURRENT REV DESC:		molex			
mm	NTS						
GENERAL TOLERANCES (UNLESS SPECIFIED)				SD-DRAWING OF MINI-FIT SIGMA DR PLUG			
ANGULAR TOL	±	°		PRODUCT CUSTOMER DRAWING			
4 PLACES	±	EC NO: 735375		DOCUMENT NUMBER			
3 PLACES	±	DRWN: JERRYW8 2023/01/06		1727670002-SD			
2 PLACES	±	CHK'D: XQZHANG 2023/02/01		DOC TYPE			
1 PLACE	±	APPR: XQZHANG 2023/02/01		PSD			
0 PLACES	±	INITIAL REVISION:		DOC PART			
DRAFT WHERE APPLICABLE MUST REMAIN WITHIN DIMENSIONS		THIRD ANGLE PROJECTION		DRAWING		SERIES	
				A2-SIZE		172767	
				MATERIAL NUMBER		CUSTOMER	
				SEE TABLE		GENERAL MARKET	
				SHEET NUMBER		4 OF 4	

molex

SD-DRAWING OF MINI-FIT SIGMA DR PLUG

PRODUCT CUSTOMER DRAWING

DOCUMENT NUMBER: 1727670002-SD
DOC TYPE: PSD
DOC PART: 000
REVISION: A6