

8-1241961-2 ✓ ACTIVE

[RAST | RAST 5 IDC Connectors](#)

TE Internal #: 8-1241961-2

Housing, Receptacle, Wire-to-Board, 2 Position, .197 in [5 mm]

Centerline, Crimp, 1 Row, Natural, Mating Retention, RAST 5 IDC Connectors

[View on TE.com >](#)



[Connectors](#) > [PCB Connectors](#) > [Wire-to-Board Connectors](#) > [Wire-to-Board Connector Assemblies & Housings](#)



Connector Product Type: **Housing**

Connector & Housing Type: **Receptacle**

Connector System: **Wire-to-Board**

Number of Positions: **2**

Centerline (Pitch): **5 mm [ .197 in ]**

## Features

### Product Type Features

Connector Product Type	Housing
Connector & Housing Type	Receptacle
Connector System	Wire-to-Board
Sealable	No
Connector & Contact Terminates To	Wire & Cable

### Configuration Features

Keying & Polarized Rib Location	1a,2b
Number of Positions	2
Number of Rows	1

### Body Features

Primary Product Color	Natural
-----------------------	---------

### Termination Features

Termination Method to Wire & Cable	Crimp
------------------------------------	-------



### Mechanical Attachment

Locking Latch Between Cavity Number	1&2
Panel Mount Feature	Without
PCB Mount Retention	Without
Mating Retention Type	Latch
Mating Retention	With
Connector Mounting Type	Cable Mount (Free-Hanging)

### Housing Features

Housing Material	PA 6
Centerline (Pitch)	5 mm[.197 in]

### Dimensions

Connector Length	25.5 mm[1 in]
Connector Height	13.9 mm[.547 in]

### Usage Conditions

Operating Temperature Range	-40 – 105 °C[-40 – 221 °F]
-----------------------------	----------------------------

### Operation/Application

Circuit Application	Power & Signal
---------------------	----------------

### Industry Standards

RAST Version	02-B
Glow Wire Rating	Glow Wire
UL Flammability Rating	UL 94V-2

### Packaging Features

Packaging Quantity	3200
Packaging Method	Box & Carton

### Product Compliance

[For compliance documentation, visit the product page on TE.com>](#)

EU RoHS Directive 2011/65/EU	Compliant
EU ELV Directive 2000/53/EC	Compliant
China RoHS 2 Directive MIIT Order No 32, 2016	No Restricted Materials Above Threshold
EU REACH Regulation (EC) No. 1907/2006	Current ECHA Candidate List: JUNE 2023 (235)

Candidate List Declared Against: JUNE 2023 (235)  
Does not contain REACH SVHC

Halogen Content

Not Low Halogen - contains Br or Cl > 900 ppm.

Solder Process Capability

Not applicable for solder process capability

Product Compliance Disclaimer

This information is provided based on reasonable inquiry of our suppliers and represents our current actual knowledge based on the information they provided. This information is subject to change. The part numbers that TE has identified as EU RoHS compliant have a maximum concentration of 0.1% by weight in homogenous materials for lead, hexavalent chromium, mercury, PBB, PBDE, DBP, BBP, DEHP, DIBP, and 0.01% for cadmium, or qualify for an exemption to these limits as defined in the Annexes of Directive 2011/65/EU (RoHS2). Finished electrical and electronic equipment products will be CE marked as required by Directive 2011/65/EU. Components may not be CE marked. Additionally, the part numbers that TE has identified as EU ELV compliant have a maximum concentration of 0.1% by weight in homogenous materials for lead, hexavalent chromium, and mercury, and 0.01% for cadmium, or qualify for an exemption to these limits as defined in the Annexes of Directive 2000/53/EC (ELV). Regarding the REACH Regulation, the information TE provides on SVHC in articles for this part number is based on the latest European Chemicals Agency (ECHA) 'Guidance on requirements for substances in articles' posted at this URL: <https://echa.europa.eu/guidance-documents/guidance-on-reach>

## Compatible Parts



TE Part # 6-1241961-2  
STD TIM HOUSING MKII 2POS



TE Part # 9-1241961-2  
STD TIM HOUSING MKII 2POS



TE Part # 6-1241961-3  
STD TIM HOUSING MKII 2POS

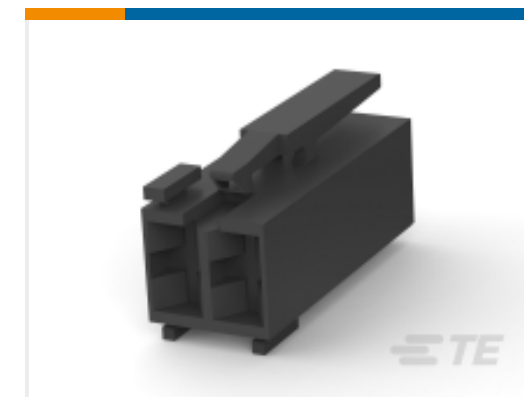

TE Part # 8-1241983-2  
STANDARD TIMER HOUSING MARK II

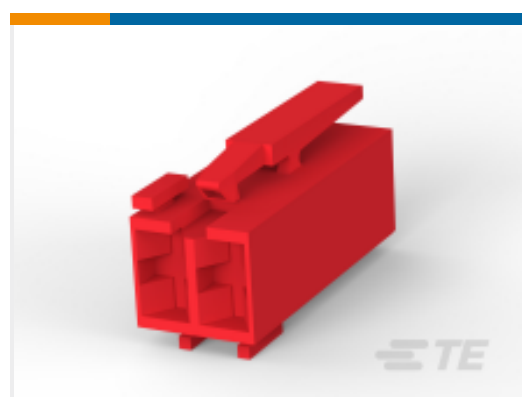

TE Part # 6-1241983-2  
STANDARD TIMER HOUSING MARK II



TE Part # 1241961-3  
STD TIM HOUSING MKII 2POS



TE Part # 1241961-1  
STD TIM HOUSING MKII 2POS



TE Part # 4-1241961-3  
2POS.STD.TIMER HSG.MARK II



TE Part # 7-1241961-2  
STD TIM HOUSING MKII 2POS



TE Part # 964768-3  
STD-TIM HSG SPECIAL 2P (NATURE)



TE Part # 3-1241961-2  
STD TIM HOUSING MKII 2POS



TE Part # 2-2178029-2  
2P ST-TIMER HSG BLACK, V0



## Also in the Series | RAST 5 IDC Connectors

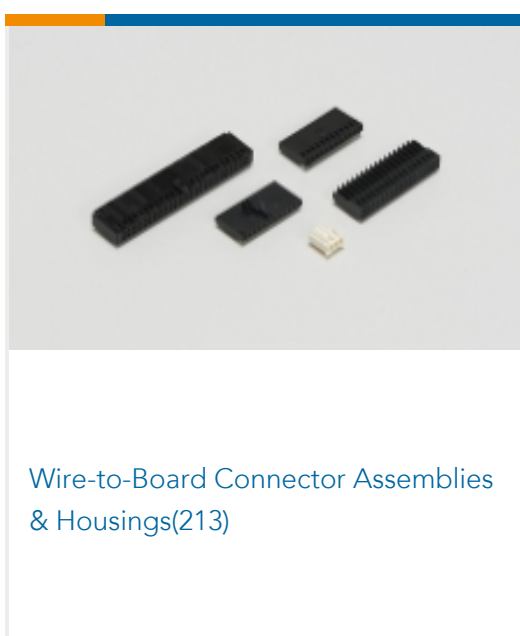
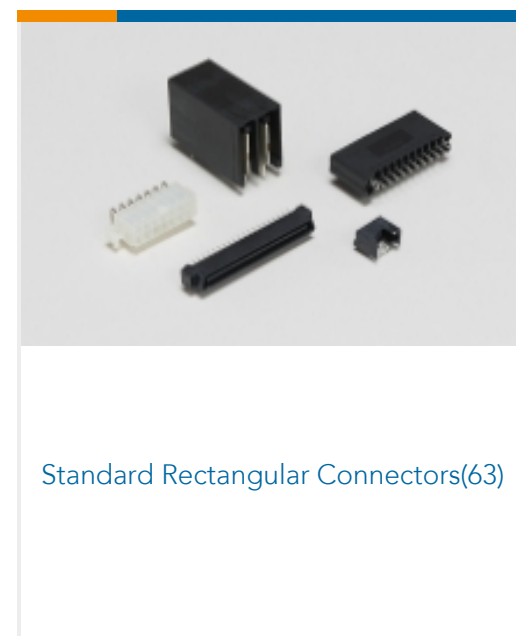
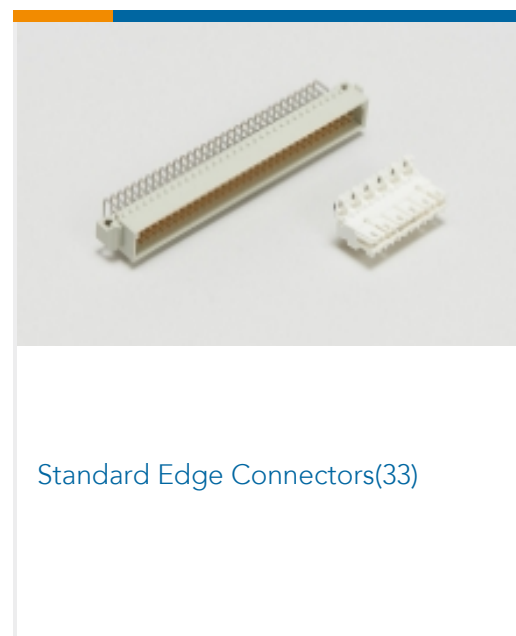
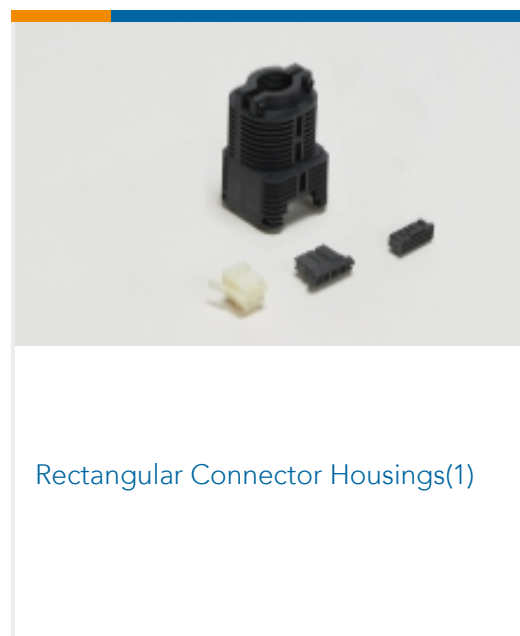
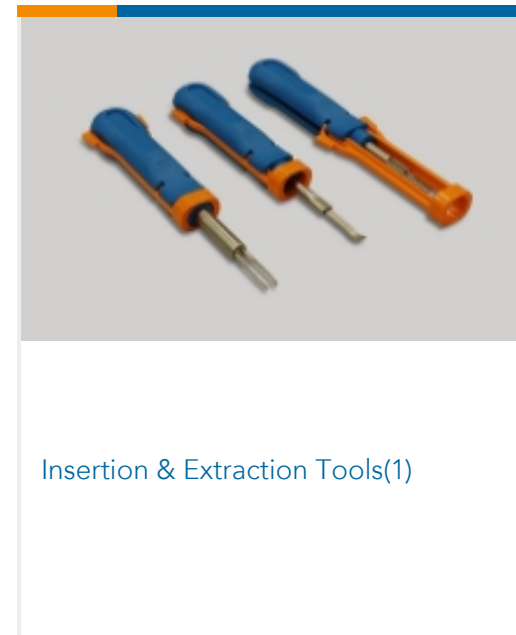
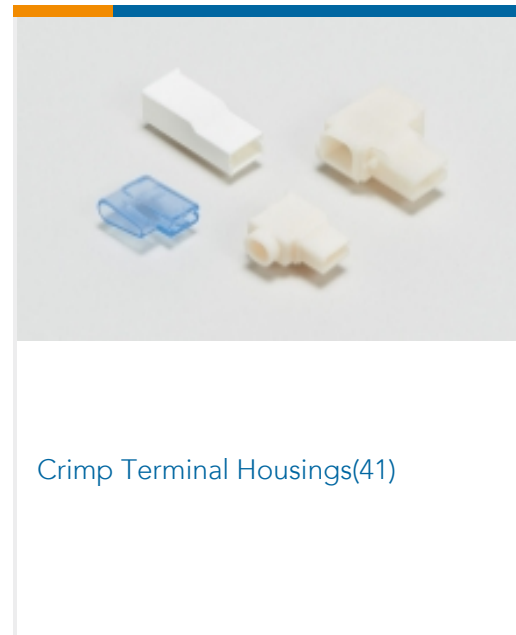
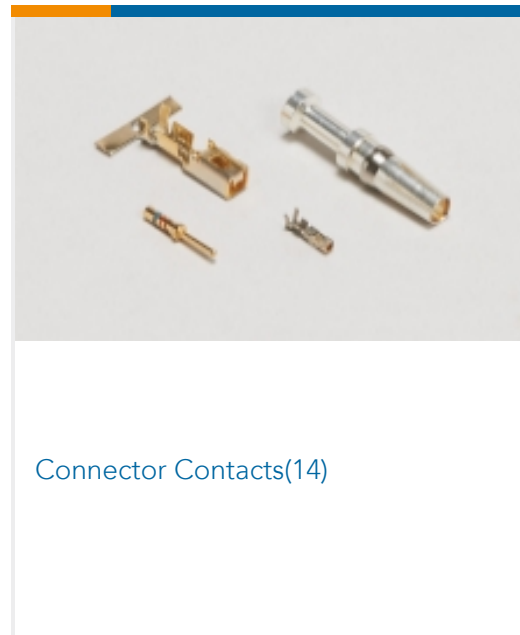
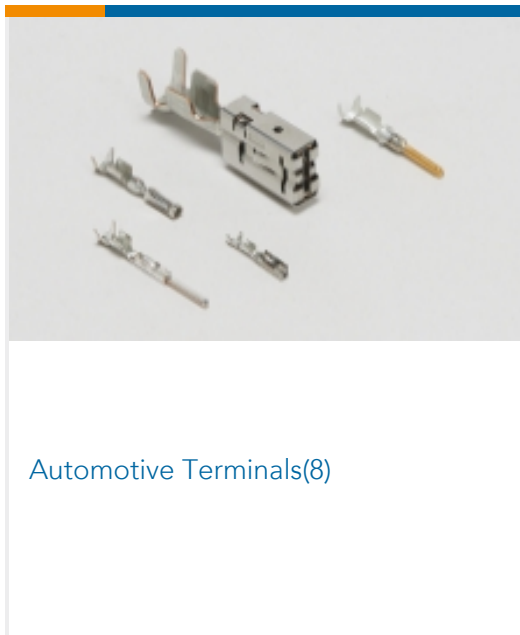

## Customers Also Bought

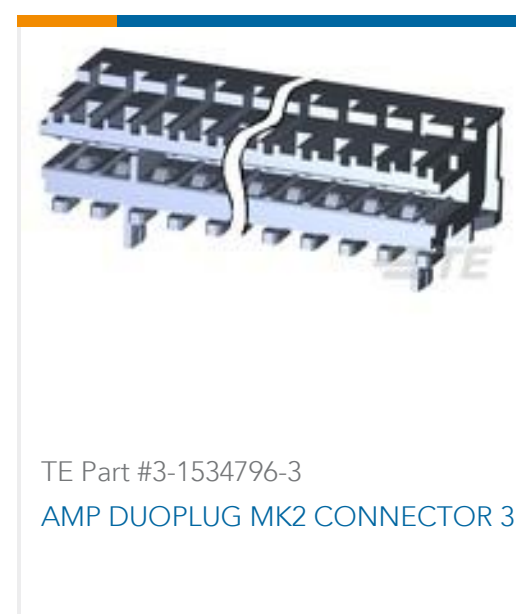
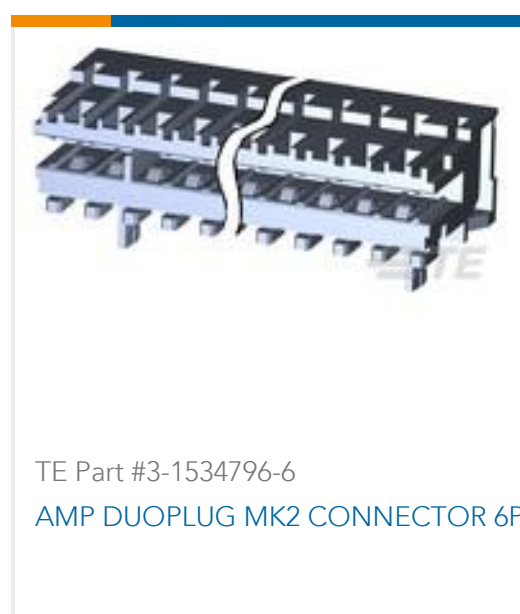



## Documents

### Product Drawings

#### STD TIM HOUSING MKII 2POS

English

### CAD Files

#### 3D PDF

3D

#### Customer View Model

[ENG\\_CVM\\_CVM\\_8-1241961-2\\_C.2d\\_dxf.zip](#)

English

#### Customer View Model

[ENG\\_CVM\\_CVM\\_8-1241961-2\\_C.3d\\_igs.zip](#)

English

#### Customer View Model

[ENG\\_CVM\\_CVM\\_8-1241961-2\\_C.3d\\_stp.zip](#)

English

By downloading the CAD file I accept and agree to the [Terms and Conditions](#) of use.

### Product Specifications

#### Product Specification

German