

REVISIONS

P	LTR	DESCRIPTION	DATE	DWN	APVD
	A	INITIAL RELEASE	19JUN2020	J.G	I.Y
	A1	ECR-20-010349	26JUL2020	J.G	I.Y
	A2	ECN-21-113425	17AUG2021	J.G	Z.Z

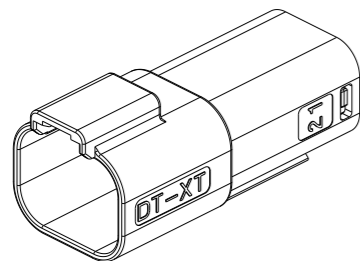

4CCT RECEPTACLE CONNECTOR WITHOUT HEATSHRINK HOUSING

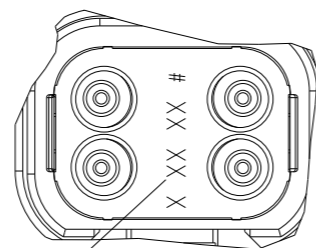

DETAIL A SCALE 2:1

4 DATE CODE: X XX XX
 X- DAY: 1- 7
 XX- WEEK: 01 - 52
 XX- YEAR: 00 - 99

#- MACHINE NO. 1

EXAMPLE: 11315 = DAY 1, WEEK 13, YEAR 15
i.e. 23rd OF MARCH 2015

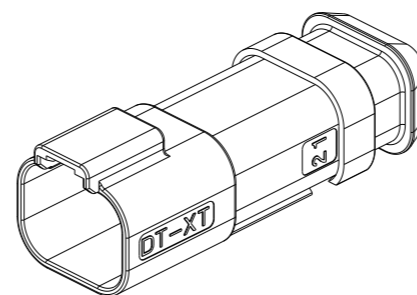

4CCT RECEPTACLE CONNECTOR WITH HEATSHRINK HOUSING ULTRASONICALLY WELDED IN PLACE

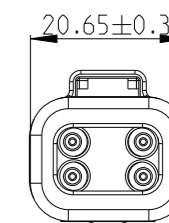
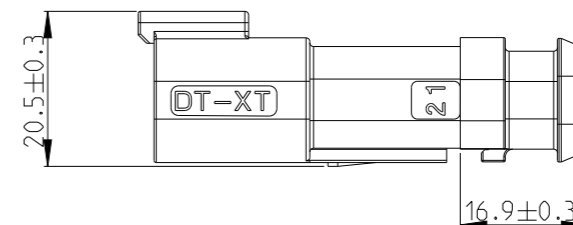
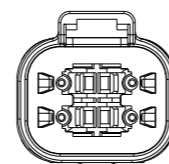
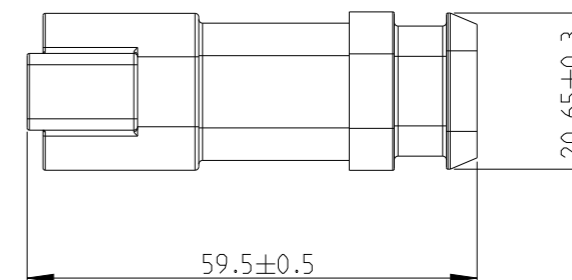
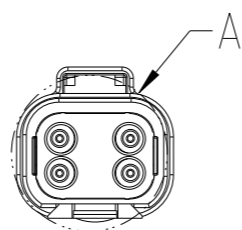
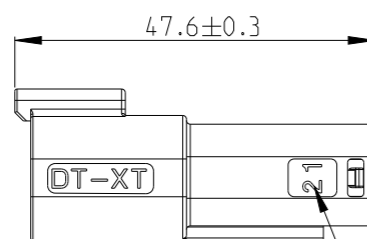
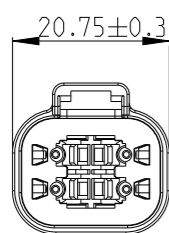

1. THIS RECEP MATES WITH PLUG ASSEMBLY PN X-2600031-X, WEDGE LOCK PN W4PX.

2. MATERIALS

- RECEPTACLE HOUSING: NYLON GF30, SEE PN TABLE FOR COLOUR
- BACK SEAL: SILICONE RUBBER
- BACK COVER: NYLON GF30, BLACK
- HEATSHRINK HOUSING: NYLON GF30, BLACK

3 CIRCUIT IDENTIFICATION

4 DATE CODE DESCRIPTION

5. JACKET RANGE LARGE = Ø2.23MM TO 3.68MM (SEAL COLOUR: LIGHT BLUE)
JACKET RANGE SMALL = Ø1.20MM TO 3.05MM (SEAL COLOUR: BURNT ORANGE)

6. SEE SHEET 2 FOR FINAL PART NUMBER

THIS DRAWING IS A CONTROLLED DOCUMENT.

DIMENSIONS:	TOLERANCES UNLESS OTHERWISE SPECIFIED:
mm	
	0 PLC ±
	1 PLC ±
	2 PLC ±
	3 PLC ±
	4 PLC ±
	ANGLES ±
MATERIAL -	FINISH -

DWN	J.GU	19JUN2020
CHK	E. JIANG	19JUN2020
APVD	I.YIN	19JUN2020
PRODUCT SPEC	108-160026	
APPLICATION SPEC	114-160017	
WEIGHT	-	

TE Connectivity		NAME		RESTRICTED TO
		4CCT DT-XT CONNECTOR RECEPTACLE ASSEMBLY		
SIZE	CAGE CODE	DRAWING NO		
A3	00779	C-2600030		
CUSTOMER DRAWING;RESTRICTED CUSTOMER		SCALE	SHEET	REV
		1:1	1 OF 2	A2

THIS DRAWING IS UNPUBLISHED.

RELEASED FOR PUBLICATION

20

REVISIONS

© COPYRIGHT 2020 TE Connectivity. All Rights Reserved.

ALL RIGHTS RESERVED.

P	LTR	DESCRIPTION	DATE	DWN	APVD
		SEE SHEET 1			

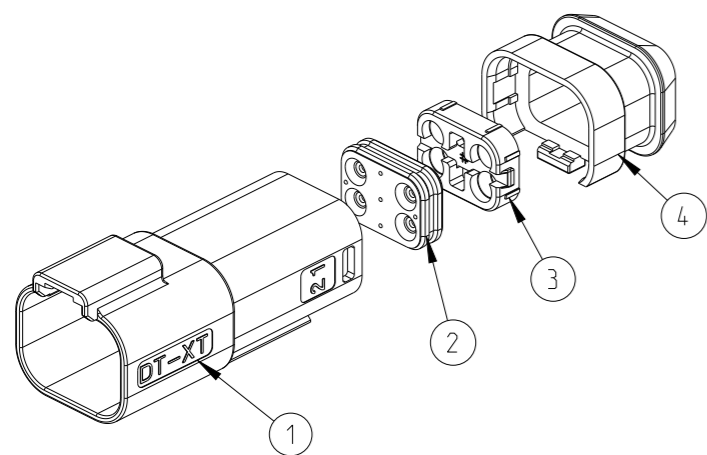

3--6	934443609	-	10.02
3--5	934443608	-	10.02
3--4	934443607	-	10.02
3--3	934443606	-	10.02
3--2	934443605	-	10.02
3--1	934443604	-	10.02
3--0	934443603	-	10.02
2--9	934443602	-	10.02
2--8	934443601	-	10.02
2--7	934443509	-	10.02
2--6	934443508	-	10.02
2--5	934443507	-	10.02
2--4	934443506	-	10.02
2--3	934443505	-	10.02
2--2	934443504	-	10.02
2--1	934443503	-	10.02
2--0	934443502	-	10.02
1--9	934443501	-	10.02
1--8	934443209	-	7.61
1--7	934443208	-	7.61
1--6	934443207	-	7.61
1--5	934443206	-	7.61
1--4	934443205	-	7.61
1--3	934443204	-	7.61
1--2	934443203	-	7.61
1--1	934443202	-	7.61
1--0	934443201	-	7.61
-9	934443109	-	7.61
-8	934443108	-	7.61
-7	934443107	-	7.61
-6	934443106	-	7.61
-5	934443105	-	7.61
-4	934443104	-	7.61
-3	934443103	-	7.61
-2	934443102	-	7.61
-1	934443101	-	7.61

QTY. REQUEST PER ASSY

TE PN	ALIAS PN	REVISION OF EACH ASSY NO.	WEIGHT OF EACH ASSY(g)	COLOR	BLACK	GERY	GREEN	BLUE	YELLOW	WHITE	BROWN	ORANGE	RED	BURNT ORANGE	LIGHT BLUE	BLACK	BLACK	
				MATERIAL	NYLON GF30	NYLON GF30	NYLON GF30	NYLON GF30	NYLON GF30	NYLON GF30	NYLON GF30	NYLON GF30	NYLON GF30	SILICONE RUBBER	SILICONE RUBBER	NYLON GF30	NYLON GF30	
				DESCRIPTION	RECEPTACLE HOUSING										BACK SEAL SMALL	BACK SEAL LARGE	BACK COVER	HEATSHRINK HOUSING
				ITEM NO	1										2		3	4

THIS DRAWING IS A CONTROLLED DOCUMENT.

DIMENSIONS: mm

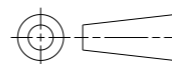

TOLERANCES UNLESS OTHERWISE SPECIFIED:

- 0 PLC ±
- 1 PLC ±
- 2 PLC ±
- 3 PLC ±
- 4 PLC ±
- ANGLES ±
- FINISH -

MATERIAL

DWN J.GU 19JUN2020
 CHK E. JIANG 19JUN2020
 APVD L.YIN 19JUN2020
 PRODUCT SPEC 108-160026
 APPLICATION SPEC 114-160017
 WEIGHT -



TE Connectivity

NAME 4CCT DT-XT CONNECTOR RECEPTACLE ASSEMBLY

SIZE A3 CAGE CODE 00779 DRAWING NO. C-2600030 RESTRICTED TO -

CUSTOMER DRAWING;RESTRICTED CUSTOMER SCALE 1:1 SHEET 2 OF 2 REV A2