



Economy Power

TE Internal #: 2-1744036-6

Rectangular Connector Housings, Wire-to-Board, 6 Position, .2 in [5.08 mm] Centerline, 1 Row, Nylon, Plug, Socket, Economy Power

[View on TE.com >](#)

Connectors > Rectangular Connectors > Rectangular Connector Housings



Connector System: **Wire-to-Board**

Number of Positions: **6**

Centerline (Pitch): **5.08 mm [.2 in]**

Number of Rows: **1**

Housing Material: **Nylon**

Features

Product Type Features

Connector System	Wire-to-Board
Connector & Housing Type	Plug
Sealable	No
Connector & Contact Terminates To	Printed Circuit Board

Configuration Features

Insertion Force	6.9 Newton
Number of Cavities	6
Number of Positions	6
Number of Rows	1

Electrical Characteristics

Operating Voltage	250 VAC
-------------------	---------

Contact Features

Contact Layout	Inline
Contact Type	Socket



Mechanical Attachment

Connector Mounting Type	Cable Mount (Free-Hanging)
-------------------------	----------------------------

Housing Features

Housing Color	Natural
Centerline (Pitch)	5.08 mm[.2 in]
Housing Material	Nylon

Dimensions

Connector Height	13.3 mm[.524 in]
Product Width	10.5 mm[.413 in]
Product Length	29.3 mm[1.154 in]

Usage Conditions

Operating Temperature Range	-25 – 105 °C[-13 – 221 °F]
-----------------------------	----------------------------

Operation/Application

Halogen Free	Yes
Circuit Application	Power

Identification Marking

Circuit Identification Feature	With
--------------------------------	------

Industry Standards

Glow Wire Rating	Standard Part - Not Glow Wire
UL Flammability Rating	UL 94V-0

Packaging Features

Packaging Quantity	500
Packaging Method	Bag

Product Compliance

[For compliance documentation, visit the product page on TE.com>](#)

EU RoHS Directive 2011/65/EU	Compliant
EU ELV Directive 2000/53/EC	Compliant
China RoHS 2 Directive MIIT Order No 32, 2016	No Restricted Materials Above Threshold
EU REACH Regulation (EC) No. 1907/2006	Current ECHA Candidate List: JUNE 2023 (235) Candidate List Declared Against: JUNE 2023 (235)



Does not contain REACH SVHC

Halogen Content

Low Halogen - Br, Cl, F, I < 900 ppm per homogenous material. Also BFR/CFR/PVC Free

Solder Process Capability

Not reviewed for solder process capability

Product Compliance Disclaimer

This information is provided based on reasonable inquiry of our suppliers and represents our current actual knowledge based on the information they provided. This information is subject to change. The part numbers that TE has identified as EU RoHS compliant have a maximum concentration of 0.1% by weight in homogenous materials for lead, hexavalent chromium, mercury, PBB, PBDE, DBP, BBP, DEHP, DIBP, and 0.01% for cadmium, or qualify for an exemption to these limits as defined in the Annexes of Directive 2011/65/EU (RoHS2). Finished electrical and electronic equipment products will be CE marked as required by Directive 2011/65/EU. Components may not be CE marked. Additionally, the part numbers that TE has identified as EU ELV compliant have a maximum concentration of 0.1% by weight in homogenous materials for lead, hexavalent chromium, and mercury, and 0.01% for cadmium, or qualify for an exemption to these limits as defined in the Annexes of Directive 2000/53/EC (ELV). Regarding the REACH Regulation, the information TE provides on SVHC in articles for this part number is based on the latest European Chemicals Agency (ECHA) 'Guidance on requirements for substances in articles' posted at this URL: <https://echa.europa.eu/guidance-documents/guidance-on-reach>

Compatible Parts



TE Part # 1877285-6
06P EP SHRD HDR ASMY, WHITE



TE Part # 1744036-2
02P ECONOMY POWER .200 CL HSG



TE Part # 1-1123722-6
3.96 EP PLUG HSG 6P(NATURAL)



TE Part # 1-1123723-6
3.96 EP HDR ASSY 6P(NATURAL)



TE Part # 1744057-6
3.96 EP HDR ASSY 6P W/PEGS



TE Part # 1744037-6
06P EC PWR.200 CL HDR ASSY VRT



TE Part # 1-1318300-6
3.96 EP HDR ASSY 6P NAT/TUBE



TE Part # 1-2316952-6
3.96 EP HDR ASSY 6P,NO PIN 2,4



TE Part # 3-1123722-6
3.96 EP PLUG HSG 6P(BLUE)



TE Part # 1744036-7
07P ECONOMY POWER .200 CL HSG



TE Part # 5-1123723-6
3.96 EP HDR ASSY 6P(BLACK)



TE Part # 5-1123722-6
3.96 EP PLUG HSG 6P(BLACK)

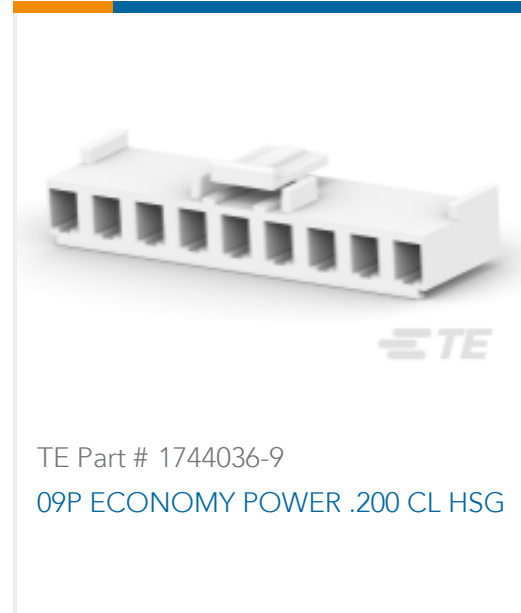

Also in the Series | Economy Power

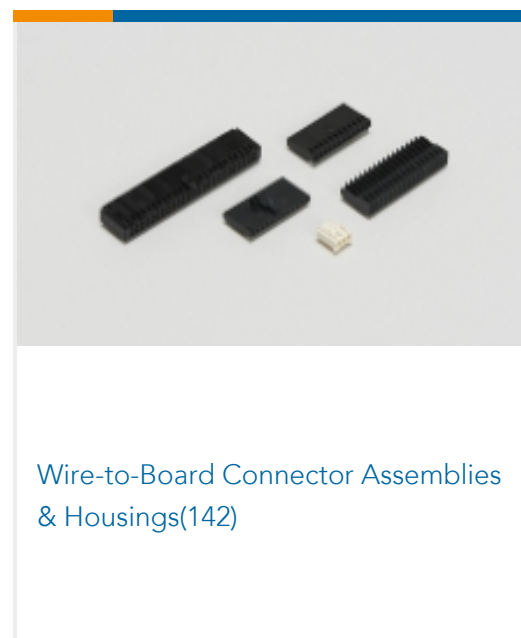
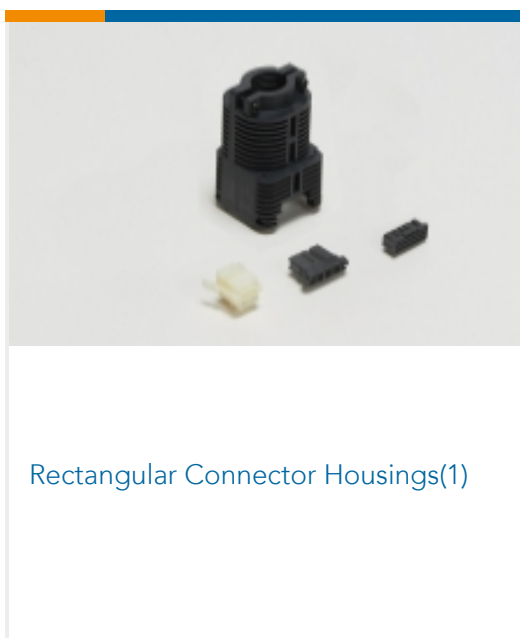
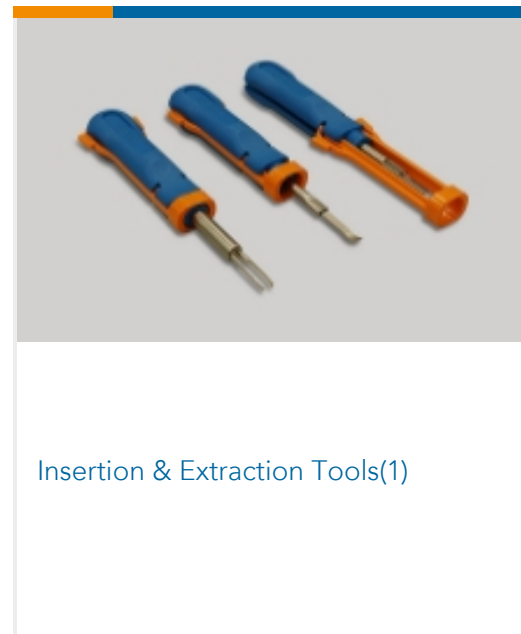
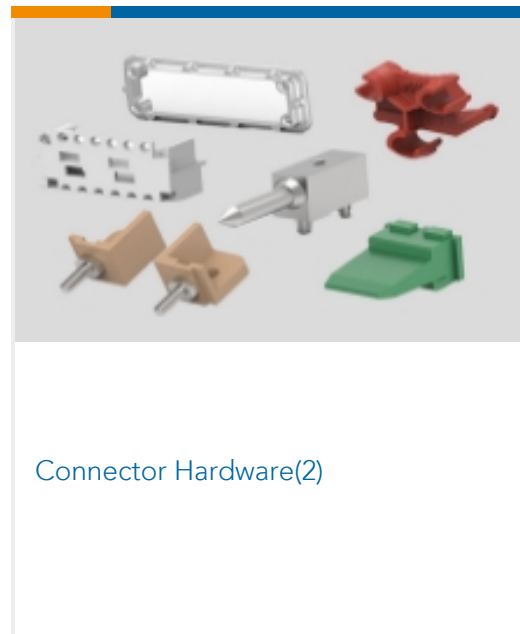
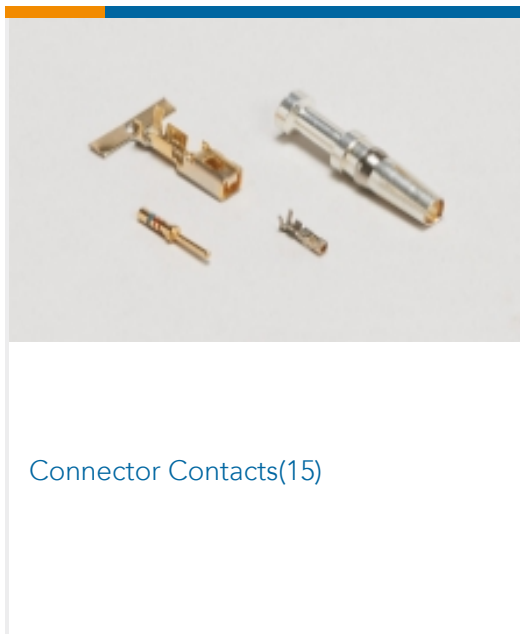

Customers Also Bought

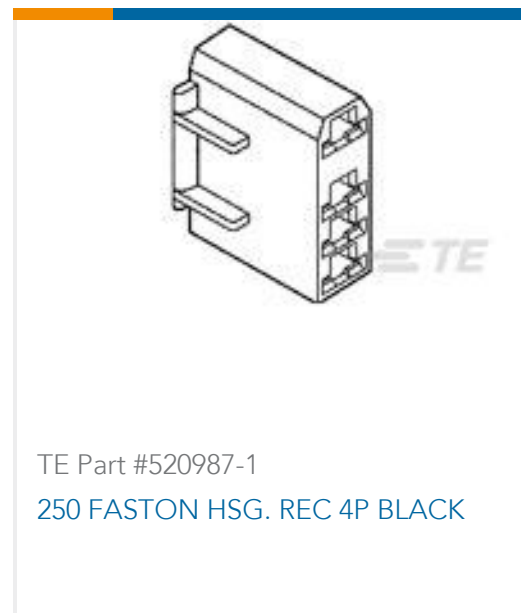



Documents

Product Drawings

[06P ECONOMY POWER .200 CL HSG](#)

English

CAD Files

[3D PDF](#)

3D

Customer View Model

[ENG_CVM_CVM_2-1744036-6_C.2d_dxf.zip](#)

English

Customer View Model

[ENG_CVM_CVM_2-1744036-6_C.3d_igs.zip](#)

English

Customer View Model

[ENG_CVM_CVM_2-1744036-6_C.3d_stp.zip](#)

English

By downloading the CAD file I accept and agree to the [Terms and Conditions](#) of use.

Datasheets & Catalog Pages

[1-1773885-9 Economy Power Connectors](#)

English

Product Specifications

[Application Specification](#)

English