

| PLUG P/N | CKT | DIM "A" | DIM "B" |
|------------|-----|---------|---------|
| 1727621002 | 2 | 5.40 | 4.95 |
| 1727621004 | 4 | 9.60 | 4.95 |
| 1727621006 | 6 | 13.80 | 4.95 |
| 1727621008 | 8 | 18.00 | 4.95 |
| 1727621010 | 10 | 22.20 | 12.95 |
| 1727621012 | 12 | 26.40 | 12.95 |
| 1727621014 | 14 | 30.60 | 12.95 |
| 1727621016 | 16 | 34.80 | 12.95 |
| 1727621018 | 18 | 39.00 | 20.95 |

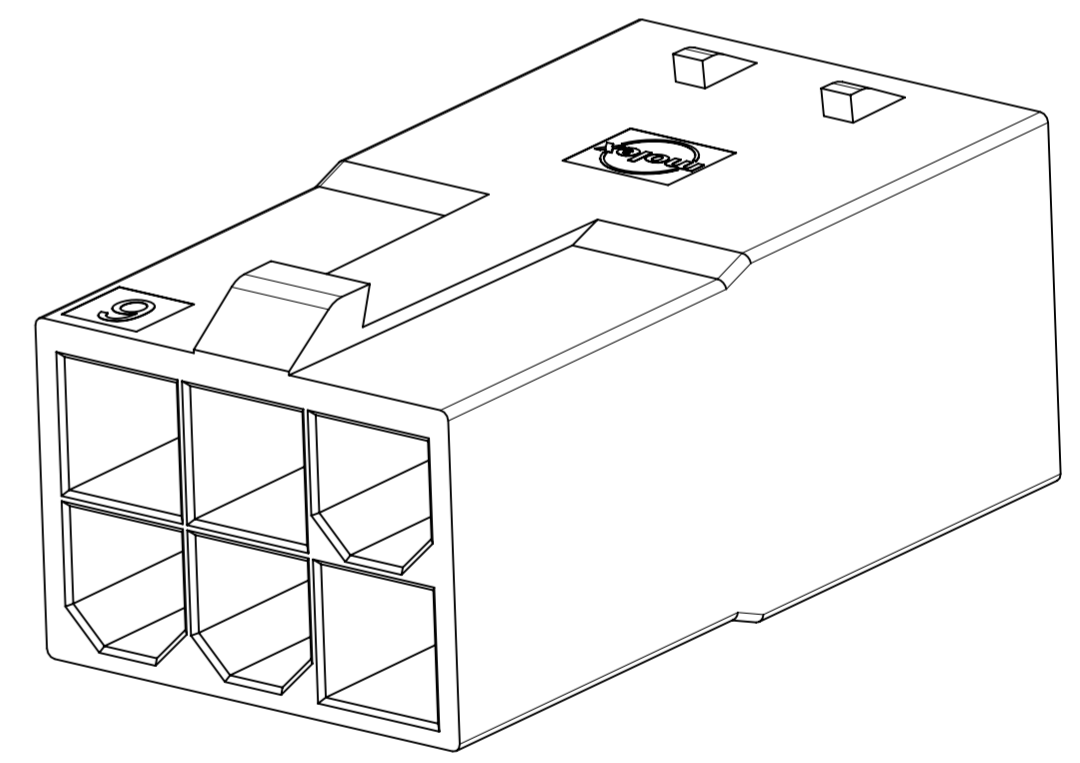
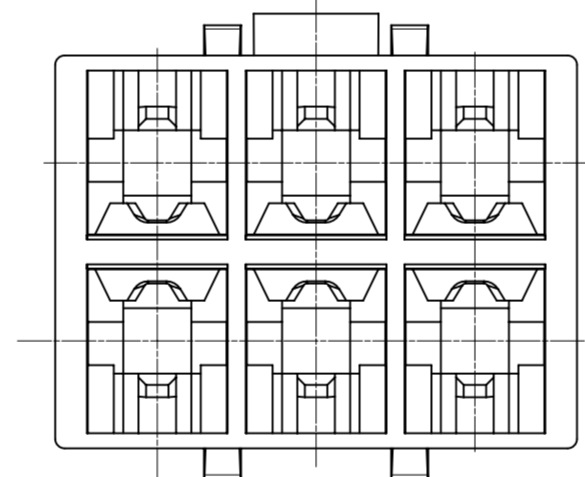
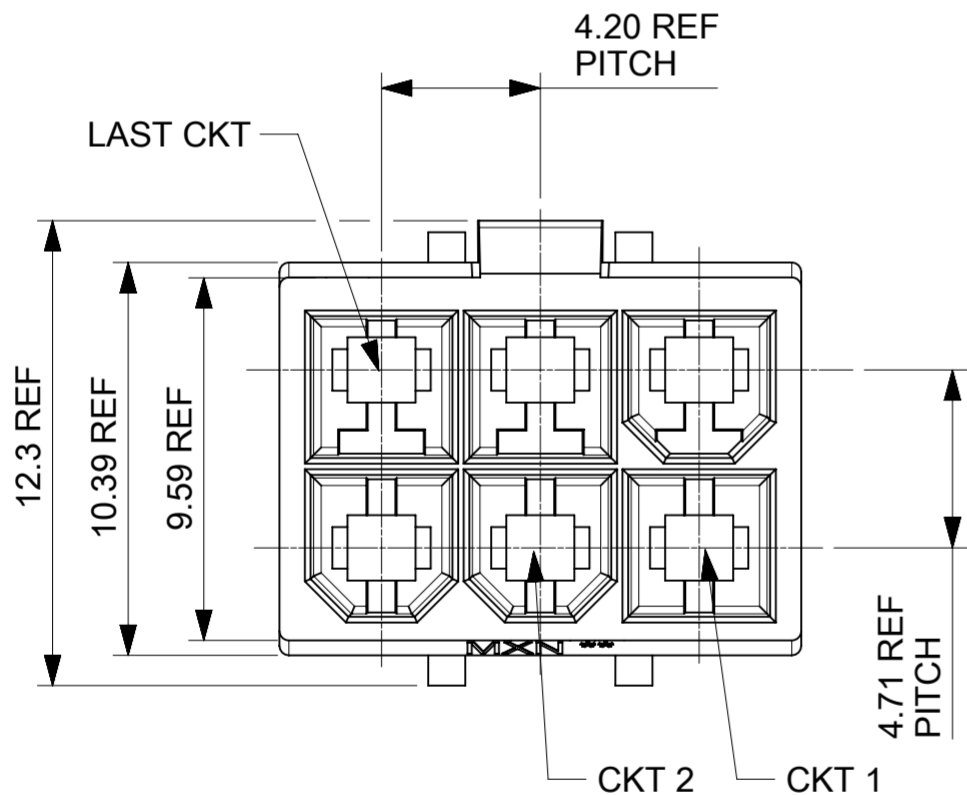

- NOTES:
1. MATERIAL: NYLON, UL 94V-0 AND GLOW WIRE CAPABLE PER IEC60335-1; COLOR: BLACK
 2. FINISH: NONE
 3. PRODUCT SPECIFICATION: 2131370000-PS/2029880002-PS
 4. APPLICATION SPECIFICATION: 2131370000-AS
 5. PACKAGING SPECIFICATION: 172762-0001-PK
 6. REFER TO AS-45499-001 FOR MOISTURIZING NYLON CONNECTOR PARTS.
 7. THIS PART TO BE USED WITH FEMALE TERMINAL SERIES 172765, 203070 AND TPA SERIES 172709-2***.
 8. THIS PART MATES WITH RECEPTACLE SERIES 172708-1***
 9. THIS PART CONFORMS TO CLASS 'B' REQUIREMENTS OF COSMETIC SPECIFICATION PS-45499-002.
 10. SEE DRAWING 1727090002-SD FOR OTHER TPA INFORMATION.
 11. SEE DRAWING 1727080002-SD FOR RECEPTACLE INFORMATION.
 12. SEE DRAWINGS SD-172718-0000 AND 2029880001-PSD FOR OTHER CRIMP TERMINAL INFORMATION.

| THIS DRAWING CONTAINS INFORMATION THAT IS PROPRIETARY TO MOLEX ELECTRONIC TECHNOLOGIES, LLC AND SHOULD NOT BE USED WITHOUT WRITTEN PERMISSION | | | | | | | | | |
|---|--------|------------------------|--|------------------|--|--------------------------------------|--|----------------------------|--|
| DIMENSION UNITS | SCALE | CURRENT REV DESC: | | | | | | | |
| mm | NTS | | | | | | | | |
| GENERAL TOLERANCES (UNLESS SPECIFIED) | | | | | | SD-DRAWING OF MINI-FIT SIGMA DR PLUG | | | |
| ANGULAR TOL | ± ° | | | | | | | | |
| 4 PLACES | ± | EC NO: 735375 | | 2023/01/06 | | PRODUCT CUSTOMER DRAWING | | | |
| 3 PLACES | ± | DRWN: JERRYW8 | | 2023/02/01 | | | | | |
| 2 PLACES | ± 0.25 | CHK'D: XQZHANG | | 2023/02/01 | | DOCUMENT NUMBER: 1727620001-SD | | | |
| 1 PLACE | ± 0.36 | APPR: XQZHANG | | 2023/02/01 | | | | | |
| 0 PLACES | ± | INITIAL REVISION: | | 2019/09/18 | | REVISION: A5 | | | |
| DRAFT WHERE APPLICABLE MUST REMAIN WITHIN DIMENSIONS | | THIRD ANGLE PROJECTION | | DRAWING: A2-SIZE | | SERIES: 172762 | | MATERIAL NUMBER: SEE TABLE | |
| | | | | | | CUSTOMER: GENERAL MARKET | | SHEET NUMBER: 1 OF 4 | |

| DOCUMENT STATUS | P1 | RELEASE DATE | 2023/02/01 | 07:45:18 |
|-----------------|----|--------------|------------|----------|
| | | | | |

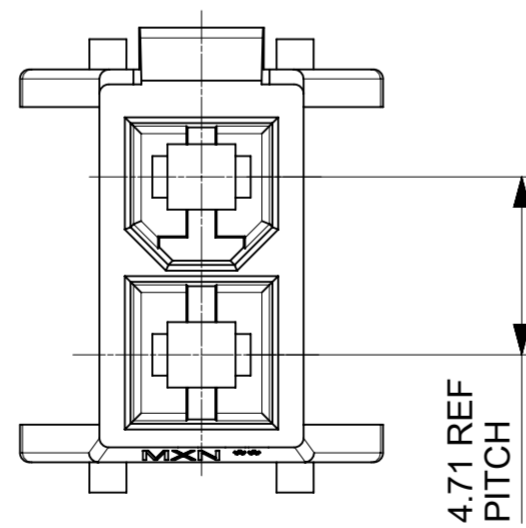
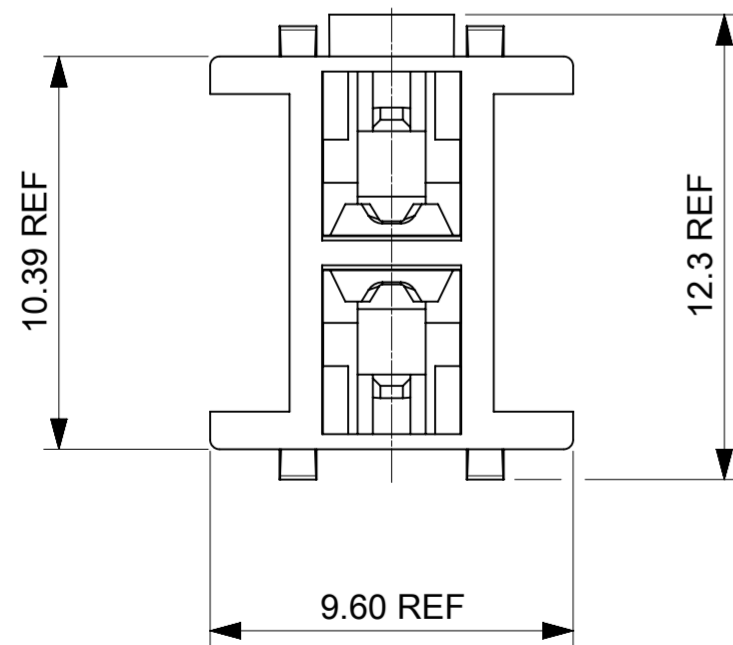
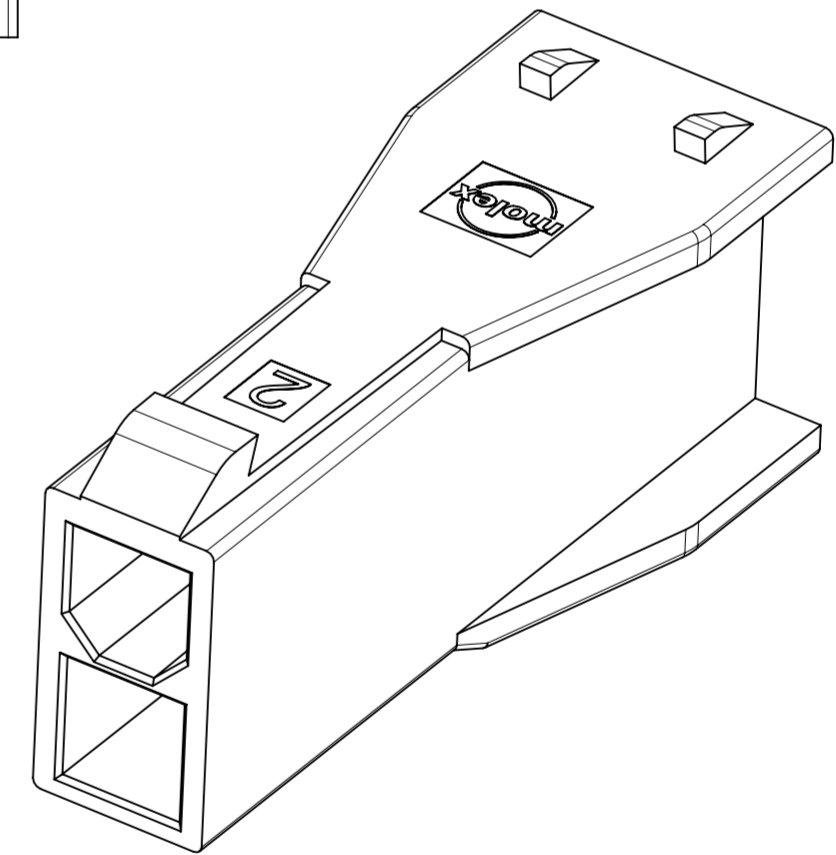
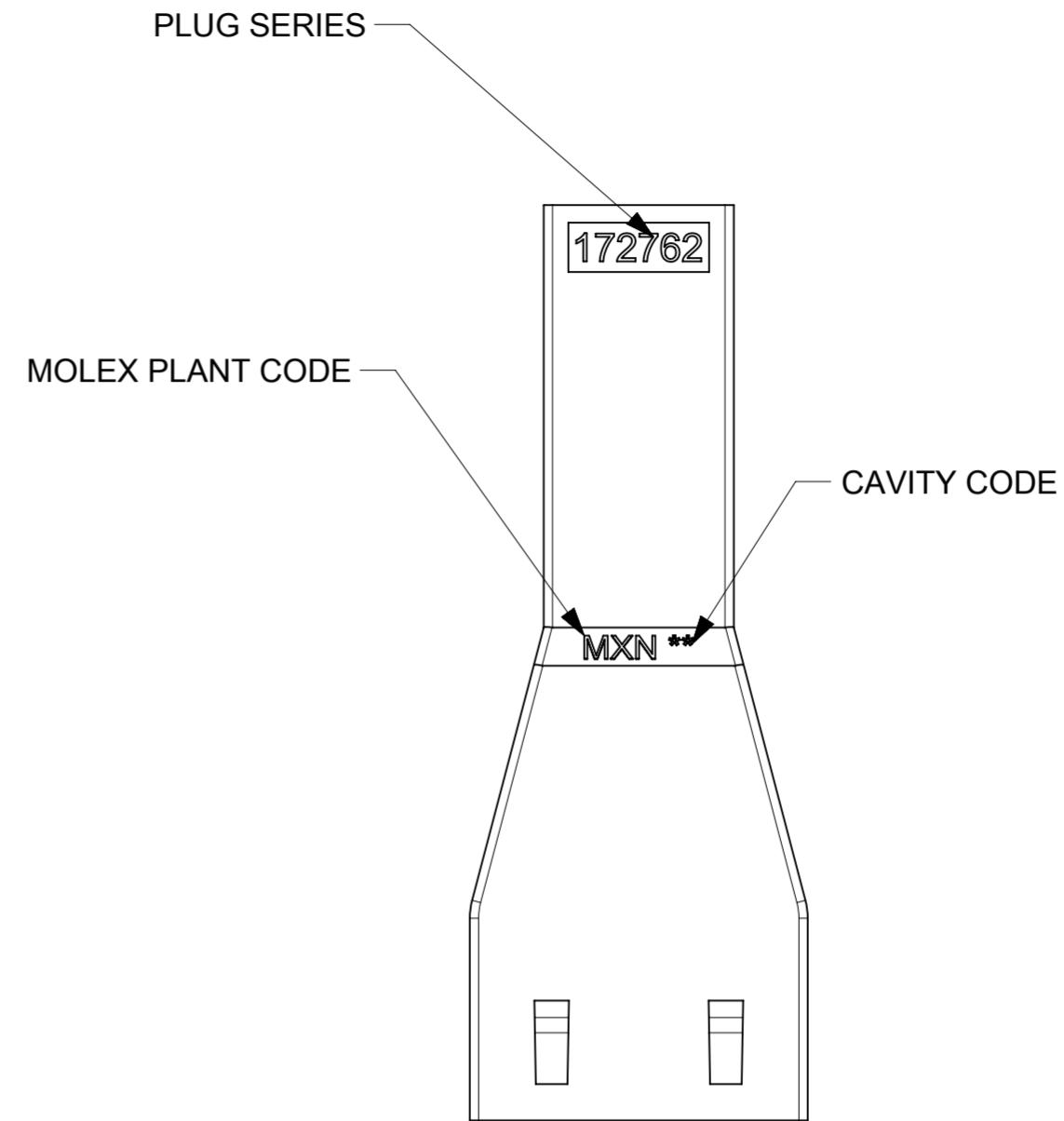
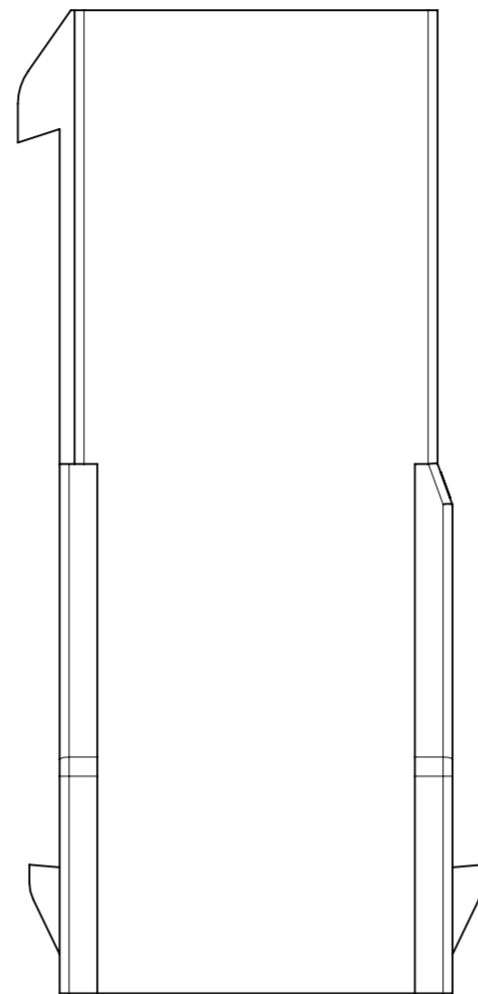
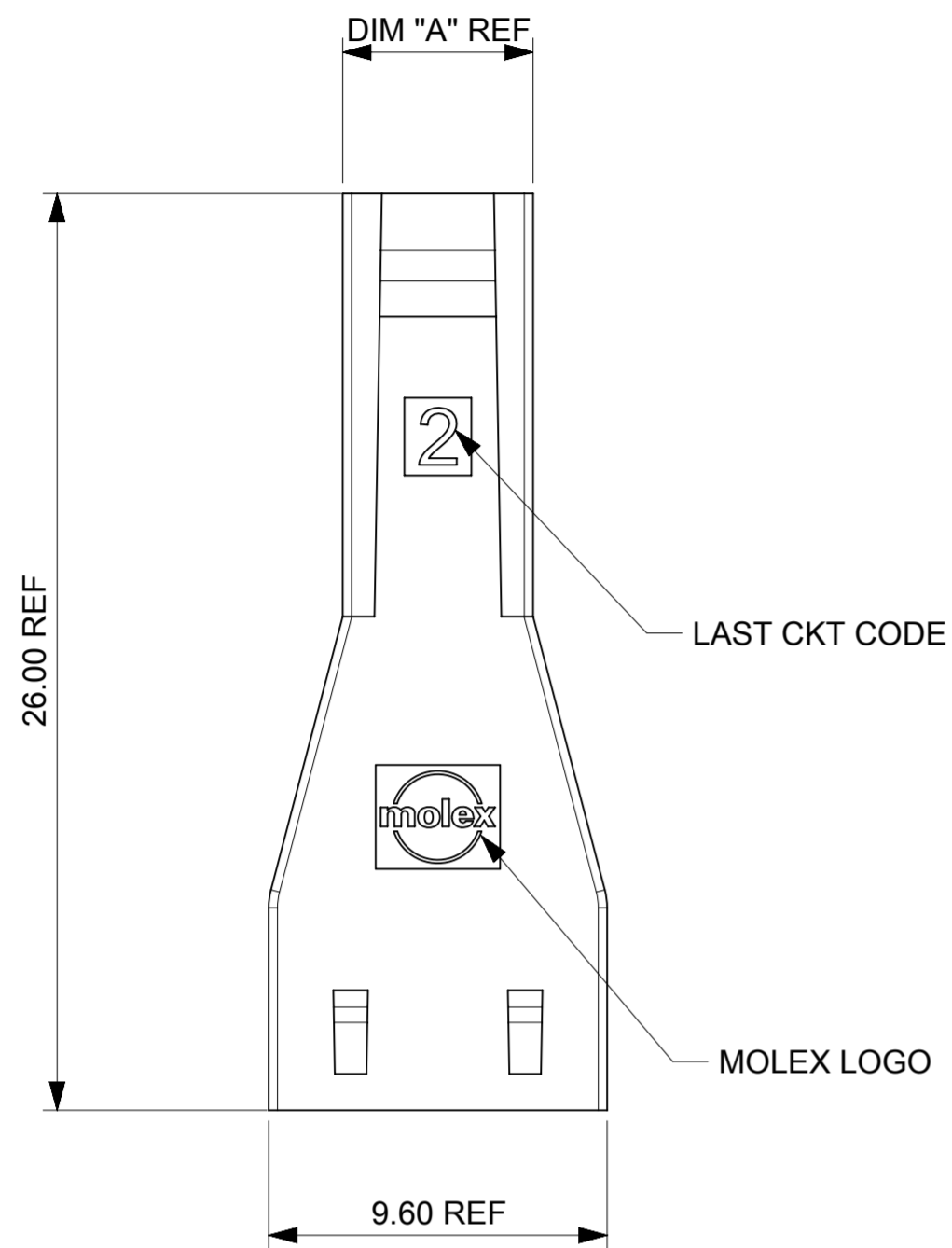

| | | | | | | | | | |
|---|--|------------------------|--|-------------------|--|------------|--|--------------------------------------|--|
| THIS DRAWING CONTAINS INFORMATION THAT IS PROPRIETARY TO MOLEX ELECTRONIC TECHNOLOGIES, LLC AND SHOULD NOT BE USED WITHOUT WRITTEN PERMISSION | | | | | | | | | |
| DIMENSION UNITS | | SCALE | | CURRENT REV DESC: | | | | molex | |
| mm | | NTS | | | | | | | |
| GENERAL TOLERANCES (UNLESS SPECIFIED) | | | | | | | | SD-DRAWING OF MINI-FIT SIGMA DR PLUG | |
| ANGULAR TOL | | ± ° | | EC NO: 735375 | | | | PRODUCT CUSTOMER DRAWING | |
| 4 PLACES | | ± | | DRWN: JERRYW8 | | 2023/01/06 | | | |
| 3 PLACES | | ± | | CHK'D: XQZHANG | | 2023/02/01 | | | |
| 2 PLACES | | ± 0.25 | | APPR: XQZHANG | | 2023/02/01 | | | |
| 1 PLACE | | ± 0.36 | | INITIAL REVISION: | | | | DOCUMENT NUMBER | |
| 0 PLACES | | ± | | DRWN: ALUO02 | | 2019/09/18 | | 1727620001-SD | |
| | | | | APPR: YXZHENG | | 2019/10/11 | | PSD 000 A5 | |
| DRAFT WHERE APPLICABLE MUST REMAIN WITHIN DIMENSIONS | | THIRD ANGLE PROJECTION | | DRAWING | | SERIES | | MATERIAL NUMBER | |
| | | | | A2-SIZE | | 172762 | | SEE TABLE | |
| | | | | GENERAL MARKET | | CUSTOMER | | SHEET NUMBER | |
| | | | | | | | | 2 OF 4 | |

| | | | | |
|-----------------|----|--------------|------------|----------|
| DOCUMENT STATUS | P1 | RELEASE DATE | 2023/02/01 | 07:45:18 |
|-----------------|----|--------------|------------|----------|

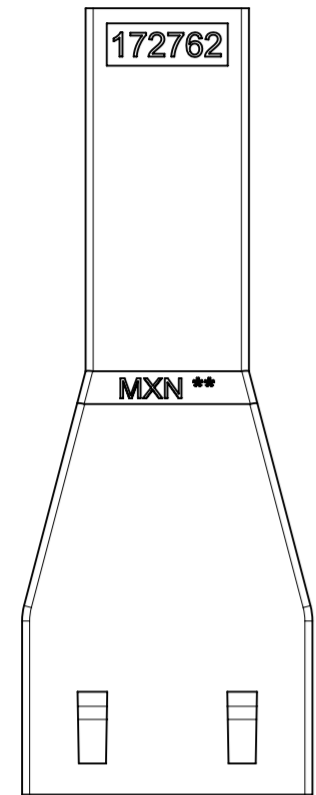
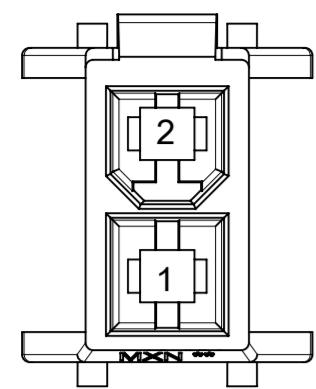

2-CKT

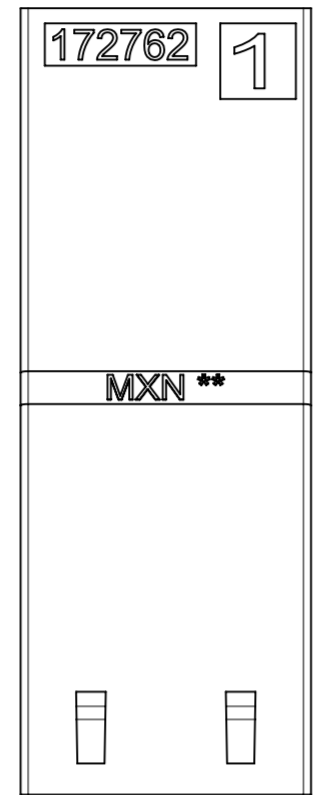
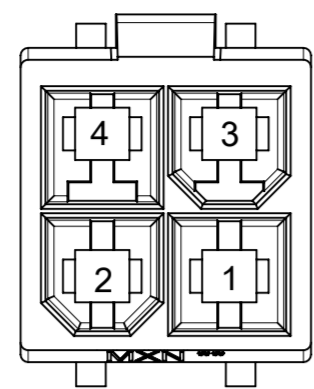

4-CKT

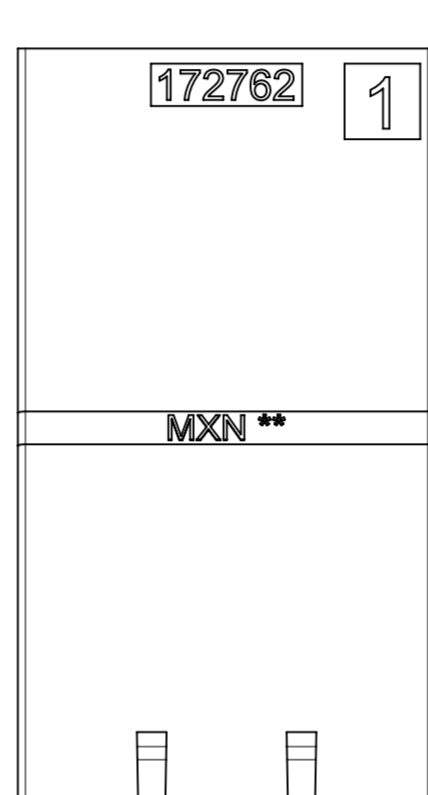
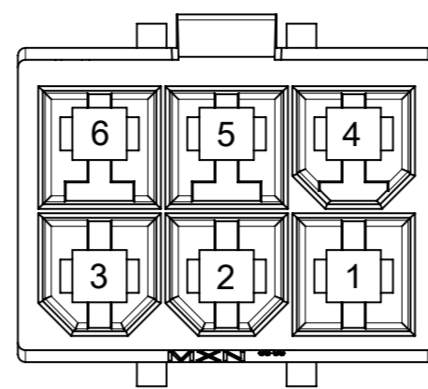

6-CKT

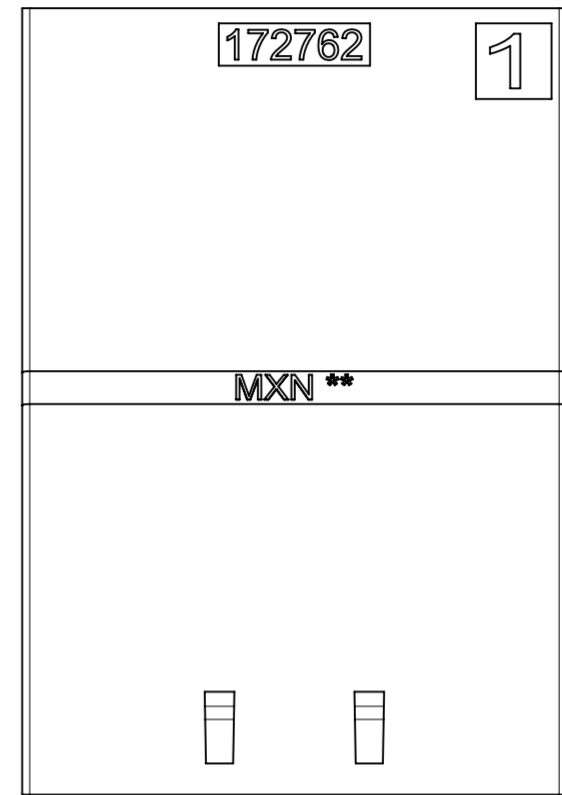
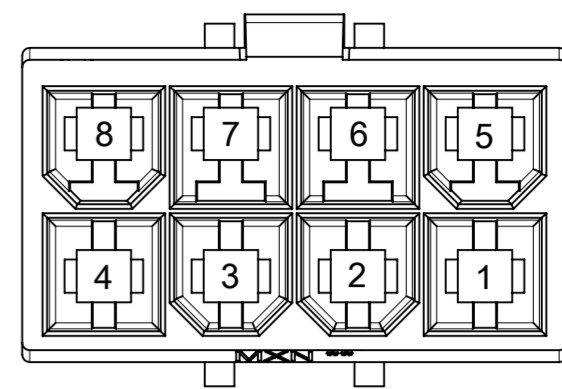

8-CKT

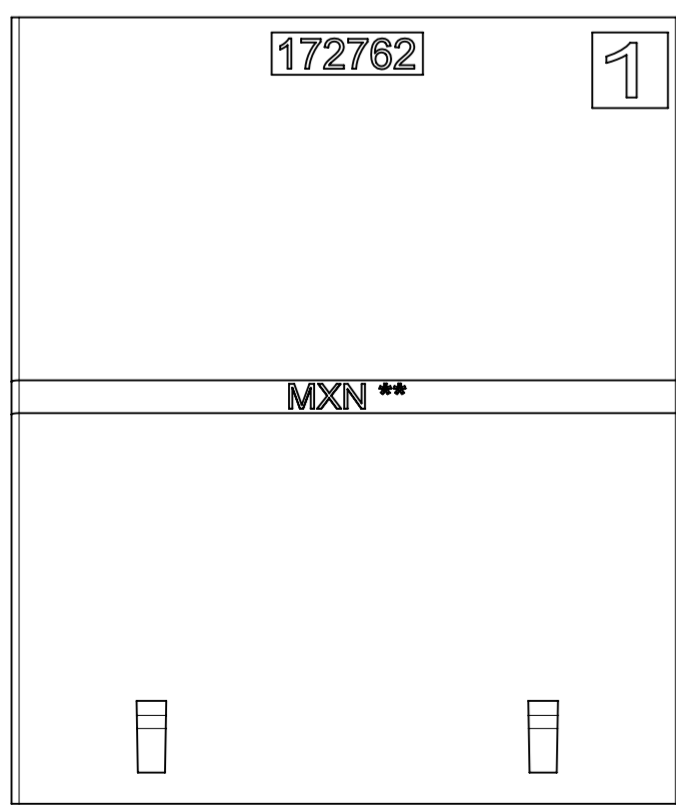
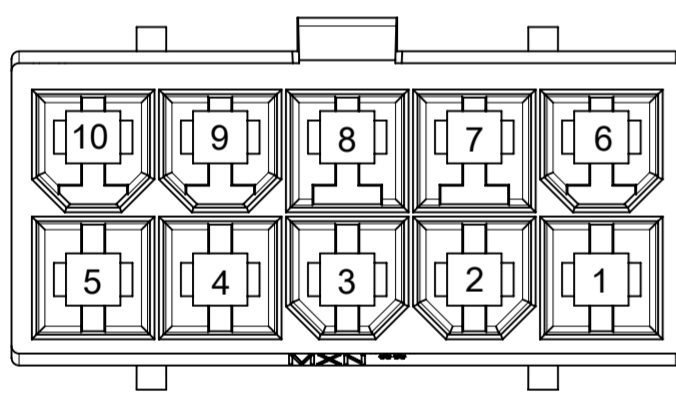

10-CKT

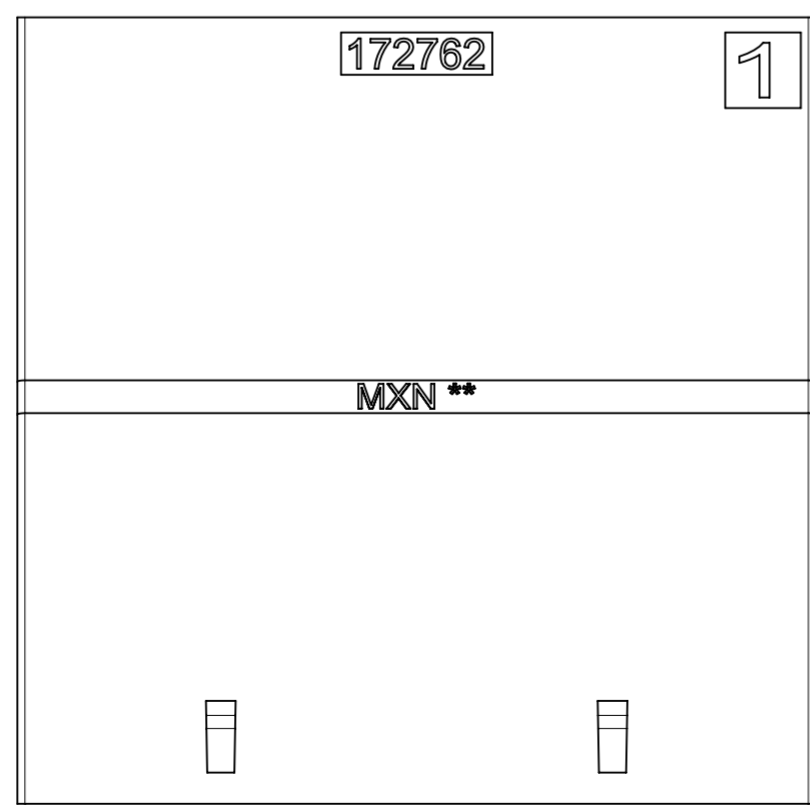
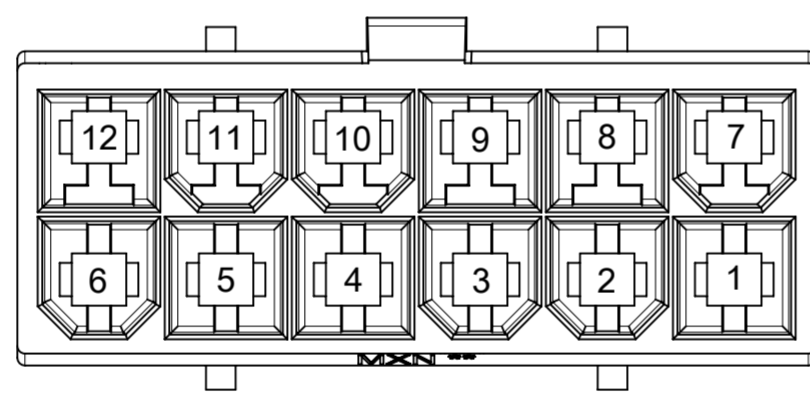

12-CKT

| | | | | | | | | | |
|---|--|------------------------|--|---------------------------|--|----------|--|--------------------------------------|--|
| THIS DRAWING CONTAINS INFORMATION THAT IS PROPRIETARY TO MOLEX ELECTRONIC TECHNOLOGIES, LLC AND SHOULD NOT BE USED WITHOUT WRITTEN PERMISSION | | | | | | | | | |
| DIMENSION UNITS | | SCALE | | CURRENT REV DESC: | | | | | |
| mm | | NTS | | | | | | | |
| GENERAL TOLERANCES (UNLESS SPECIFIED) | | | | EC NO: 735375 | | | | SD-DRAWING OF MINI-FIT SIGMA DR PLUG | |
| ANGULAR TOL ± ° | | | | DRWN: JERRYW8 2023/01/06 | | | | | |
| 4 PLACES ± | | | | CHK'D: XQZHANG 2023/02/01 | | | | PRODUCT CUSTOMER DRAWING | |
| 3 PLACES ± | | | | APPR: XQZHANG 2023/02/01 | | | | | |
| 2 PLACES ± 0.25 | | | | INITIAL REVISION: | | | | DOCUMENT NUMBER | |
| 1 PLACE ± 0.36 | | | | DRWN: ALUO02 2019/09/18 | | | | | |
| 0 PLACES ± | | | | APPR: YXZHENG 2019/10/11 | | | | 1727620001-SD | |
| DRAFT WHERE APPLICABLE MUST REMAIN WITHIN DIMENSIONS | | THIRD ANGLE PROJECTION | | DRAWING | | SERIES | | MATERIAL NUMBER | |
| | | | | A2-SIZE | | 172762 | | SEE TABLE | |
| | | | | GENERAL MARKET | | CUSTOMER | | SHEET NUMBER | |
| | | | | | | | | 3 OF 4 | |

| | | | | |
|-----------------|----|--------------|------------|----------|
| DOCUMENT STATUS | P1 | RELEASE DATE | 2023/02/01 | 07:45:18 |
|-----------------|----|--------------|------------|----------|

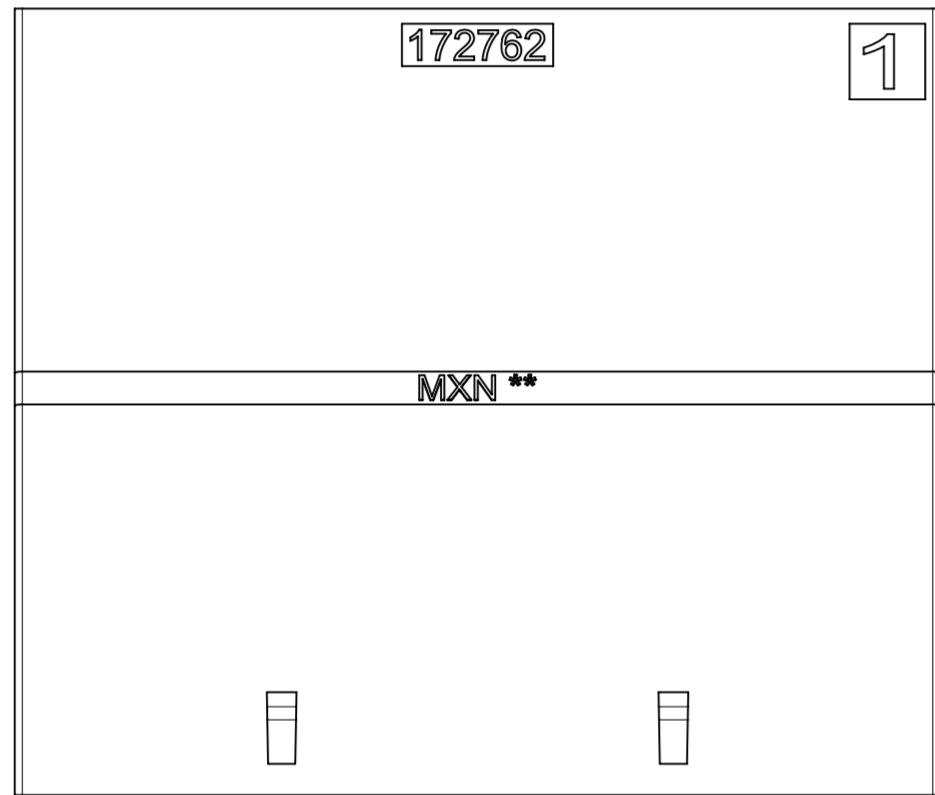
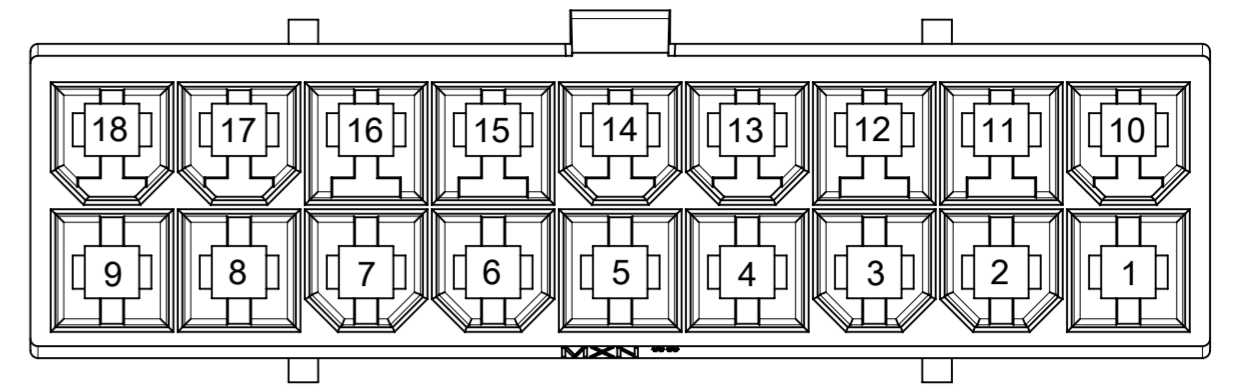
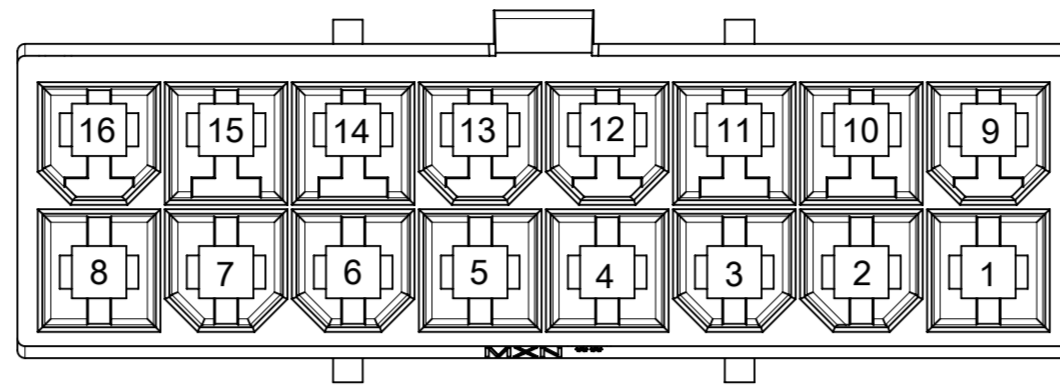
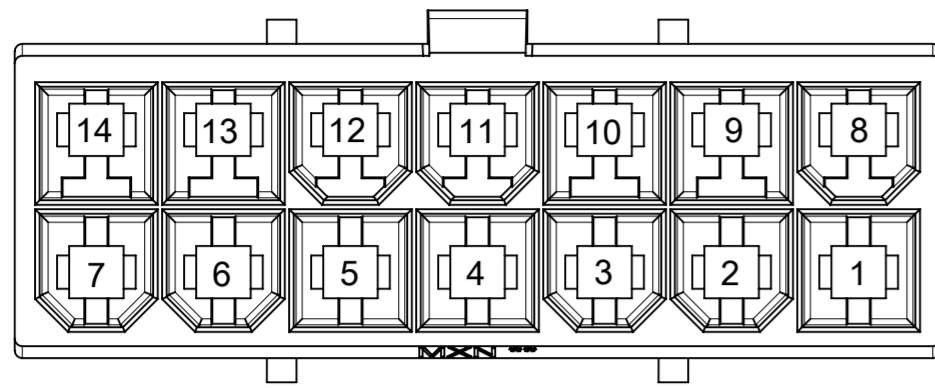

14-CKT

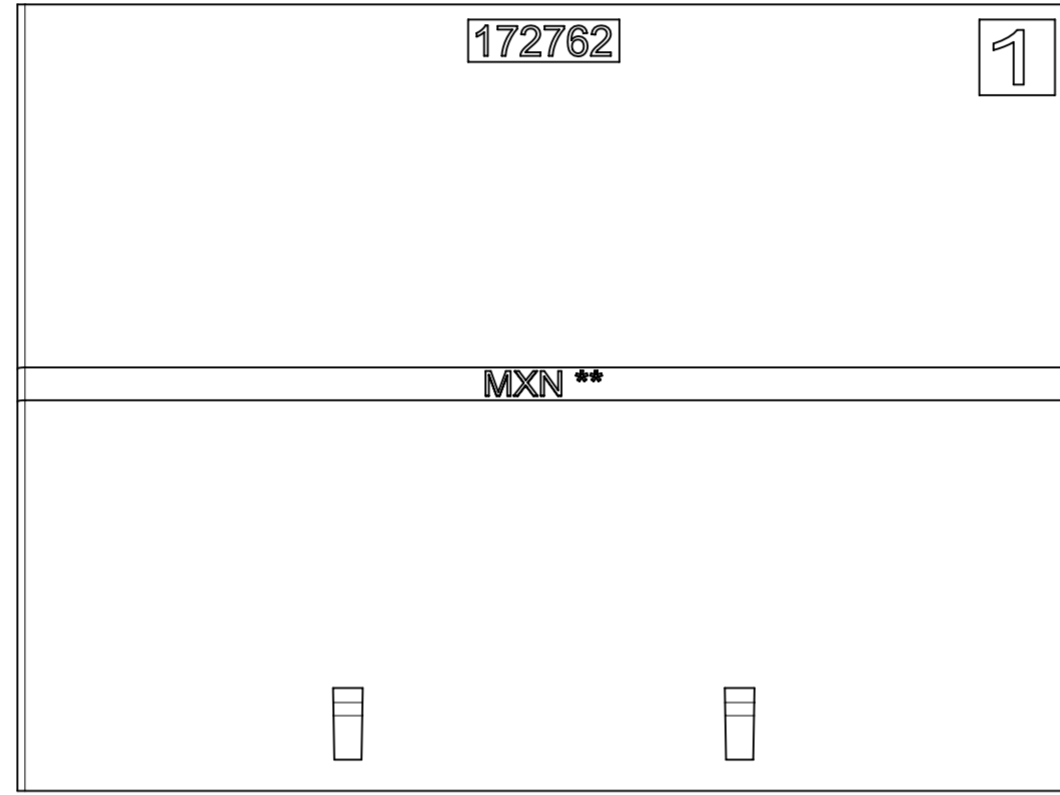

16-CKT

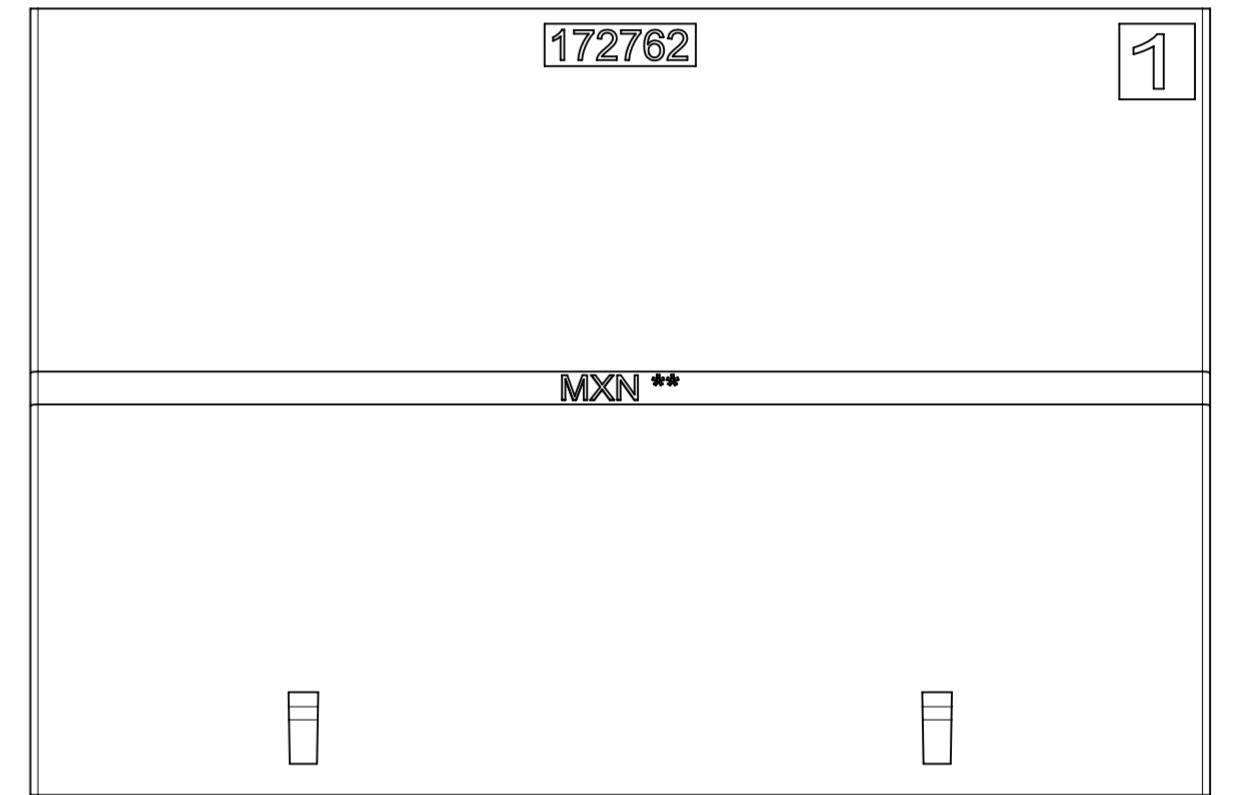

18-CKT

| | | | | | | | | | | |
|---|--------|------------------------|--|------------|--------|--------------------------------------|----------------|----------|----------|----------|
| THIS DRAWING CONTAINS INFORMATION THAT IS PROPRIETARY TO MOLEX ELECTRONIC TECHNOLOGIES, LLC AND SHOULD NOT BE USED WITHOUT WRITTEN PERMISSION | | | | | | | | | | |
| DIMENSION UNITS | SCALE | CURRENT REV DESC: | | | | molex | | | | |
| mm | NTS | | | | | | | | | |
| GENERAL TOLERANCES (UNLESS SPECIFIED) | | | | | | SD-DRAWING OF MINI-FIT SIGMA DR PLUG | | | | |
| ANGULAR TOL | ± ° | | | | | PRODUCT CUSTOMER DRAWING | | | | |
| 4 PLACES | ± | EC NO: 735375 | | 2023/01/06 | | | | | | |
| 3 PLACES | ± | DRWN: JERRYW8 | | 2023/02/01 | | | | | | |
| 2 PLACES | ± 0.25 | CHK'D: XQZHANG | | 2023/02/01 | | | | | | |
| 1 PLACE | ± 0.36 | APPR: XQZHANG | | 2023/02/01 | | | | | | |
| 0 PLACES | ± | INITIAL REVISION: | | | | DOCUMENT NUMBER | | | | |
| DRAFT WHERE APPLICABLE MUST REMAIN WITHIN DIMENSIONS | | THIRD ANGLE PROJECTION | | DRAWING | SERIES | MATERIAL NUMBER | CUSTOMER | DOC TYPE | DOC PART | REVISION |
| | | | | A2-SIZE | 172762 | SEE TABLE | GENERAL MARKET | PSD | 000 | A5 |
| SHEET NUMBER | | 4 OF 4 | | | | | | | | |