

DTM06-08SC ✓ ACTIVE

DEUTSCH | DEUTSCH DT, DEUTSCH DTM

TE Internal #: DTM06-08SC

Housing for Female Terminals, Wire-to-Wire, 8 Position, .165 in [4.19 mm] Centerline, Sealable, Green, Wire & Cable, Power & Signal, Hybrid

[View on TE.com >](#)



Connectors > Automotive Connectors > Automotive Housings > DEUTSCH DTM Housings



Connector System: **Wire-to-Wire**

Number of Positions: **8**

Connector & Housing Type: **Housing for Female Terminals**

Centerline (Pitch): **4.19 mm [.165 in]**

Sealable: **Yes**

[All DEUTSCH DTM Housings \(109\)](#)

Features

Product Type Features

Mixed & Hybrid Connector	No
Connector Shape	Rectangular
Connector System	Wire-to-Wire
Connector & Housing Type	Housing for Female Terminals
Sealable	Yes
Connector & Contact Terminates To	Wire & Cable
Primary Locking Feature	Integrated in Housing

Configuration Features

Blank Cavity Position	0
Number of Positions	8
Number of Rows	2

Electrical Characteristics

Operating Voltage	250 VAC
Nominal Voltage Architecture	12 V, 24 V, 48 V

Body Features

Cable Exit Angle	180°
------------------	------



Primary Product Color	Green
-----------------------	-------

Connector & Keying Code	C
-------------------------	---

Contact Features

Contact Size	Size 20
--------------	---------

Contact Type	Socket
--------------	--------

Mating Pin Diameter	1.02 mm[.04 in]
---------------------	-----------------

Contact Current Rating (Max)	7.5 A
------------------------------	-------

Mechanical Attachment

Terminal Position Assurance	Yes
-----------------------------	-----

Strain Relief	Add By Accessory
---------------	------------------

Mating Alignment Type	Keyed
-----------------------	-------

Mating Alignment	With
------------------	------

Connector Mounting Type	Cable Mount (Free-Hanging)
-------------------------	----------------------------

Housing Features

Housing Material	PA GF
------------------	-------

Centerline (Pitch)	4.19 mm[.165 in]
--------------------	------------------

Dimensions

Connector Height	31.62 mm[1.245 in]
------------------	--------------------

Product Width	15.24 mm[.6 in]
---------------	-----------------

Product Length	30.1 mm[1.185 in]
----------------	-------------------

Row-to-Row Spacing	7.11 mm[.28 in]
--------------------	-----------------

Compatible Insulation Diameter Range	1.35 – 3.05 mm[.053 – .12 in]
--------------------------------------	-------------------------------

Usage Conditions

Operating Temperature (Max)	125 °C[257 °F]
-----------------------------	----------------

Operating Temperature Range	-55 – 125 °C[-67 – 257 °F]
-----------------------------	----------------------------

Operation/Application

Circuit Application	Power & Signal
---------------------	----------------

Industry Standards

Degree of Protection	IP68, IP6K9K
----------------------	--------------

Compatible With Agency/Standards Products	SAE J2030
---	-----------

UL Flammability Rating	20mm Flame Test per Standard UL-94
------------------------	------------------------------------

Packaging Features



Packaging Quantity	900
--------------------	-----

Packaging Method	Box
------------------	-----

Other

Serviceable	Yes
-------------	-----

Connector Position Assurance Capable	No
--------------------------------------	----

Product Compliance

[For compliance documentation, visit the product page on TE.com>](#)

EU RoHS Directive 2011/65/EU	Compliant
------------------------------	-----------

EU ELV Directive 2000/53/EC	Compliant
-----------------------------	-----------

China RoHS 2 Directive MIIT Order No 32, 2016	No Restricted Materials Above Threshold
---	---

EU REACH Regulation (EC) No. 1907/2006	<p>Current ECHA Candidate List: JUNE 2023 (235) Candidate List Declared Against: JUNE 2023 (235) SVHC > Threshold: Octamethylcyclotetrasiloxane (D4) (.5% in Component Part) Dodecamethylcyclohexasiloxane (D6) (.5% in Component Part) Decamethylcyclopentasiloxane (D5) (.5% in Component Part)</p> <p>Article Safe Usage Statements: Wash thoroughly after handling. Recycle if possible and dispose of the article by following all applicable governmental regulations relevant to your geographic location.</p>
--	---

Halogen Content	Not Low Halogen - contains Br or Cl > 900 ppm.
-----------------	--

Solder Process Capability	Not reviewed for solder process capability
---------------------------	--

Product Compliance Disclaimer

This information is provided based on reasonable inquiry of our suppliers and represents our current actual knowledge based on the information they provided. This information is subject to change. The part numbers that TE has identified as EU RoHS compliant have a maximum concentration of 0.1% by weight in homogenous materials for lead, hexavalent chromium, mercury, PBB, PBDE, DBP, BBP, DEHP, DIBP, and 0.01% for cadmium, or qualify for an exemption to these limits as defined in the Annexes of Directive 2011/65/EU (RoHS2). Finished electrical and electronic equipment products will be CE marked as required by Directive 2011/65/EU. Components may not be CE marked. Additionally, the part numbers that TE has identified as EU ELV compliant have a maximum concentration of 0.1% by weight in homogenous materials for lead, hexavalent chromium, and mercury, and 0.01% for cadmium, or qualify for an exemption to these limits as defined in the Annexes of Directive 2000/53/EC (ELV). Regarding the REACH Regulation, the information TE provides on SVHC in articles for this part number is based on the latest European Chemicals Agency (ECHA) 'Guidance on requirements for substances in articles' posted at this URL: <https://echa.europa.eu/guidance-documents/guidance-on-reach>

Compatible Parts

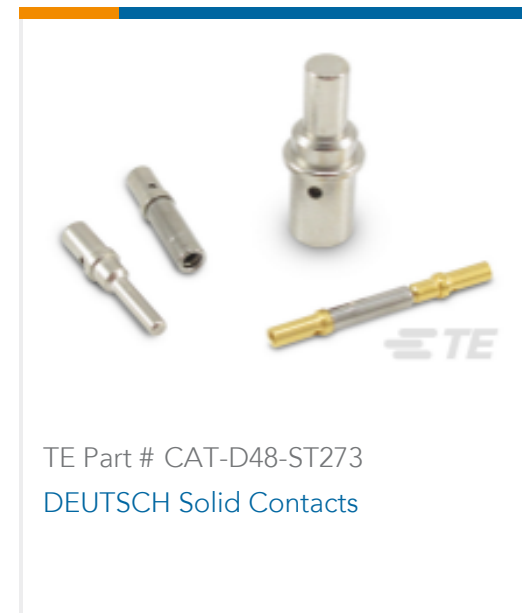

Also in the Series | **DEUTSCH DT**



Automotive Connector Caps & Covers (19)

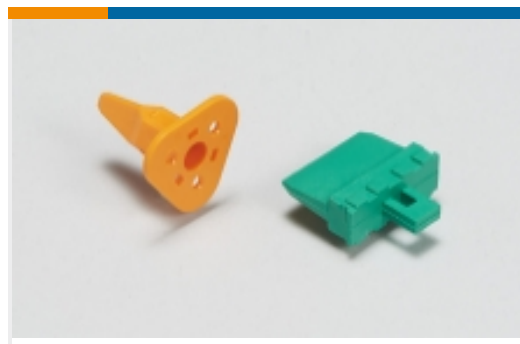

Automotive Connector Locks & Position Assurance (74)



Automotive Housings (657)



Connector Backshells (58)



Connector Seals & Cavity Plugs (6)



Connector Strain Relief (28)



Insertion & Extraction Tools (3)



Other Automotive Connector Accessories (27)

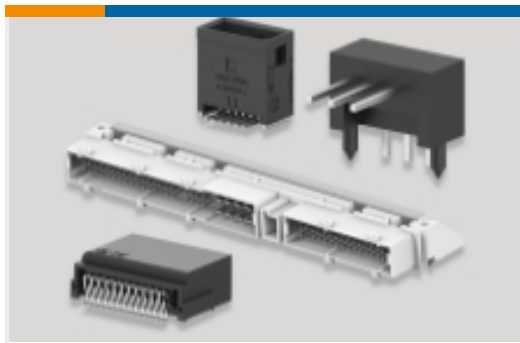

PCB Headers & Receptacles (103)

Also in the Series | DEUTSCH DTM



Automotive Connector Caps & Covers (7)

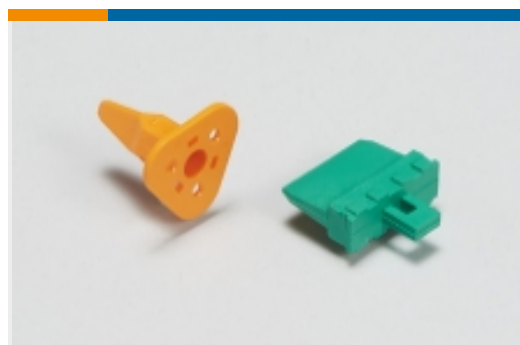

Automotive Connector Locks & Position Assurance (17)



Automotive Housings (100)



Connector Backshells (6)



Connector Strain Relief (28)



Insertion & Extraction Tools (2)

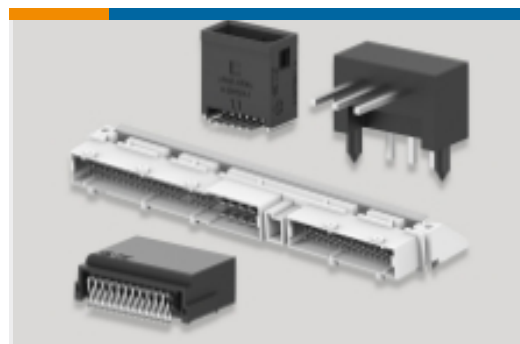

PCB Headers & Receptacles (36)

Customers Also Bought

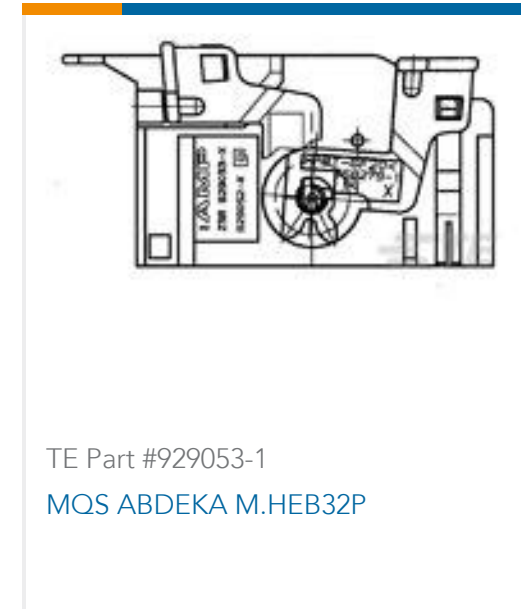
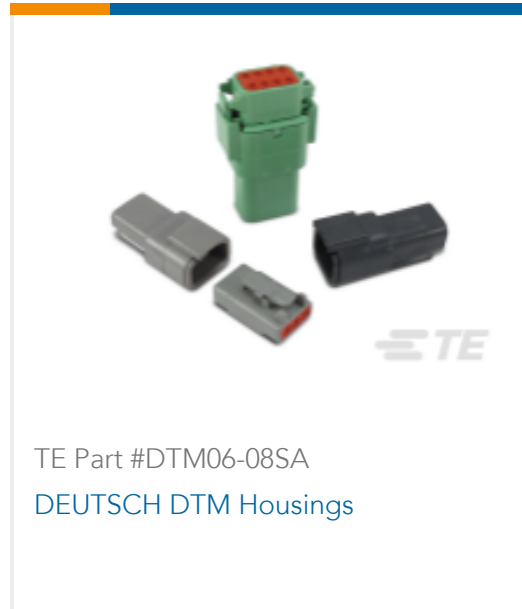

Documents

Product Drawings

PLG, 8P, GRN, N, C

English

CAD Files

3D PDF

3D

Customer View Model

[ENG_CVM_CVM_DTM06-08SC_99_c-dtm06-08sc-99.2d_dxf.zip](#)

English

Customer View Model

[ENG_CVM_CVM_DTM06-08SC_99_c-dtm06-08sc-99.3d_igs.zip](#)

English

Customer View Model

[ENG_CVM_CVM_DTM06-08SC_99_c-dtm06-08sc-99.3d_stp.zip](#)

English

By downloading the CAD file I accept and agree to the [Terms and Conditions](#) of use.

Datasheets & Catalog Pages

ICT Terminals and Connectors Catalogue

English

CONNECTOR SELECTOR

English

Product Specifications

Application Specification



English

[Agency Approvals](#)

[UL Report](#)

English