

1

2

3

4

5

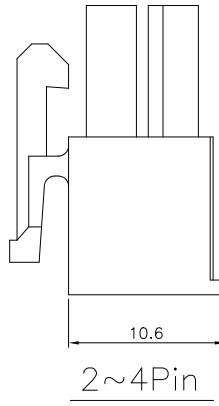
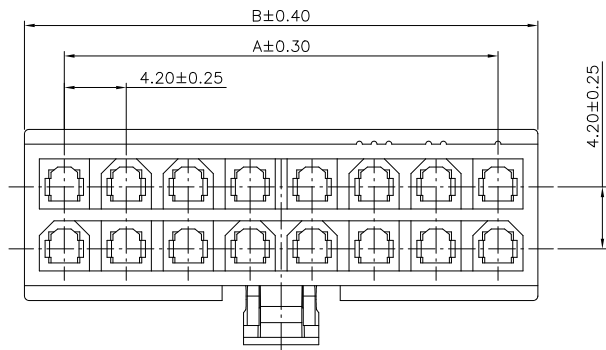

2~4Pin

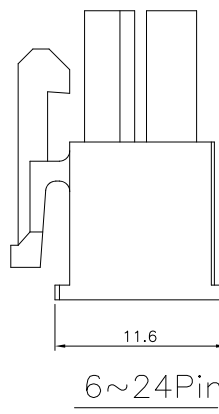
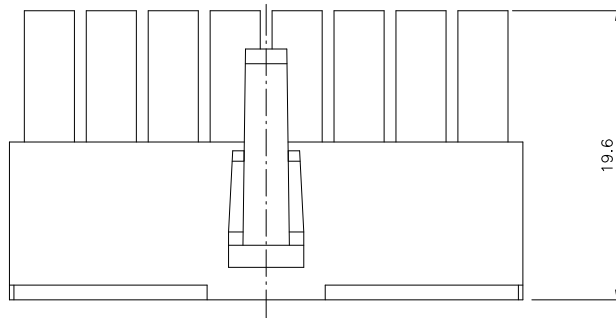

6~24Pin

Specifications:

Current Rating:4.5~12A AC/DC

Voltage Rating:600V AC/DC

Contact Resistance:10m Ohm. Max.

Insulation Resistance:1,000M Ohm. Min.

Withstanding Voltage:1500V AC/Minute

Operating Temperature Range:-40°C ~ +105°C

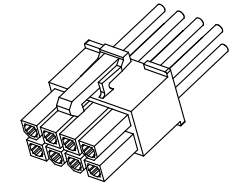

Material And Finish:

Insulator:Nylon 66 (UL94V-0)

Color:White

MAXIMUM CURRENT RATING:

WIRE-TO-WIRE						
WIRE SIZE	Dual Row Circuit Sizes					
	2	4	6,8	10,12	14,16,18	20,22,24
16 AWG	12A	11A	10A	9.5A	9A	8.5A
18 AWG	10A	9A	8A	7.5A	7A	6.5A
20 AWG	8.5A	7.5A	7A	6.5A	6A	5.5A

WIRE-TO-BOARD						
WIRE SIZE	Dual Row Circuit Sizes					
	2	4	6,8	10,12	14,16,18	20,22,24
16 AWG	11.5A	10.5A	9A	8A	7.5A	7A
18 AWG	9.5A	8.5A	7.5A	7A	6.5A	6A
20 AWG	8A	7A	6A	5.5A	5A	4.5A

Dimension:

Circuits	DIM.A	DIM.B	Circuits	DIM.A	DIM.B
2	/	5.40	14	25.20	30.60
4	4.20	9.60	16	29.40	34.80
6	8.40	13.80	18	33.60	39.00
8	12.60	18.00	20	37.80	43.20
10	16.80	22.20	22	42.00	47.40
12	21.00	26.40	24	46.20	51.60

RoHS Compliant

DRAWN:

Cherry

GENERAL TOLERANCE:

.X=±0.40

.XX=±0.30

CnC Tech

Industrial Cable and Connector Technology

CHECKED:

Dennis Lin

UNIT: MM

SCALE:1:1

DESCRIPTION:

CONN RECEPT DUAL 94V-0

SIZE

A4

APPROVAL:

Mike Wu

SHEET: 1 / 3

PROJECTION:

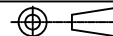

PART NO:

4281-2-XX-D

REV	DATE	FILE	BY
B	04-Dec-2023		Zongyi
A	10-Jan-2020		Cherry

A

B

C

D

1

2

3

4

5

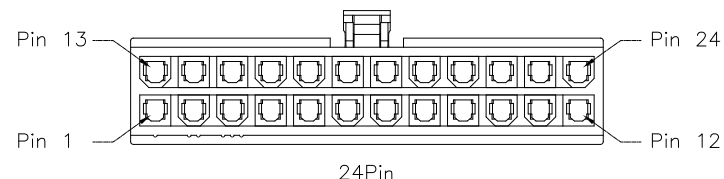
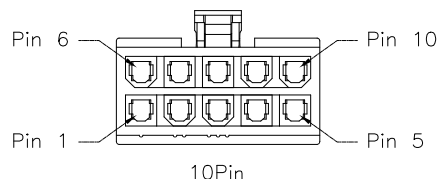
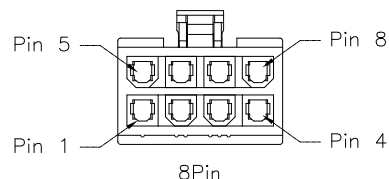
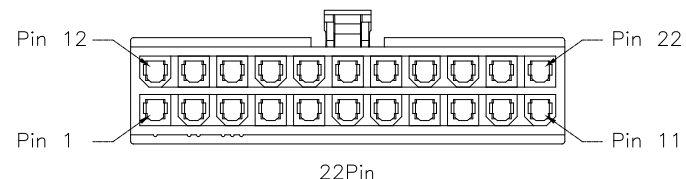
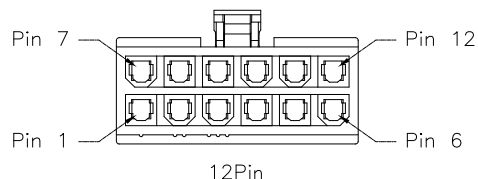
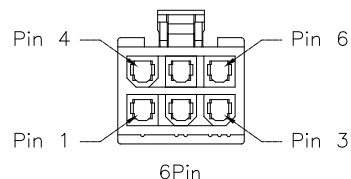
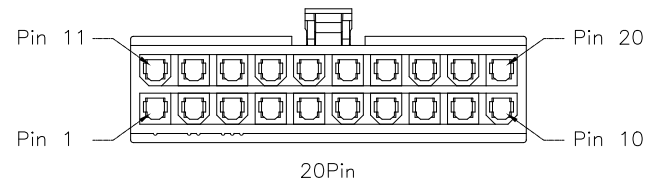
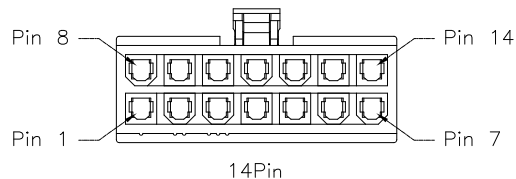
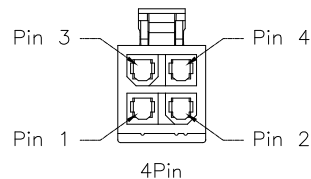
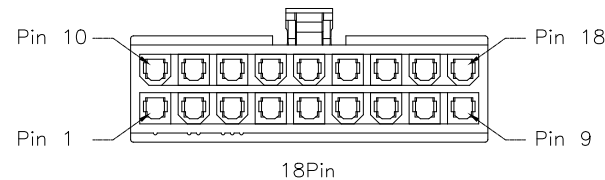
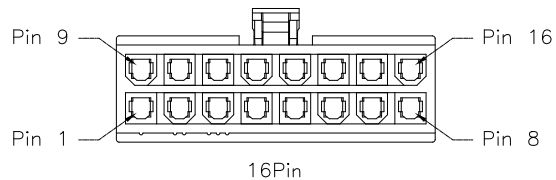
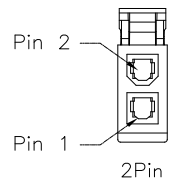

2~24Pin Drawing(Ref.)

RoHS Compliant

				DRAWN: Cherry	GENERAL TOLERANCE: .X=±0.40 .XX=±0.30	<h1 style="color: red; text-align: center;">CnC Tech</h1> <p style="text-align: center;">Industrial Cable and Connector Technology</p>	
				CHECKED: Dennis Lin	UNIT: MM SCALE:1:1		
B	04-Dec-2023		Zongyi	APPROVAL: Mike Wu	SHEET: 2 / 3	PART NO: 4281-2-XX-D	A4
REV	DATE	FILE	BY		PROJECTION:		

A

B

C

D

1

2

3

4

5

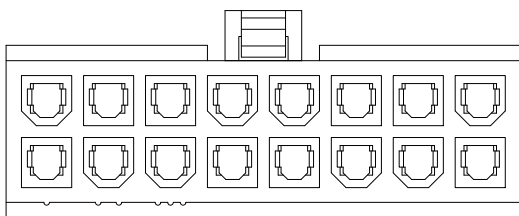

Note:
1.Dimension:
Carton Size:40*28*28(cm)

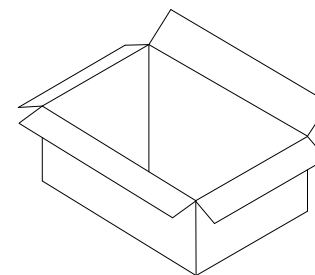
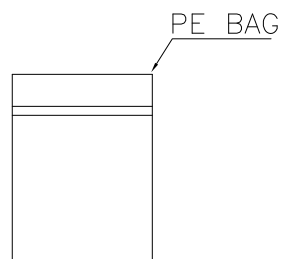
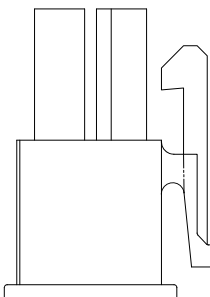
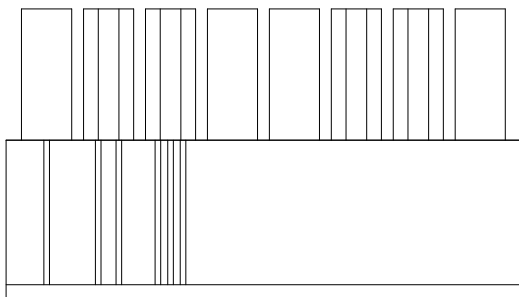

Pin.	Pcs/Bag	Pcs/Carton	Pin.	Pcs/Bag	Pcs/Carton
2	1000	14000	14	100	2000
4	200	7600	16	100	1600
6	200	4800	18	100	1600
8	200	4000	20	100	1200
10	100	3000	22	100	1200
12	100	2600	24	100	1200

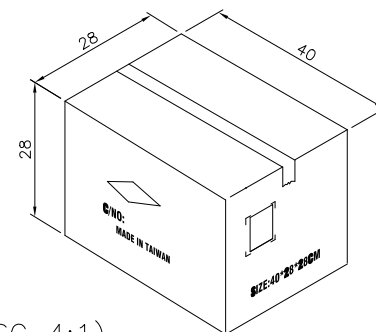
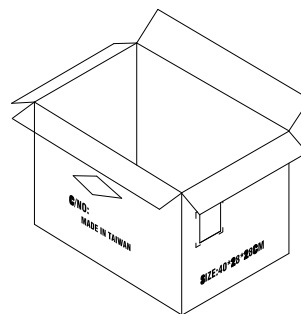

Carton (SC 4:1)

RoHS Compliant

				DRAWN: Cherry Wu	GENERAL TOLERANCE: .X=±0.20 .XX=±0.15	<h1 style="color: red; margin: 0;">CnC Tech</h1> <p style="margin: 0;">Industrial Cable and Connector Technology</p>	
				CHECKED: Dennis Lin	UNIT: MM		
B	04-Dec-2023		Zongyi	APPROVAL: Mike Wu	SCALE:1:1	PART NO: 4281-2-XX-D	A4
A	10-Jan-2020		Cherry		SHEET: 3 / 3		
REV	DATE	FILE	BY		PROJECTION:		

