

1-350779-9 ✓ ACTIVE

MATE-N-LOK | Universal MATE-N-LOK

TE Internal #: 1-350779-9

Rectangular Power Connectors, Housing, Plug, Wire-to-Board /
Wire-to-Wire, 4 Position, 6.35 mm [.25 in] Centerline, Wire & Cable,
Universal MATE-N-LOK

[View on TE.com >](#)



Connectors > Power Connectors > Rectangular Power > Rectangular Power Connectors

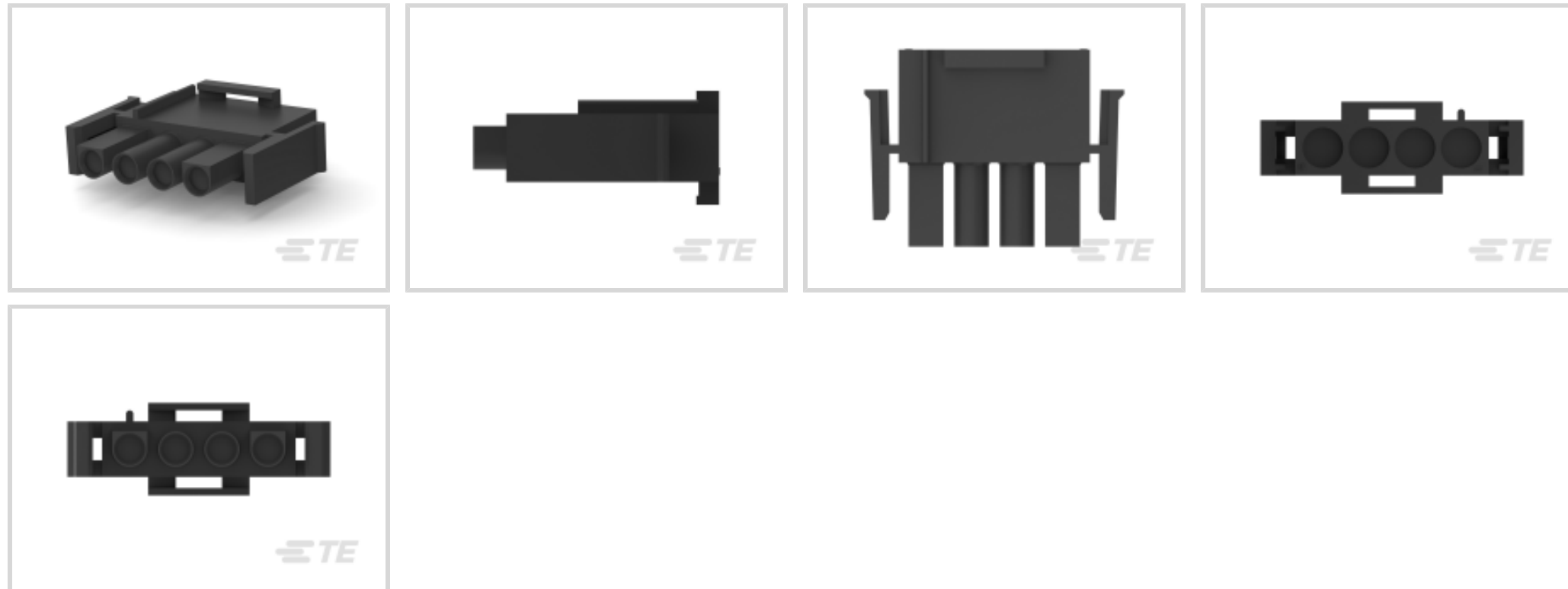

Rectangular Power Connector Type: **Housing**

Connector & Housing Type: **Plug**

Connector System: **Wire-to-Board, Wire-to-Wire**

Number of Positions: **4**

Centerline (Pitch): **6.35 mm [.25 in]**

Features

Product Type Features

Rectangular Power Connector Type	Housing
Connector & Housing Type	Plug
Connector System	Wire-to-Board, Wire-to-Wire
Sealable	No
Connector & Contact Terminates To	Wire & Cable

Configuration Features

Number of Positions	4
Number of Rows	1

Electrical Characteristics

Operating Voltage	600 VAC
-------------------	---------

Contact Features

Multiple Contact Types	Without
Contact Layout	Inline
Contact Retention Within Housing	Without



Contact Type	Socket
--------------	--------

Termination Features

Termination Method to Wire & Cable	Crimp
------------------------------------	-------

Mechanical Attachment

Connector Mounting Type	Cable Mount (Free-Hanging)
-------------------------	----------------------------

Housing Features

Centerline (Pitch)	6.35 mm [.25 in]
--------------------	------------------

Housing Color	Black
---------------	-------

Housing Material	Nylon
------------------	-------

Dimensions

	.03 – .09 in
--	--------------

Usage Conditions

Operating Temperature Range	-55 – 125 °C [-67 – 257 °F]
-----------------------------	-----------------------------

Operation/Application

Circuit Application	Power & Signal
---------------------	----------------

Industry Standards

Compatible With Agency/Standards Products	CSA, UL
---	---------

Compatible With Approved Standards Products	UL E28476
---	-----------

UL Flammability Rating	UL 94V-0
------------------------	----------

Glow Wire Rating	Standard Part - Not Glow Wire
------------------	-------------------------------

Packaging Features

Packaging Method	Package
------------------	---------

Product Compliance

[For compliance documentation, visit the product page on TE.com>](#)

EU RoHS Directive 2011/65/EU	Compliant
------------------------------	-----------

EU ELV Directive 2000/53/EC	Compliant
-----------------------------	-----------

China RoHS 2 Directive MIIT Order No 32, 2016	No Restricted Materials Above Threshold
---	---

EU REACH Regulation (EC) No. 1907/2006	Current ECHA Candidate List: JUNE 2023 (235) Candidate List Declared Against: JUNE 2023 (235) Does not contain REACH SVHC
--	---

Halogen Content

Not Low Halogen - contains Br or Cl > 900 ppm.













Solder Process Capability

Not applicable for solder process capability

Product Compliance Disclaimer

This information is provided based on reasonable inquiry of our suppliers and represents our current actual knowledge based on the information they provided. This information is subject to change. The part numbers that TE has identified as EU RoHS compliant have a maximum concentration of 0.1% by weight in homogenous materials for lead, hexavalent chromium, mercury, PBB, PBDE, DBP, BBP, DEHP, DIBP, and 0.01% for cadmium, or qualify for an exemption to these limits as defined in the Annexes of Directive 2011/65/EU (RoHS2). Finished electrical and electronic equipment products will be CE marked as required by Directive 2011/65/EU. Components may not be CE marked. Additionally, the part numbers that TE has identified as EU ELV compliant have a maximum concentration of 0.1% by weight in homogenous materials for lead, hexavalent chromium, and mercury, and 0.01% for cadmium, or qualify for an exemption to these limits as defined in the Annexes of Directive 2000/53/EC (ELV). Regarding the REACH Regulation, the information TE provides on SVHC in articles for this part number is based on the latest European Chemicals Agency (ECHA) 'Guidance on requirements for substances in articles' posted at this URL: <https://echa.europa.eu/guidance-documents/guidance-on-reach>

Compatible Parts

 <p>TE Part # 1-480703-9 04P UMNL CAP HSG BLK</p>	 <p>TE Part # 350779-4 04P UMNL PLUG HSG UL94VO</p>	 <p>TE Part # 770026-1 04P UMNLII IN-LINE CAP HSG KIT</p>	 <p>TE Part # 926299-3 5P UN-MNL STECKGEH</p>
 <p>TE Part # 2-480702-0 04P UMNL PLUG HSG NATL</p>	 <p>TE Part # 350780-1 04P UMNL CAP HSG</p>	 <p>TE Part # 350779-1 04P UMNL PLUG HSG</p>	 <p>TE Part # 1-480703-0 04P UMNL CAP HSG NATL</p>
 <p>TE Part # 1586845-1 04P UMNL CAP HSG NATL, GW</p>	 <p>TE Part # 1-480702-0 04P UMNL PLUG HSG NATL</p>	 <p>TE Part # 926305-6 UNML4WAY CAP</p>	 <p>TE Part # 794535-1 06P UMNL PLUG HSG 150C BLK</p>



TE Part # 1-1703061-2
PLUG, 2 CIRCUIT , UNIVERSAL MATE-N-LOK



TE Part # 926305-7
4P UNIV M-N-L CAP



TE Part # 1-480702-9
04P UMNL PLUG HSG BLK



TE Part # 1-480703-1
04P UMNL CAP HSG BRN



TE Part # 1-480703-2
04P UMNL CAP HSG RED



TE Part # 2-480703-0
04P UMNL CAP HSG NATL



TE Part # 794707-1
04P UMNL CAP HSG, BLACK



TE Part # 770049-1
04P UMNL II CAP-FRONT 94VO

Also in the Series | **Universal MATE-N-LOK**



Circular Power Connectors(2)



Connector Caps & Covers(34)



Connector Contacts(209)



Connector Hardware(12)



Connector Seals & Cavity Plugs(27)



Connector Strain Relief(7)



Insertion & Extraction Tools(4)



Rectangular Connector Housings(1)



Rectangular Power Connectors(672)

Customers Also Bought

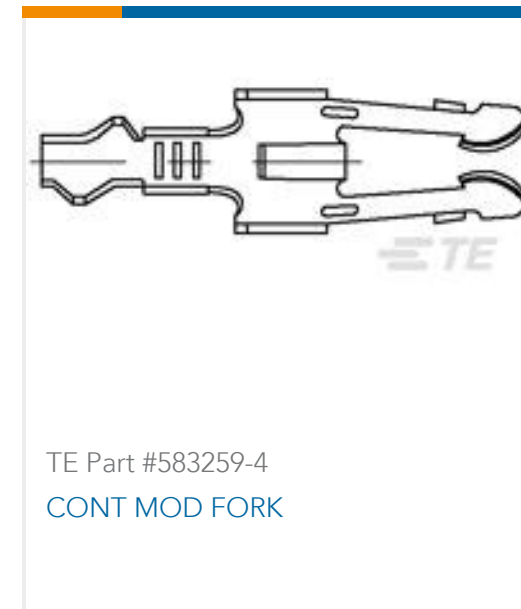
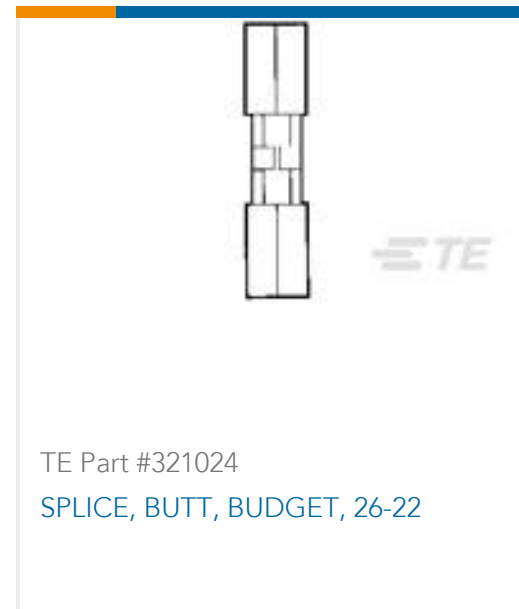

Documents

Product Drawings

04P UMNL V0 PLUG HSG BLACK

English

CAD Files

3D PDF

English

Customer View Model

[ENG_CVM_1-350779-9_AB1.2d_dxf.zip](#)

English

Customer View Model

[ENG_CVM_1-350779-9_AB1.3d_igs.zip](#)

English

Customer View Model

[ENG_CVM_1-350779-9_AB1.3d_stp.zip](#)

English

3D PDF

3D

Customer View Model

[ENG_CVM_CVM_1-350779-9_BA.2d_dxf.zip](#)

English

Customer View Model

[ENG_CVM_CVM_1-350779-9_BA.3d_igs.zip](#)

English

Customer View Model

[ENG_CVM_CVM_1-350779-9_BA.3d_stp.zip](#)

English



By downloading the CAD file I accept and agree to the [Terms and Conditions](#) of use.

Datasheets & Catalog Pages

[SOFT_SHELL_PIN_SOCKET_CONNECTORS_STANDARD_DENSITY](#)

English

Product Specifications

[Application Specification](#)

English

Instruction Sheets

[Instruction Sheet \(U.S.\)](#)

English

Agency Approvals

[VDE Certificate](#)

English