

2320916-1 ✓ ACTIVE

AMP | AMPSEAL 16

TE Internal #: 2320916-1

Housing for Male Terminals, Wire-to-Wire / Wire-to-Device, 6  
Position, .177 in [4.5 mm] Centerline, Sealable, Gray, Wire & Cable,  
AMPSEAL 16

[View on TE.com >](#)



Connectors > Automotive Connectors > Automotive Housings > AMPSEAL 16 Housings



Connector System: **Wire-to-Device, Wire-to-Wire**

Number of Positions: **6**

Connector & Housing Type: **Housing for Male Terminals**

Centerline (Pitch): **4.5 mm [ .177 in ]**

Sealable: **Yes**

[All AMPSEAL 16 Housings \(226\)](#)

## Features

### Product Type Features

Mixed & Hybrid Connector	No
Connector Shape	Rectangular
Connector System	Wire-to-Device, Wire-to-Wire
Connector & Housing Type	Housing for Male Terminals
Sealable	Yes
Connector & Contact Terminates To	Wire & Cable
Primary Locking Feature	Integrated in Housing

### Configuration Features

Blank Cavity Position	0
Number of Positions	6
Number of Rows	2

### Electrical Characteristics



Operating Voltage	250 VAC
-------------------	---------

Nominal Voltage Architecture	12 V
------------------------------	------

### Body Features

Cable Exit Angle	180°
------------------	------

Primary Product Color	Gray
-----------------------	------

Connector & Keying Code	1
-------------------------	---

### Contact Features

Contact Size	Size 16
--------------	---------

Contact Type	Pin
--------------	-----

Mating Pin Diameter	1.59 mm [.062 in]
---------------------	-------------------

Contact Current Rating (Max)	13 A
------------------------------	------

### Mechanical Attachment

Terminal Position Assurance	Yes
-----------------------------	-----

Strain Relief	Add By Accessory
---------------	------------------

Mating Alignment Type	Keyed
-----------------------	-------

Mating Alignment	With
------------------	------

Connector Mounting Type	Cable Mount (Free-Hanging)
-------------------------	----------------------------

### Housing Features

Housing Material	PBT GF
------------------	--------

Centerline (Pitch)	4.5 mm [.177 in]
--------------------	------------------

### Dimensions

Connector Height	26.65 mm [1.049 in]
------------------	---------------------

Product Width	24.6 mm [.969 in]
---------------	-------------------

Product Length	47.55 mm [1.872 in]
----------------	---------------------

Row-to-Row Spacing	5.3 mm [.209 in]
--------------------	------------------

### Usage Conditions

Operating Temperature (Max)	70 °C, 75 °C, 80 °C, 85 °C, 90 °C, 100 °C, 105 °C, 110 °C, 120 °C, 125 °C, 130 °C, 140 °C, 145 °C, 150 °C [158 °F] [167 °F] [176 °F] [185 °F] [194 °F] [212 °F] [221 °F] [230 °F] [248 °F] [257 °F] [266 °F] [284 °F] [293 °F] [302 °F]
-----------------------------	---

Operating Temperature Range	-40 – 150 °C [-40 – 302 °F]
-----------------------------	-----------------------------

### Operation/Application



Circuit Application	Power, Signal
---------------------	---------------

**Industry Standards**

Degree of Protection	IP67
UL Flammability Rating	UL 94V-0

**Packaging Features**

Packaging Method	Box
------------------	-----

**Other**

Serviceable	Yes
Connector Position Assurance Capable	Yes

**Product Compliance**

[For compliance documentation, visit the product page on TE.com>](#)

EU RoHS Directive 2011/65/EU	Compliant
EU ELV Directive 2000/53/EC	Compliant
China RoHS 2 Directive MIIT Order No 32, 2016	No Restricted Materials Above Threshold

EU REACH Regulation (EC) No. 1907/2006	<p>Current ECHA Candidate List: JUNE 2023 (235)                  Candidate List Declared Against: JUNE 2023 (235)                  SVHC &gt; Threshold:                  Octamethylcyclotetrasiloxane (D4) (.5% in Component part)                  Decamethylcyclopentasiloxane (D5) (.5% in Component part)                  Dodecamethylcyclohexasiloxane (D6) (.5% in Component part)</p> <p><b>Article Safe Usage Statements:</b>                  Wash thoroughly after handling. Recycle if possible and dispose of the article by following all applicable governmental regulations relevant to your geographic location.</p>
--	---

Halogen Content	Not Low Halogen - contains Br or Cl > 900 ppm.
-----------------	--

Solder Process Capability	Not reviewed for solder process capability
---------------------------	--

**Product Compliance Disclaimer**

This information is provided based on reasonable inquiry of our suppliers and represents our current actual knowledge based on the information they provided. This information is subject to change. The part numbers that TE has identified as EU RoHS compliant have a maximum concentration of 0.1% by weight in homogenous materials for lead, hexavalent chromium, mercury, PBB, PBDE, DBP, BBP, DEHP, DIBP, and 0.01% for cadmium, or qualify for an exemption to these limits as defined in the Annexes of Directive 2011/65/EU (RoHS2). Finished electrical and electronic equipment products will be CE marked as required by Directive 2011/65/EU. Components may not be CE marked. Additionally, the part numbers that TE has identified as EU ELV compliant have a maximum concentration of 0.1% by weight in homogenous materials for lead, hexavalent chromium, and mercury, and 0.01% for cadmium, or qualify for an exemption to these limits as defined in the Annexes of Directive 2000/53/EC (ELV). Regarding the REACH Regulation, the information TE provides

on SVHC in articles for this part number is based on the latest European Chemicals Agency (ECHA) 'Guidance on requirements for substances in articles' posted at this URL: <https://echa.europa.eu/guidance-documents/guidance-on-reach>

## Compatible Parts



TE Part # CAT-AM7801-T273  
Contacts: Size 16, 13A



TE Part # CAT-AM7801-B128  
AMPSEAL 16 Connectors Backshell



TE Part # 776363-1  
SEALING PLUG, SZ 16 CAVITY



TE Part # CAT-AM7801-CH8172  
AMPSEAL 16 Housings

## Also in the Series | AMPSEAL 16



Automotive Connector Caps & Covers (1)

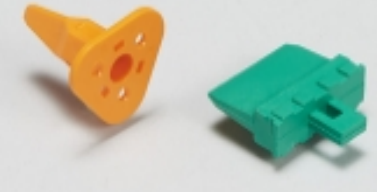

Automotive Connector Locks & Position Assurance(2)



Automotive Housings(244)

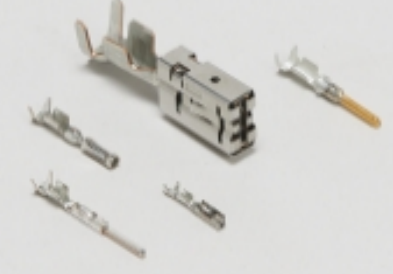

Automotive Terminals(33)



Connector Backshells(84)



Connector Seals & Cavity Plugs(4)



Data Connectivity Headers(2)



Data Connectivity Housings(3)



Other Automotive Connector Accessories(11)

## Customers Also Bought



TE Part #DT04-4P-CE01  
REC, 4P, GRY, E, CAP



TE Part #776531-1  
AMPSEAL 16 Housings



TE Part #776364-1  
SEALING PLUG, SZ 20 CAVITY

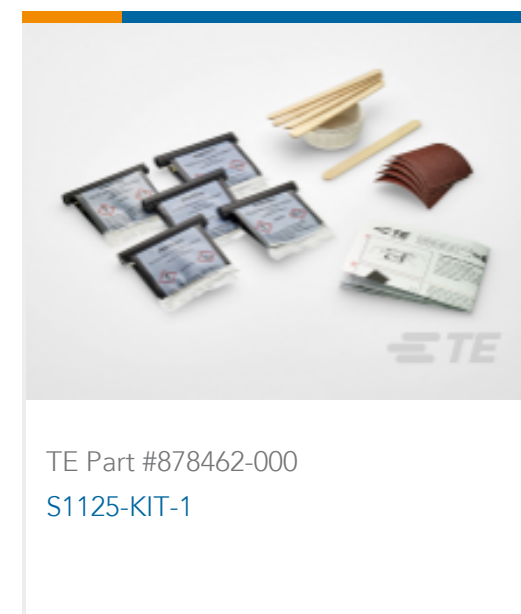

TE Part #878462-000  
S1125-KIT-1

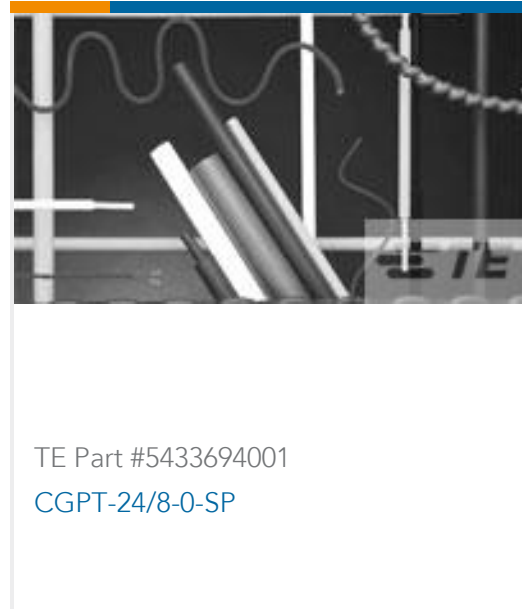

TE Part #5433694001  
CGPT-24/8-0-SP

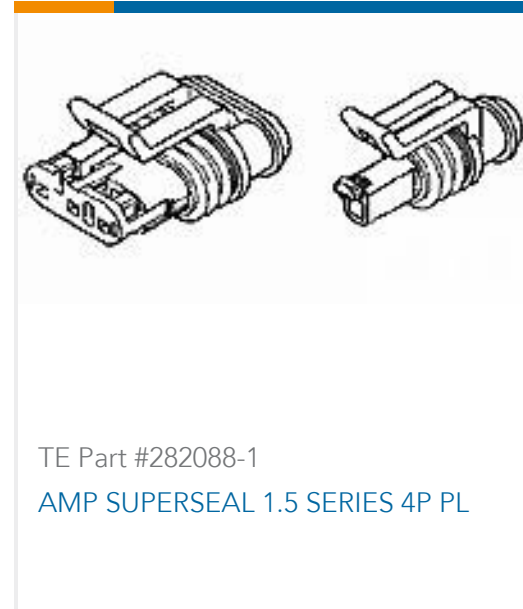

TE Part #282088-1  
AMP SUPERSEAL 1.5 SERIES 4P PL



TE Part #2292863-1  
AMPSEAL 16 Connectors Backshell

## Documents

### Product Drawings

6POS,AMPSEAL 16,PIN HSG ASSY,SLD,COD 1

English

### CAD Files

3D PDF

3D

Customer View Model

[ENG\\_CVM\\_CVM\\_2320916-1\\_A.2d\\_dxf.zip](#)

English

Customer View Model

[ENG\\_CVM\\_CVM\\_2320916-1\\_A.3d\\_igs.zip](#)

English

Customer View Model

[ENG\\_CVM\\_CVM\\_2320916-1\\_A.3d\\_stp.zip](#)

English

By downloading the CAD file I accept and agree to the [Terms and Conditions](#) of use.

### Product Specifications

[Application Specification](#)

English