

REVISIONS					
REV	ECO	DESCRIPTION	DATE	BY	APPR
A1	-	RELEASE NUMBER	27/JUL/2021	LOUIE	TOMMY

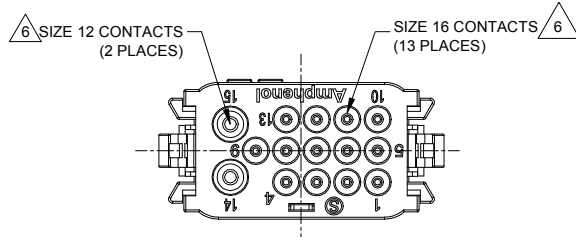
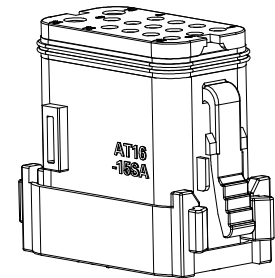
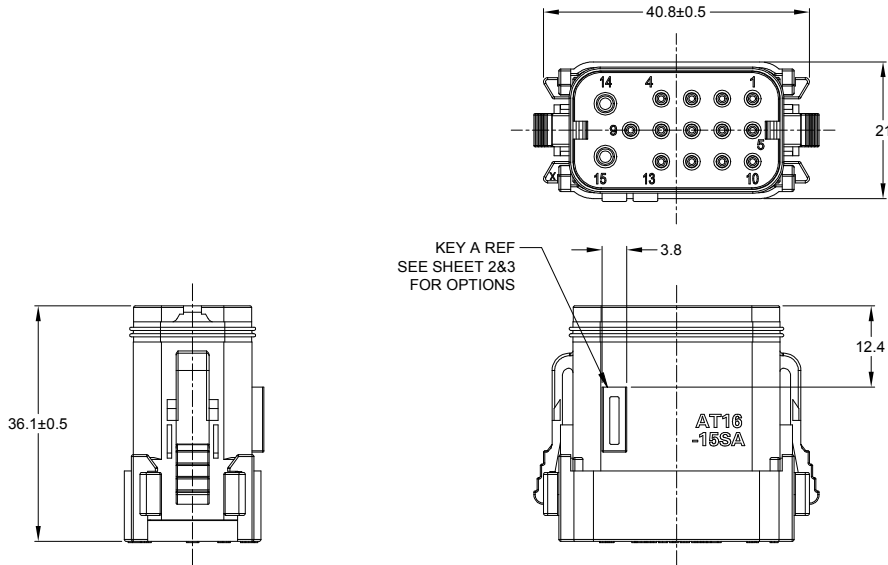

CONTACT SIZE	MIN. INSUL O.D.	MAX. INSUL O.D.	TYPICAL WIRE RANGE
12	2.46 mm (.097 in)	4.01 mm (.158 in)	10 - 14 AWG (3.0-2.0)
16	1.35 mm (.053 in)	3.05 mm (.120 in)	14 - 20 AWG (2.0-0.5)

NOTES: UNLESS OTHERWISE SPECIFIED

- MATERIAL:**  
HOUSING: THERMOPLASTIC; COLOR: SEE CHART  
END CAP: THERMOPLASTIC; COLOR: BLACK  
SEALS: SILICONE RUBBER; COLOR: RED (FRONT SEAL), GREEN(REAR SEAL)
- MODIFICATIONS:** END CAP, REDUCED DIAMETER SEAL.
- SPECIFICATIONS:**
  - CURRENT RATING: SIZE 16, 13 AMPS; SIZE 12, 25 AMPS.
  - OPERATING TEMPERATURE: -55°C TO +125°C
  - DIELECTRIC WITHSTANDING VOLTAGE: LESS THAN 2 MILLIAMPS CURRENT LEAKAGE @ 1500 VOLTS AC.
  - INSULATION RESISTANCE: 1000 MEGOHMS MIN @ 25°C.
  - MOISTURE RESISTANCE: IP68(1M OF WATER FOR A PERIOD OF 24 HOURS , MATED CONDITION) IP69K(MATED CONDITION)
  - MATING CYCLE DURABILITY: 100 CYCLES
  - RoHS COMPLIANT
- MATING PART:** AT16-15PX-\* RECEPTACLES  
( X = A,B,C,D,E KEYS; \* = MODIFICATIONS AND COLORS )
- ALL DIMENSIONS ARE FOR REFERENCE USE ONLY.**

TITLE: 15 POSITION PLUG, SOCKET,AT SERIES  
DWG NO: AT16-15SX-XXXX  
REV: A1  
SH: 1  
OF: 3

SEE PIN CHART		REF: DT16-15SA-K003, DT16-15SB-K003, DT16-15SC-K003, DT16-15SD-K003, DT16-15SE-K003	
PART NUMBER		DESCRIPTION	
QUANTITY	MATERIALS LIST		
UNLESS OTHERWISE SPECIFIED 1) All dimensions are in metric(mm). 2) Tolerances are as follows: 1 PL DEC ±0.30 2 PL DEC ±0.15 3 PL DEC ±0.08 3) Note reference =	SIGNATURES		DATE
	DRAWN: LOUIE YN		27/JUL/2021
CHECKED: ORION LI		28/JUL/2021	
ENGINEER:			
APPROVAL: TOMMY XIE		28/JUL/2021	
MATERIAL SPECIFICATIONS:		CUSTOMER:	
PROCESS SPECIFICATIONS:		THIS DRAWING IS SUPPLIED FOR INFORMATION ONLY. DESIGN FEATURES, SPECIFICATIONS AND PERFORMANCE DATA SHOWN HEREON ARE THE PROPERTY OF THE AMPHENOL CORPORATION. NO RIGHTS OF REPRODUCTION ARE IMPLIED. ALL DIMENSIONS ARE SUBJECT TO NORMAL MANUFACTURING VARIATIONS.	
NEXT ASSY:		SCALE: NONE	
SIZE: B C-		FSCM NO. DWG NO. AT16-15SX-XXXX	
REVISION: A1		SHEET 1 OF 3	

**SINE Systems Corporation**  
A Subsidiary of Amphenol Corporation  
44724 Morley Drive  
Clinton Township, MI 48036

REVISIONS					
REV	ECO	DESCRIPTION	DATE	BY	APPR
A1	-	RELEASE NUMBER	27/JUL/2021	LOUIE	TOMMY

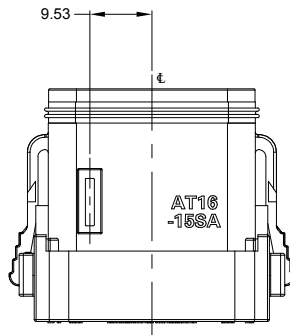

KEY-A CONFIGURATION	
PART NUMBER	COLOR OF HOUSING
AT16-15SA-K003	BLACK
AT16-15SA-EK02	GRAY

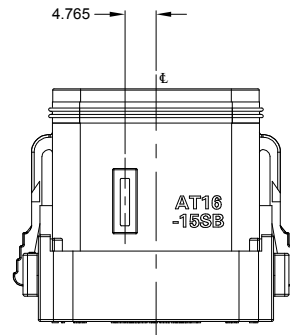

KEY-B CONFIGURATION	
PART NUMBER	COLOR OF HOUSING
AT16-15SB-K003	BLACK

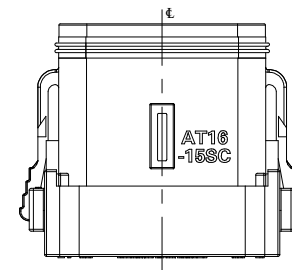

KEY-C CONFIGURATION	
PART NUMBER	COLOR OF HOUSING
AT16-15SC-K003	BLACK
AT16-15SC-EK02	GRAY

TITLE: 15 POSITION PLUG, SOCKET, AT SERIES  
 DWG NO: AT16-15SX-XXXX  
 REV: A1  
 SH: 2  
 OF: 3

SEE PN CHART		DESCRIPTION		ITEM
QUANTITY	PART NUMBER			
<b>MATERIALS LIST</b>				
<b>UNLESS OTHERWISE SPECIFIED</b> 1) All dimensions are in metric(mm). 2) Tolerances are as follows: 1 PL DEC ±0.30 Fractions ±1/64 2 PL DEC ±0.15 Angles ±1° 3 PL DEC ±0.08 3) Note reference =		<b>SIGNATURES</b> DRAWN: LOUIE YIN 27/JUL/2021 CHECKED: ORON LI 28/JUL/2021 ENGINEER: APPROVAL: TOMMY XIE 28/JUL/2021 CUSTOMER:		<b>SINE Systems Corporation</b> A Subsidiary of Amphenol Corporation 44724 Morley Drive Clinton Township, MI 48036
MATERIAL SPECIFICATIONS:  PROCESS SPECIFICATIONS:  NEXT ASSY:		THIS DRAWING IS SUPPLIED FOR INFORMATION ONLY. DESIGN FEATURES, SPECIFICATIONS AND PERFORMANCE DATA SHOWN HEREON ARE THE PROPERTY OF THE AMPHENOL CORPORATION. NO RIGHTS OF REPRODUCTION ARE IMPLIED. ALL DIMENSIONS ARE SUBJECT TO NORMAL MANUFACTURING VARIATIONS.		
		<b>SIZE</b> B C- <b>AT16-15SX-XXXX</b> <b>REVISION</b> A1 SCALE: NONE SHEET 2 OF 3		

REVISIONS					
REV	ECO	DESCRIPTION	DATE	BY	APPR
A1	-	RELEASE NUMBER	27/JUL/2021	LOUIE	TOMMY

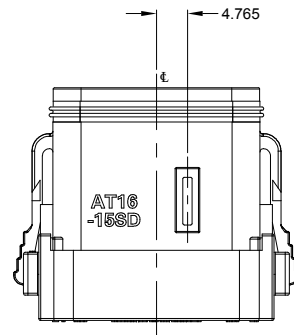

KEY-D CONFIGURATION	
PART NUMBER	COLOR OF HOUSING
AT16-15SD-K003	BLACK
AT16-15SD-EK02	GRAY

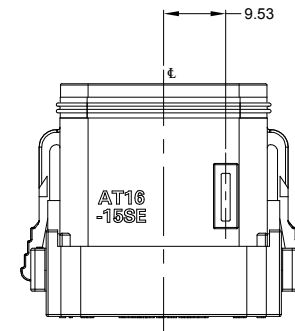

KEY-E CONFIGURATION	
PART NUMBER	COLOR OF HOUSING
AT16-15SE-K003	BLACK
AT16-15SE-EK02	GRAY

TITLE: 15 POSITION PLUG, SOCKET, AT SERIES  
 DWG NO: AT16-15SX-XXXX  
 REV: A1  
 SH: 3  
 OF: 3

SEE PIN CHART		PART NUMBER		DESCRIPTION		ITEM
QUANTITY		<b>MATERIALS LIST</b>				
<b>UNLESS OTHERWISE SPECIFIED</b> 1) All dimensions are in metric (mm). 2) Tolerances are as follows: 1 PL DEC ±0.30 2 PL DEC ±0.15 3 PL DEC ±0.08 3) Note reference =		<b>SIGNATURES</b> DRAWN: LOUIE YIN CHECKED: ORION LI ENGINEER: APPROVAL: TOMMY XIE		<b>DATE</b> 27/JUL/2021 28/JUL/2021 28/JUL/2021		<b>SINE Systems Corporation</b> A Subsidiary of Amphenol Corporation 44724 Morley Drive Clinton Township, MI 48036
MATERIAL SPECIFICATIONS:		CUSTOMER:		15 POSITION PLUG, SOCKET, AT SERIES		
PROCESS SPECIFICATIONS:		THIS DRAWING IS SUPPLIED FOR INFORMATION ONLY. DESIGN FEATURES, SPECIFICATIONS AND PERFORMANCE DATA SHOWN HEREON ARE THE PROPERTY OF THE AMPHENOL CORPORATION. NO RIGHTS OF REPRODUCTION ARE IMPLIED. ALL DIMENSIONS ARE SUBJECT TO NORMAL MANUFACTURING VARIATIONS.		<b>SIZE</b> FSCM NO. DWG NO. <b>B C-</b> AT16-15SX-XXXX		<b>REVISION</b> <b>A1</b>
NEXT ASSY:		SCALE: NONE		SHEET 3 OF 3		

# A Series™ - Contact Size 12 Options (Works with: AHD-6, ATP, ATHD, DuraMate and PanelMate Series)

Machined Contacts, Sockets & Pins				
Part Number	Description	Size	AWG	Type
*AT60-204-12141-10	Male Contact - Pin, Nickel-plated	12	10-12	Machined
*AT62-203-12141-10	Female Contact - Socket, Nickel-plated	12	10-12	Machined
AT60-220-1231	Male Contact - Pin, Gold-plated	12	12-14	Machined
AT62-210-1231	Female Contact - Socket, Gold-plated	12	12-14	Machined
AT60-204-12141	Male Contact - Pin, Nickel-plated	12	12-14	Machined
AT62-203-12141	Female Contact - Socket, Nickel-plated	12	12-14	Machined

\*Works with ATP Series only

DiagnosticGrade™ Machined Contacts, Sockets & Pins				
• Smaller AWG for Diagnostic Applications • Gold-plated • Increased Mating Cycles • Cost-effective				
Part Number	Description	Size	AWG	Type
65-54749	Male Contact - DiagnosticGrade™, Pin, Gold-plated	12	20	Machined
AT62-210-1231-1820	Female Contact - DiagnosticGrade™, Socket, Gold-plated	12	20	Machined

Tooling - Machined Contacts	
Part Number	Description
AUTK-12	Hand Crimp Tool, Size 12
AUTK-100	Universal Heavy Duty Contact Crimping Tool Kit, Size 12/16/20
CA-5D12	Universal Hand Crimp Tool, Size 12/16/20
CA-5E12	Pneumatic Crimp Tool, Size 12/16/20
M300-25A	Hand Crimp Tool used with Crimp Locator MFX-3966, Size 12, 10AWG
MFX-3966	Contact Locator used with Hand Crimp Tool M300-25A, Size 12, 10AWG

Contact Removal Tools (For both Machined or Stamped & Formed Contacts)	
Part Number	Description
ATRT-100	Contact and Wedgelock Extraction Tool
AT11-337-1205	Contact Removal Tool, Plastic, Size 12

Sealing Plugs (For both Machined or Stamped & Formed Contacts)	
Part Number	Description
A114017	Sealing Plug, Size 12, White

Stamped & Formed Contacts, Sockets & Pins				
Part Number	Description	Size	AWG	Type
AT60-12-0244	Male Contact - Pin, Gold-plated	12	10-12	Stamped & Formed
AT62-12-0244	Female Contact - Socket, Gold-plated	12	10-12	Stamped & Formed
AT60-12-0222	Male Contact - Pin, Nickel-plated	12	10-12	Stamped & Formed
AT62-12-0222	Female Contact - Socket, Nickel-plated	12	10-12	Stamped & Formed
AT60-12-0144	Male Contact - Pin, Gold-plated	12	12-14	Stamped & Formed
AT62-12-0144	Female Contact - Socket, Gold-plated	12	12-14	Stamped & Formed
AT60-12-0166	Male Contact - Pin, Nickel-plated	12	12-14	Stamped & Formed
AT62-12-0166	Female Contact - Socket, Nickel-plated	12	12-14	Stamped & Formed

Tooling - Stamped & Formed Contacts	
Part Number	Description
MFX-3973	Crimp Die - Size 12
MFX-3985	Crimp Die - Ssize 12, 10-12AWG -02XX Series
ATT-12-00	Hand Crimp Tool - Size 12, 12AWG
ATT-12-01	Hand Crimp Tool - Size 12, 10AWG

# A Series™ - Contact Size 16 Options (Works with: AT, ATV, AHD-9, ARC, DuraMate and PanelMate Series)

Machined Contacts, Sockets & Pins				
Part Number	Description	Size	AWG	Type
AT60-215-1631	Male Contact - Pin, Gold-plated	16	14	Machined
AT62-209-1631	Female Contact - Socket, Gold-plated	16	14	Machined
AT60-215-16141	Male Contact - Pin, Nickel-plated	16	14	Machined
AT62-209-16141	Female Contact - Socket, Nickel-plated	16	14	Machined
AT60-202-1631	Male Contact - Pin, Gold-plated	16	16-20	Machined
AT62-201-1631	Female Contact - Socket, Gold-plated	16	16-20	Machined
AT60-202-16141	Male Contact - Pin, Nickel-plated	16	16-20	Machined
AT62-201-16141	Female Contact - Socket, Nickel-plated	16	16-20	Machined
AT60-202-1631-22	Male Contact - Pin, Gold-plated	16	22-24	Machined
AT62-201-1631-22	Female Contact - Socket, Gold-plated	16	22-24	Machined
AT60-202-16141-22	Male Contact - Pin, Nickel-plated	16	22-24	Machined
AT62-201-16141-22	Female Contact - Socket, Nickel-plated	16	22-24	Machined

Tooling - Machined Contacts	
Part Number	Description
AUTK-16	Hand Crimp Tool, Size 16
AUTK-100	Universal Heavy Duty Contact Crimping Tool Kit, Size 12/16/20
CA-5D12	Universal Hand Crimp Tool, Size 12/16/20
CA-5E12	Pneumatic Crimp Tool, Size 12/16/20

Contact Removal Tools (For both Machined or Stamped & Formed Contacts)	
Part Number	Description
ATRT-100	Contact and Wedgelock Extraction Tool
AT11-310-1605	Contact Removal Tool, Plastic, Size 16

Sealing Plugs (For both Machined or Stamped & Formed Contacts)	
Part Number	Description
A114017	Sealing Plug, Size 16, White
A114017-SR	Sealing Plug, Size 16, SR01 Series, Black
AT13-217-1605	Locking Sealing Plug, Size 16, Grey
AT13-217-1605-SR	Locking Sealing Plug, Size 16, SR01 Series, Red

Stamped & Formed Contacts, Sockets & Pins				
Part Number	Description	Size	AWG	Type
AT60-14-0122	Male Contact - Pin, Nickel-plated	16	14-18	Stamped & Formed
AT62-14-0122	Female Contact - Socket, Nickel-plated	16	14-18	Stamped & Formed
AT60-14-0144	Male Contact - Pin, Gold-plated	16	14-18	Stamped & Formed
AT62-14-0144	Female Contact - Socket, Gold-plated	16	14-18	Stamped & Formed
AT60-16-0122	Male Contact - Pin, Nickel-plated	16	16-18	Stamped & Formed
AT62-16-0122	Female Contact - Socket, Nickel-plated	16	16-18	Stamped & Formed
AT60-16-0144	Male Contact - Pin, Gold-plated	16	16-18	Stamped & Formed
AT62-16-0144	Female Contact - Socket, Gold-plated	16	16-18	Stamped & Formed
AT60-16-0622	Male Contact - Pin, Nickel-plated	16	16-20	Stamped & Formed
AT62-16-0622	Female Contact - Socket, Nickel-plated	16	16-20	Stamped & Formed
AT60-16-0644	Male Contact - Pin, Gold-plated	16	16-20	Stamped & Formed
AT62-16-0644	Female Contact - Socket, Gold-plated	16	16-20	Stamped & Formed
AT60-16-0677	Male Contact - Pin, Tin-plated	16	16-20	Stamped & Formed
AT62-16-0677	Female Contact - Socket, Tin-plated	16	16-20	Stamped & Formed
AT60-16-0822	Male Contact - Pin, Nickel-plated	16	20-22	Stamped & Formed
AT62-16-0822	Female Contact - Socket, Nickel-plated	16	20-22	Stamped & Formed
AT60-16-0844	Male Contact - Pin, Gold-plated	16	20-22	Stamped & Formed
AT62-16-0844	Female Contact - Socket, Gold-plated	16	20-22	Stamped & Formed

Tooling - Stamped & Formed Contacts	
MFX-3950	Crimp Die - Size 16, 18-20AWG
MFX-3953	Crimp Die - Size 16, 16-18AWG
MFX-3975	Crimp Die - Size 16, 14-16AWG
MFX-3990	Crimp Die - Size 16, 20-22AWG
ATT-16-00	Hand Crimp Tool - Size 16, 14-16AWG
ATT-16-01	Hand Crimp Tool - Size 16, 18-20AWG
ATT-1612-03	Hand Crimp Tool - Size 16, 20-22AWG