

2CCT RECEPTACLE CONNECTOR

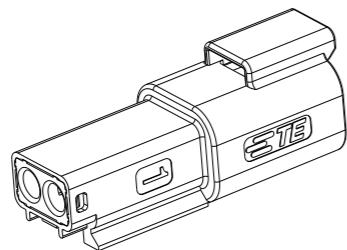

DATE CODE: X XX XX  
 X- DAY: 1- 7  
 XX- WEEK: 01 - 52  
 XX- YEAR: 00 - 99

#- MACHINE NO. 1

EXAMPLE: 11315 = DAY 1, WEEK 13, YEAR 15  
 i.e. 23rd OF MARCH 2015

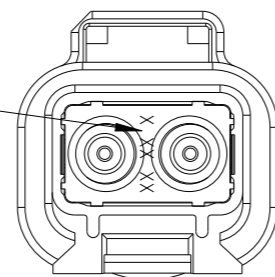

DETAIL B  
 SCALE 2:1

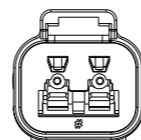
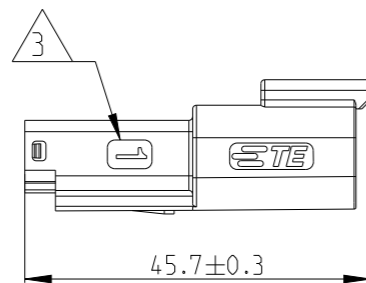
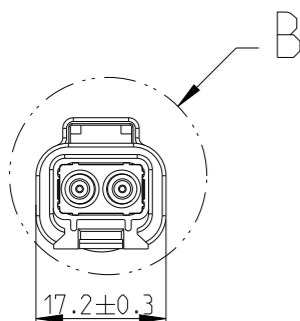

1. THIS RECEPT MATES WITH PLUG ASSEMBLY PN X-2600023-X, WEDGE LOCKPN W2PX.

2. MATERIAL  
 RECEPT HOUSING: NYLON GF30  
 BACK SEAL: SILICONE RUBBER  
 BACK COVER: NYLON GF30, BLACK  
 HEATSHRINK HOUSING: NYLON GF30, BLACK

**3** CIRCUIT IDENTIFICATION

4. JACKET RANGE LARGE = 2.23mm - 3.68mm (SEAL COLOUR: GREEN)  
 JACKET RANGE SMALL = 1.20mm - 3.05mm (SEAL COLOUR: BURNT ORANGE)

DIMENSIONS:  
 mm

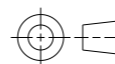

TOLERANCES UNLESS OTHERWISE SPECIFIED:

0 PLC ±  
 1 PLC ±  
 2 PLC ±  
 3 PLC ±  
 4 PLC ±  
 ANGLES ±

MATERIAL

FINISH

-

-

THIS DRAWING IS A CONTROLLED DOCUMENT.

DWN J.SHANG 16 JUN 2020  
 CHK E.JIANG 16 JUN 2020  
 APVD L.YIN 16 JUN 2020

PRODUCT SPEC  
 108-160026

APPLICATION SPEC  
 114-160017

WEIGHT -

CUSTOMER DRAWING

REVISIONS

| P | LTR | DESCRIPTION     | DATE        | DWN | APVD |
|---|-----|-----------------|-------------|-----|------|
|   | A   | INITIAL RELEASE | 16 JUN 2020 | J.S | I.Y  |
|   | A1  | ECR-20-010349   | 24 JUL 2020 | J.G | I.Y  |
|   | A2  | ECN-21-113425   | 17 AUG 2021 | J.G | Z.Z  |

2CCT RECEPTACLE CONNECTOR WITH HEATSHRINK HOUSING ULTRASONICALLY WELDED IN PLACE

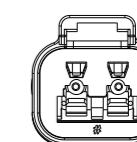
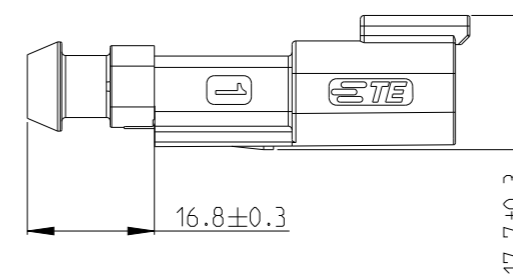
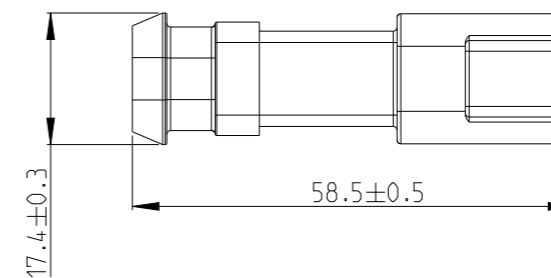
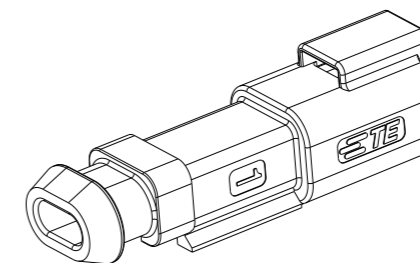

NAME  
 2CCT DT-XT RECEPTACLE CONNECTOR

SIZE CAGE CODE DRAWING NO RESTRICTED TO

A3 00779 C-2600022

SCALE 1:1 SHEET 1 OF 2 REV A2

