

2203859-4 ✓ ACTIVE

DEUTSCH | AMPSEAL 16

TE Internal #: 2203859-4

Housing for Female Terminals, Wire-to-Wire, 24 Position, 7.5 mm Centerline, Sealable, Black, Wire & Cable, Power & Signal, AMPSEAL 16

[View on TE.com >](#)



Connectors > Automotive Connectors > Automotive Housings



Connector System: **Wire-to-Wire**

Number of Positions: **24**

Connector & Housing Type: **Housing for Female Terminals**

Centerline (Pitch): **7.5 mm**

Sealable: **Yes**

## Features

### Product Type Features

Mixed & Hybrid Connector	Yes
Connector Shape	Rectangular
Connector System	Wire-to-Wire
Connector & Housing Type	Housing for Female Terminals
Sealable	Yes
Connector & Contact Terminates To	Wire & Cable
Primary Locking Feature	Integrated in Housing

### Configuration Features

Blank Cavity Position	0
Number of Positions	24
Number of Rows	4

### Electrical Characteristics

Nominal Voltage Architecture	24 V
------------------------------	------

### Body Features



Cable Exit Angle	180°
Primary Product Color	Black
Connector & Keying Code	D

#### Contact Features

Contact Size	Size 12, Size 16
Contact Type	Socket
Mating Pin Diameter	2.37 mm
Contact Current Rating (Max)	25 A

#### Mechanical Attachment

Terminal Position Assurance	Yes
Strain Relief	Add By Accessory
Mating Alignment Type	Keyed
Mating Alignment	With
Connector Mounting Type	Cable Mount (Free-Hanging)

#### Housing Features

Housing Material	PBT
Centerline (Pitch)	7.5 mm

#### Dimensions

Connector Height	43.5 mm
Product Width	48.09 mm
Product Length	72.7 mm
Row-to-Row Spacing	4.7 mm

#### Usage Conditions

Operating Temperature (Max)	125 °C
Operating Temperature Range	-40 – 125 °C

#### Operation/Application

Circuit Application	Power & Signal
---------------------	----------------

#### Industry Standards

Degree of Protection	IP6K9K
UL Flammability Rating	UL 94HB

#### Packaging Features

--	--



Packaging Quantity	80
Packaging Method	Box & Tray

### Other

Serviceable	No
Connector Position Assurance Capable	Yes

## Product Compliance

[For compliance documentation, visit the product page on TE.com>](#)

EU RoHS Directive 2011/65/EU	Compliant
EU ELV Directive 2000/53/EC	Compliant
China RoHS 2 Directive MIIT Order No 32, 2016	No Restricted Materials Above Threshold
EU REACH Regulation (EC) No. 1907/2006	<p>Current ECHA Candidate List: JUNE 2023 (235)  Candidate List Declared Against: JAN 2023 (233)  SVHC &gt; Threshold:  Octamethylcyclotetrasiloxane (D4) (.5% in Component part)  Decamethylcyclopentasiloxane (D5) (.5% in Component part)  Dodecamethylcyclohexasiloxane (D6) (.5% in Component part)</p> <p><b>Article Safe Usage Statements:</b>  Wash thoroughly after handling. Recycle if possible and dispose of the article by following all applicable governmental regulations relevant to your geographic location.</p>
Halogen Content	Not Yet Reviewed for halogen content
Solder Process Capability	Not reviewed for solder process capability

### Product Compliance Disclaimer

This information is provided based on reasonable inquiry of our suppliers and represents our current actual knowledge based on the information they provided. This information is subject to change. The part numbers that TE has identified as EU RoHS compliant have a maximum concentration of 0.1% by weight in homogenous materials for lead, hexavalent chromium, mercury, PBB, PBDE, DBP, BBP, DEHP, DIBP, and 0.01% for cadmium, or qualify for an exemption to these limits as defined in the Annexes of Directive 2011/65/EU (RoHS2). Finished electrical and electronic equipment products will be CE marked as required by Directive 2011/65/EU. Components may not be CE marked. Additionally, the part numbers that TE has identified as EU ELV compliant have a maximum concentration of 0.1% by weight in homogenous materials for lead, hexavalent chromium, and mercury, and 0.01% for cadmium, or qualify for an exemption to these limits as defined in the Annexes of Directive 2000/53/EC (ELV). Regarding the REACH Regulation, the information TE provides on SVHC in articles for this part number is based on the latest European Chemicals Agency (ECHA) 'Guidance on requirements for substances in articles' posted at this URL: <https://echa.europa.eu/guidance-documents/guidance-on-reach>

## Compatible Parts



## Also in the Series | AMPSEAL 16

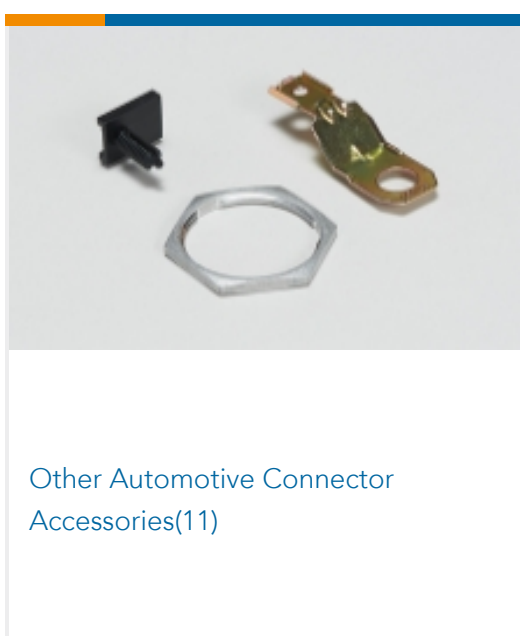
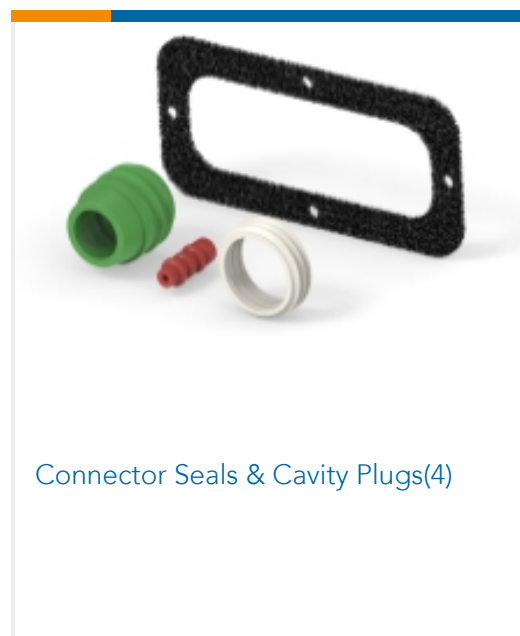
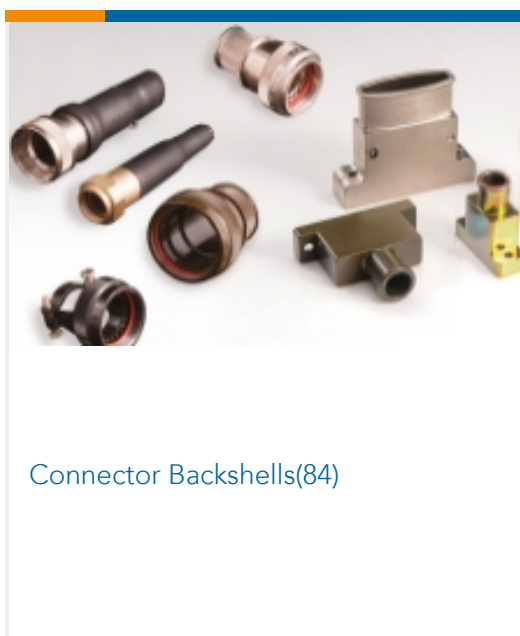
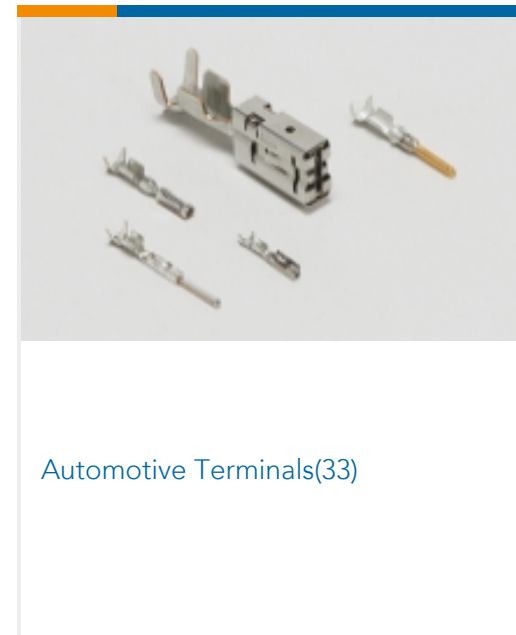
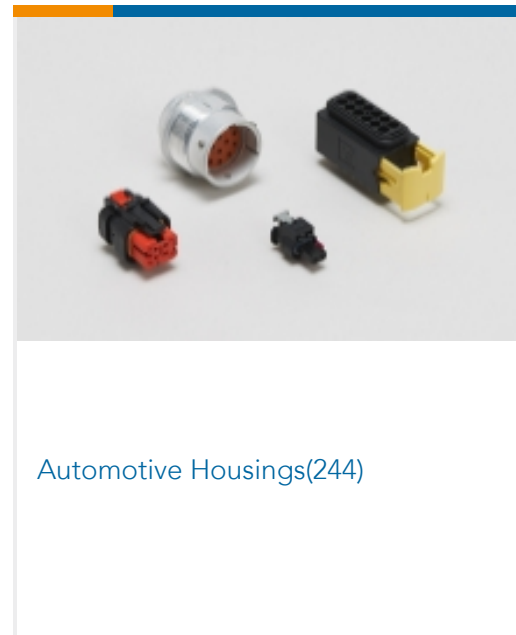
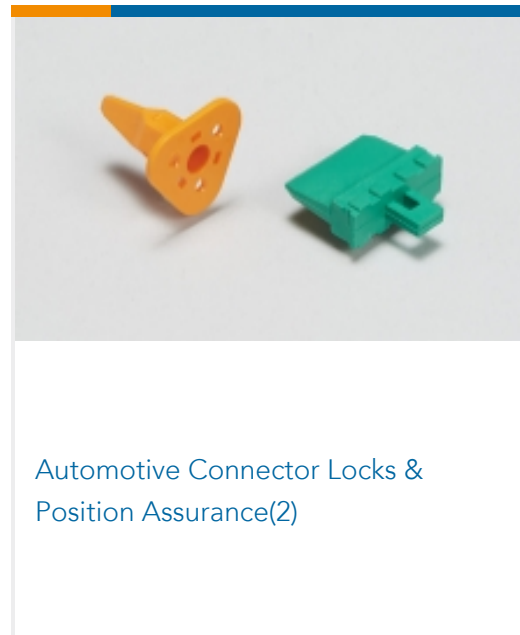
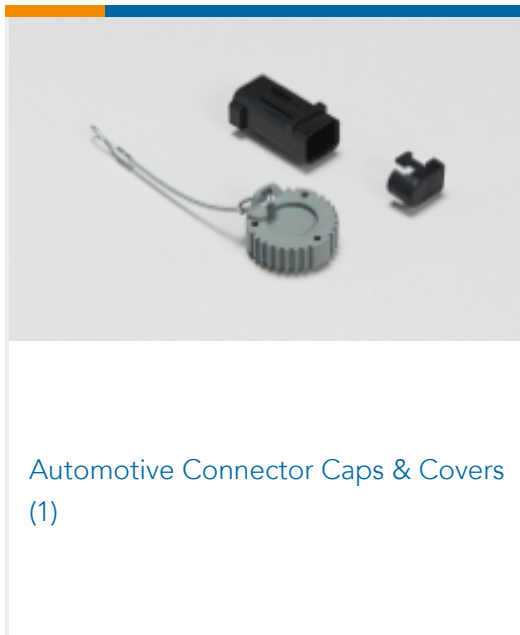

## Customers Also Bought

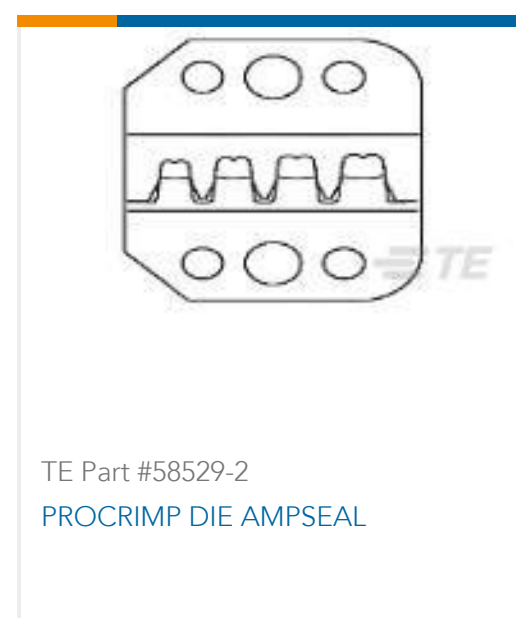





## Documents

### Product Drawings

[24POS, HYBRID, SOC HSG ASSY, SLD, COD D](#)

English

### CAD Files

[3D PDF](#)

3D

Customer View Model

[ENG\\_CVM\\_CVM\\_2203859-4\\_2.2d\\_dxf.zip](#)

English

Customer View Model

[ENG\\_CVM\\_CVM\\_2203859-4\\_2.3d\\_igs.zip](#)

English

Customer View Model

[ENG\\_CVM\\_CVM\\_2203859-4\\_2.3d\\_stp.zip](#)

English

By downloading the CAD file I accept and agree to the [Terms and Conditions](#) of use.

### Product Specifications

[Application Specification](#)

English