

NOTES: UNLESS OTHERWISE SPECIFIED

- MATERIAL:
HOUSING: NATURAL ULTEM
SEAL: SILICONE RUBBER
- MODIFICATIONS: LIGHT EMITTING DIODE (GREEN), REVERSE VOLTAGE PROTECTION CIRCUIT (RVPC).
- CONNECTOR SPECIFICATIONS:
3.1 CURRENT RATING: 13 AMPS
3.2 DIELECTRIC WITHSTANDING VOLTAGE: LESS THAN 2 MILLIAMPS CURRENT LEAKAGE @ 1500 VOLTS AC.
3.3 INSULATION RESISTANCE: 1000 MEGOHMS MIN @ 25°C.
3.4 MOISTURE RESISTANCE:
IP68 (1M OF WATER FOR A PERIOD OF 24 HOURS, MATED CONDITION)
IP69K (MATED CONDITION)
3.5 MATING CYCLE DURABILITY: 100 CYCLES
3.6 ROHS COMPLIANT
- LED SPECIFICATIONS:
4.1 FORWARD CURRENT: 30 MILLIAMPS TYPICAL;
100 MILLIAMPS MAXIMUM
4.2 REVERSE CURRENT: 50 MICROAMPS MAXIMUM
4.3 POWER DISSIPATION: 120 MILLIWATTS MAXIMUM
4.4 FORWARD VOLTAGE: 4 VOLTS MAXIMUM
4.5 REVERSE VOLTAGE: 5 VOLTS MAXIMUM
- RESISTOR SPECIFICATIONS:
5.1 RESISTANCE VALUE (R1): 330 OHMS;
5.2 RESISTANCE VALUE (R2): 0 OHMS;
5.3 POWER RATING: 1/8 WATTS
5.4 MAX.WORKING VOLTAGE: 150 VOLTS
- SUPPRESSOR DIODE SPECIFICATIONS:
6.1 STAND-OFF VOLTAGE: 14 VOLTS;
6.2 MAX. FORWARD CURRENT: 5µA @ 14V
6.3 PEAK PULSE POWER DISSIPATION: 400 WATTS
- MATING PART: AT04-2P* RECEPTACLE
(* = MODIFICATIONS AND COLORS)
- ALL DIMENSIONS ARE FOR REFERENCE USE ONLY.

⑨ CONTACT SIZE AND REAR SEAL WIRE RANGE:

REDUCED DIAMETER SEAL:

CONTACT SIZE	MIN. INSUL O.D.	MAX. INSUL O.D.	TYPICAL WIRE RANGE
16	1.35 mm (.053 in)	3.05 mm (.120 in)	14 - 20 AWG (2.0-0.5mm ²)

STANDARD SEAL:

CONTACT SIZE	MIN. INSUL O.D.	MAX. INSUL O.D.	TYPICAL WIRE RANGE
16	2.24 mm (.088 in)	3.68 mm (.145 in)	14 - 20 AWG (2.0-0.5mm ²)

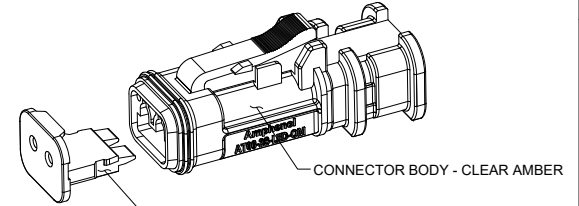
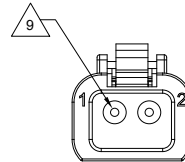
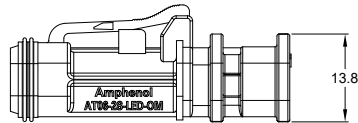
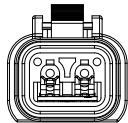
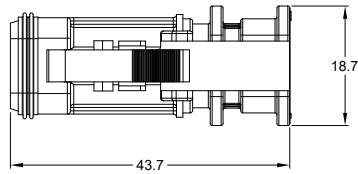

REQUIRES BLACK CONTACT RETENTION WEDGE: AW2S-LED (SOLD SEPARATELY)

LASER ENGRAVE POLARITY, CONTACT NUMBER, VOLTAGE, SEAL TYPE, SPECIAL CIRCUIT TYPE (RVPC), AND LED COLOR CODE AS SHOWN IN THIS AREA.

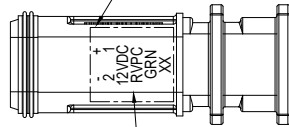

SEE PART NUMBER CHART BELOW.
XX = SEAL CODE. RD IF REDUCED DIA.,
BLANK IF STANDARD SEAL.

COMPONENT TYPES:

- R2 RESISTOR: TYPE 0805, R0Ω, 1/8W
- SMD LED: KPA-1606ZGC-G
- R1 RESISTOR: TYPE 0805, R330Ω, 1/8W
- SMD T.V.S. DIODE: 400W, 14V, P4SMAJ14CA

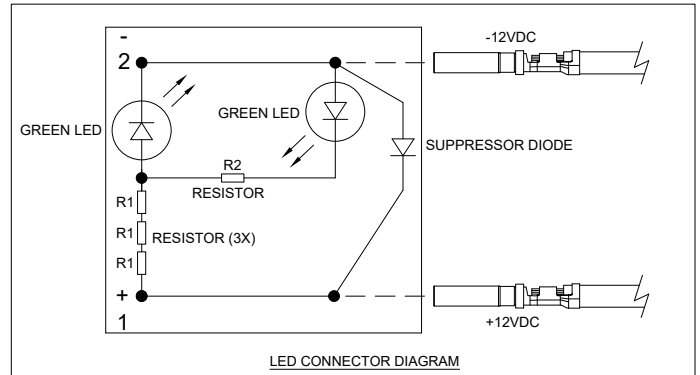

LED CONNECTOR DIAGRAM

QUANTITY	SEE PART NUMBER CHART	DESCRIPTION	ITEM
	PART NUMBER		

MATERIALS LIST		SIGNATURES		DATE
UNLESS OTHERWISE SPECIFIED: 1) All dimensions are in metric (mm). 2) Tolerances are as follows: 1 PL DEC ±0.30 2 PL DEC ±0.15 3 PL DEC ±0.08 3) Note reference = ⑨ Fractions ±1/64 Angles ±1°		DRAWN: MILO DONG	DATE: 20DEC21	
MATERIAL SPECIFICATIONS:		CHECKED: SULLEN ZHANG	DATE: 20DEC21	
PROCESS SPECIFICATIONS:		ENGINEER:	APPROVAL: TOMMY XIE	DATE: 21DEC21
NEXT ASSY:		CUSTOMER:		
THIS DRAWING IS SUPPLIED FOR INFORMATION ONLY. DESIGN FEATURES, SPECIFICATIONS AND PERFORMANCE DATA SHOWN HEREON ARE THE PROPERTY OF THE AMPHENOL CORPORATION. NO RIGHTS OF REPRODUCTION ARE IMPLIED. ALL DIMENSIONS ARE SUBJECT TO NORMAL MANUFACTURING VARIATIONS.				
AT SERIES, 2-WAY, PLUG, LED, 12V, AMBER BODY, RVPC CIRCUIT, OVERMOLD		SIZE: B C-	TYPE: AT06-2S-LED12VX1-OM	REVISION: A3
SCALE: NONE		SHEET 1 OF 1		

PART NUMBER CHART	
SEAL	PART NUMBER
STANDARD	AT06-2S-LED12V01-OM
REDUCED DIAMETER	AT06-2S-LED12VR1-OM

TITLE: AT SERIES, 2-WAY, PLUG, LED, 12V, AMBER BODY, RVPC CIRCUIT, OVERMOLD
DWG NO: AT06-2S-LED12VX1-OM
REV: A3
SH: 1
OF: 1

A Series™ - Contact Size 16 Options (Works with: AT, ATV, AHD-9, ARC, DuraMate and PanelMate Series)

Machined Contacts, Sockets & Pins				
Part Number	Description	Size	AWG	Type
AT60-215-1631	Male Contact - Pin, Gold-plated	16	14	Machined
AT62-209-1631	Female Contact - Socket, Gold-plated	16	14	Machined
AT60-215-16141	Male Contact - Pin, Nickel-plated	16	14	Machined
AT62-209-16141	Female Contact - Socket, Nickel-plated	16	14	Machined
AT60-202-1631	Male Contact - Pin, Gold-plated	16	16-20	Machined
AT62-201-1631	Female Contact - Socket, Gold-plated	16	16-20	Machined
AT60-202-16141	Male Contact - Pin, Nickel-plated	16	16-20	Machined
AT62-201-16141	Female Contact - Socket, Nickel-plated	16	16-20	Machined
AT60-202-1631-22	Male Contact - Pin, Gold-plated	16	22-24	Machined
AT62-201-1631-22	Female Contact - Socket, Gold-plated	16	22-24	Machined
AT60-202-16141-22	Male Contact - Pin, Nickel-plated	16	22-24	Machined
AT62-201-16141-22	Female Contact - Socket, Nickel-plated	16	22-24	Machined

Tooling - Machined Contacts	
Part Number	Description
AUTK-16	Hand Crimp Tool, Size 16
AUTK-100	Universal Heavy Duty Contact Crimping Tool Kit, Size 12/16/20
CA-5D12	Universal Hand Crimp Tool, Size 12/16/20
CA-5E12	Pneumatic Crimp Tool, Size 12/16/20

Contact Removal Tools (For both Machined or Stamped & Formed Contacts)	
Part Number	Description
ATRT-100	Contact and Wedgelock Extraction Tool
AT11-310-1605	Contact Removal Tool, Plastic, Size 16

Sealing Plugs (For both Machined or Stamped & Formed Contacts)	
Part Number	Description
A114017	Sealing Plug, Size 16, White
A114017-SR	Sealing Plug, Size 16, SR01 Series, Black
AT13-217-1605	Locking Sealing Plug, Size 16, Grey
AT13-217-1605-SR	Locking Sealing Plug, Size 16, SR01 Series, Red

Stamped & Formed Contacts, Sockets & Pins				
Part Number	Description	Size	AWG	Type
AT60-14-0122	Male Contact - Pin, Nickel-plated	16	14-18	Stamped & Formed
AT62-14-0122	Female Contact - Socket, Nickel-plated	16	14-18	Stamped & Formed
AT60-14-0144	Male Contact - Pin, Gold-plated	16	14-18	Stamped & Formed
AT62-14-0144	Female Contact - Socket, Gold-plated	16	14-18	Stamped & Formed
AT60-16-0122	Male Contact - Pin, Nickel-plated	16	16-18	Stamped & Formed
AT62-16-0122	Female Contact - Socket, Nickel-plated	16	16-18	Stamped & Formed
AT60-16-0144	Male Contact - Pin, Gold-plated	16	16-18	Stamped & Formed
AT62-16-0144	Female Contact - Socket, Gold-plated	16	16-18	Stamped & Formed
AT60-16-0622	Male Contact - Pin, Nickel-plated	16	16-20	Stamped & Formed
AT62-16-0622	Female Contact - Socket, Nickel-plated	16	16-20	Stamped & Formed
AT60-16-0644	Male Contact - Pin, Gold-plated	16	16-20	Stamped & Formed
AT62-16-0644	Female Contact - Socket, Gold-plated	16	16-20	Stamped & Formed
AT60-16-0677	Male Contact - Pin, Tin-plated	16	16-20	Stamped & Formed
AT62-16-0677	Female Contact - Socket, Tin-plated	16	16-20	Stamped & Formed
AT60-16-0822	Male Contact - Pin, Nickel-plated	16	20-22	Stamped & Formed
AT62-16-0822	Female Contact - Socket, Nickel-plated	16	20-22	Stamped & Formed
AT60-16-0844	Male Contact - Pin, Gold-plated	16	20-22	Stamped & Formed
AT62-16-0844	Female Contact - Socket, Gold-plated	16	20-22	Stamped & Formed

Tooling - Stamped & Formed Contacts	
MFX-3950	Crimp Die - Size 16, 18-20AWG
MFX-3953	Crimp Die - Size 16, 16-18AWG
MFX-3975	Crimp Die - Size 16, 14-16AWG
MFX-3990	Crimp Die - Size 16, 20-22AWG
ATT-16-00	Hand Crimp Tool - Size 16, 14-16AWG
ATT-16-01	Hand Crimp Tool - Size 16, 18-20AWG
ATT-1612-03	Hand Crimp Tool - Size 16, 20-22AWG