

87499-4 ✓ ACTIVE

AMPMODU | AMPMODU IV/V

TE Internal #: 87499-4

Housing, Receptacle, Wire-to-Board, 2 Position, .1 in [2.54 mm]

Centerline, Crimp, 1 Row, Black, Wire & Cable, Signal, AMPMODU IV/V

[View on TE.com >](#)



Connectors > PCB Connectors > Wire-to-Board Connectors > Wire-to-Board Connector Assemblies & Housings

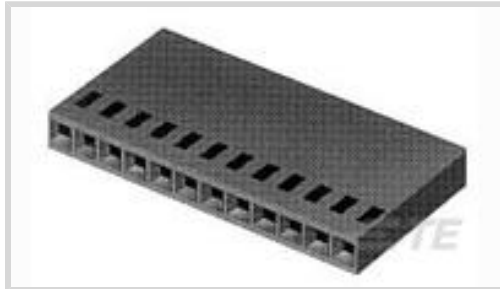

Connector Product Type: **Housing**

Connector & Housing Type: **Receptacle**

Connector System: **Wire-to-Board**

Number of Positions: **2**

Centerline (Pitch): **2.54 mm [.1 in]**

Features

Product Type Features

Connector Product Type	Housing
Connector & Housing Type	Receptacle
Connector System	Wire-to-Board
Connector & Contact Terminates To	Wire & Cable

Configuration Features

Number of Positions	2
Number of Rows	1

Electrical Characteristics

Termination Resistance	12 mΩ
Insulation Resistance	5000 MΩ
Dielectric Withstanding Voltage (Max)	750 V
Operating Voltage	250 VAC

Body Features

Primary Product Color	Black
-----------------------	-------

Contact Features

Contact Layout	Inline
Contact Type	Socket
Contact Base Material	Beryllium Copper



Contact Current Rating (Max)	3 A
------------------------------	-----

Termination Features

Termination Method to Wire & Cable	Crimp
------------------------------------	-------

Mechanical Attachment

Strain Relief	Without
---------------	---------

Mating Retention	Without
------------------	---------

Housing Features

Housing Entry Configuration	Both Ends Closed
-----------------------------	------------------

Housing Material	Thermoplastic
------------------	---------------

Centerline (Pitch)	2.54 mm[.1 in]
--------------------	----------------

Dimensions

Connector Length	5.21 mm[.21 in]
------------------	-----------------

Connector Height	3.56 mm[.14 in]
------------------	-----------------

Row-to-Row Spacing	2.54 mm[.1 in]
--------------------	----------------

Usage Conditions

Operating Temperature Range	-65 – 105 °C[-85 – 221 °F]
-----------------------------	----------------------------

Operation/Application

Circuit Application	Signal
---------------------	--------

Industry Standards

Glow Wire Rating	Standard Part - Not Glow Wire
------------------	-------------------------------

Compatible With Approved Standards Products	CSA LR7189, UL E28476
---------------------------------------------	-----------------------

UL Flammability Rating	UL 94V-0
------------------------	----------

Packaging Features

Packaging Quantity	1
--------------------	---

Packaging Method	Package
------------------	---------

Product Compliance

[For compliance documentation, visit the product page on TE.com>](#)

EU RoHS Directive 2011/65/EU	Compliant
------------------------------	-----------

EU ELV Directive 2000/53/EC	Compliant
-----------------------------	-----------

China RoHS 2 Directive MIIT Order No 32, 2016	No Restricted Materials Above Threshold
-----------------------------------------------	-----------------------------------------



EU REACH Regulation (EC) No. 1907/2006

Current ECHA Candidate List: JUNE 2023 (235)

Candidate List Declared Against: JUNE 2023 (235)

Does not contain REACH SVHC

Halogen Content

BFR/CFR/PVC Free, but Br/Cl >900 ppm in other sources.

Solder Process Capability

Not applicable for solder process capability

Product Compliance Disclaimer

This information is provided based on reasonable inquiry of our suppliers and represents our current actual knowledge based on the information they provided. This information is subject to change. The part numbers that TE has identified as EU RoHS compliant have a maximum concentration of 0.1% by weight in homogenous materials for lead, hexavalent chromium, mercury, PBB, PBDE, DBP, BBP, DEHP, DIBP, and 0.01% for cadmium, or qualify for an exemption to these limits as defined in the Annexes of Directive 2011/65/EU (RoHS2). Finished electrical and electronic equipment products will be CE marked as required by Directive 2011/65/EU. Components may not be CE marked. Additionally, the part numbers that TE has identified as EU ELV compliant have a maximum concentration of 0.1% by weight in homogenous materials for lead, hexavalent chromium, and mercury, and 0.01% for cadmium, or qualify for an exemption to these limits as defined in the Annexes of Directive 2000/53/EC (ELV). Regarding the REACH Regulation, the information TE provides on SVHC in articles for this part number is based on the latest European Chemicals Agency (ECHA) 'Guidance on requirements for substances in articles' posted at this URL: <https://echa.europa.eu/guidance-documents/guidance-on-reach>

Compatible Parts



TE Part # 1-87523-6
MOD IV RECP LP



TE Part # 87666-2
MOD IV RECP PLTD 30 SEL



TE Part # 87756-6
MOD IV RECP PLTD SN



TE Part # 2-87195-4
MOD IV RECP PLTE 15 DPLX



TE Part # 87809-1
MOD V RECP PLTD 30 AU



TE Part # 6-87756-2
MOD IV RECP PLTD 15 DPLX LF





TE Part # 87309-9
MOD V RECP PLTD 30 AU





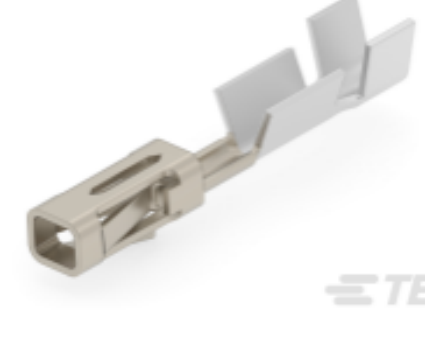



TE Part # 102917-5
MOD IV RECP PLTD 15 SEL

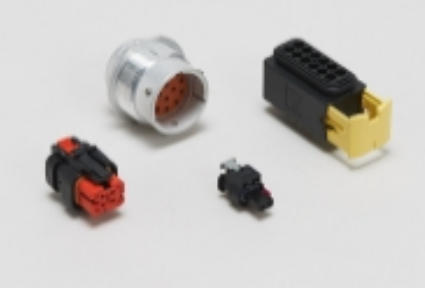
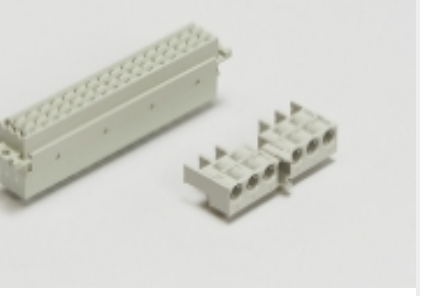

 <p>TE Part # 87523-5 MOD IV RECP PLTD SN</p>	 <p>TE Part # 102548-5 MOD IV RECP PLTD 30 SEL</p>	 <p>TE Part # 87309-8 MOD V RECP PLTD SN</p>	 <p>TE Part # 2-87523-3 MOD IV RECP PLTD 15 DPLX</p>
 <p>TE Part # 5-103171-4 MOD IV RECP PLTD 30 DPLX LF</p>	 <p>TE Part # 85969-8 MOD IV RECP PLTD 30 SEL</p>	 <p>TE Part # 87666-3 MOD IV RECP PLTD SN</p>	 <p>TE Part # 1-102316-4 MOD IV RECP LP</p>
 <p>TE Part # 1-87523-9 MOD IV RECP LP</p>	 <p>TE Part # 5-102920-1 MOD IV RECP PLTD 30 DPLX LF</p>	 <p>TE Part # 103455-1 MOD V RECP PLTD 30 AU</p>	 <p>TE Part # 102316-6 MOD IV RECP PLTD 15 DPLX</p>

Also in the Series | AMPMODU IV/V

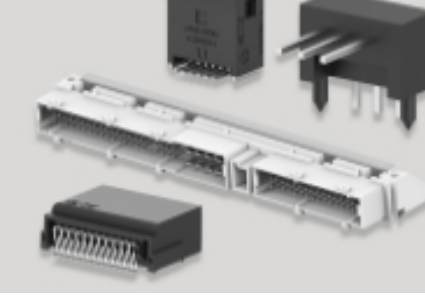
 <p>Automotive Housings(1)</p>	 <p>Backplane Connector Housings(1)</p>	 <p>Connector Caps & Covers(18)</p>	 <p>Connector Contacts(322)</p>
 <p>Connector Hardware(13)</p>	 <p>Connector Strain Relief(3)</p>	 <p>Insertion & Extraction Tools(4)</p>	 <p>PCB Headers & Receptacles(931)</p>



Rectangular Connector Housings(5)

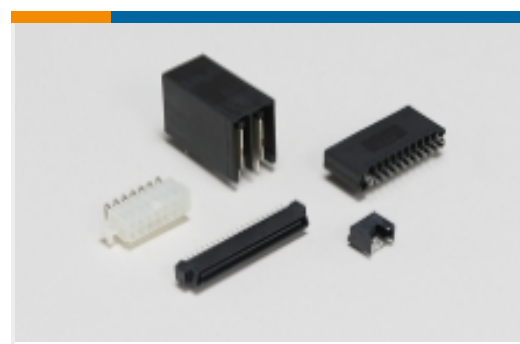

Standard Rectangular Connectors(8)

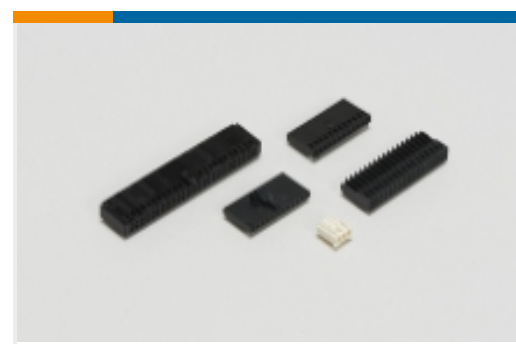
Wire-to-Board Connector Assemblies
& Housings(444)

Customers Also Bought

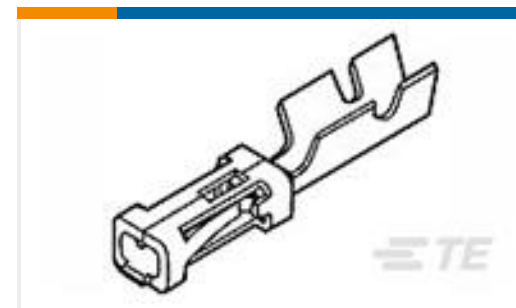
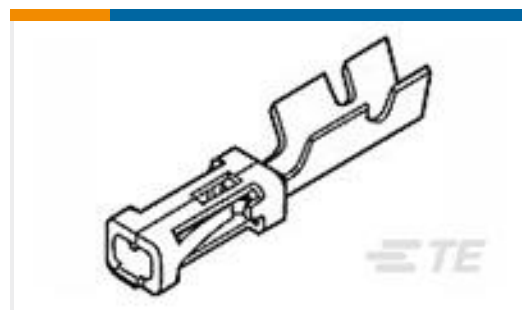
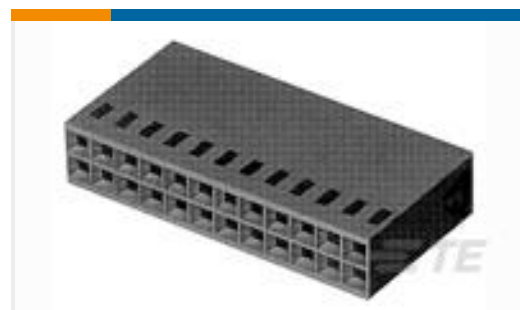
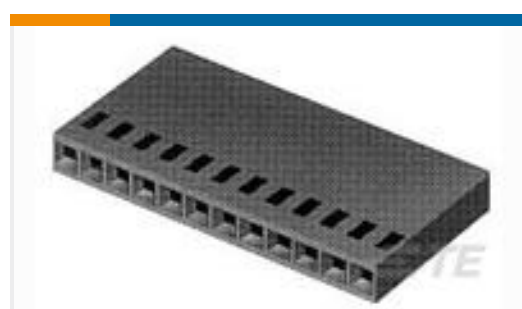
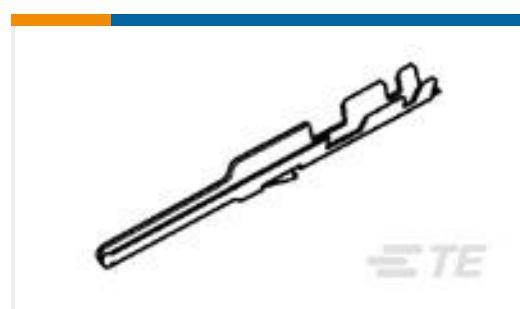
TE Part #87499-7
04 MODIV HSG SR MRKD .100CLTE Part #1-87499-0
05 MODIV HSG COMP SR .100CLTE Part #4-87456-9
04 MODIV HSG COMP DR .100CLTE Part #87666-5
MOD IV RECP PLTD 15 SELTE Part #1-87309-4
MOD V RECP LPTE Part #87456-3
08 MODIV HSG COMP DR .100CLTE Part #87499-8
04 MODIV HSG COMP SR .100CLTE Part #6609052-1
6VN1=F7407 S0TE Part #1-87499-1
06 MODIV HSG SR MRKD .100CLTE Part #5-102107-3
MOD IV PIN LP LF

Documents

CAD Files

3D PDF

English

Customer View Model

[ENG_CVM_87499-4_T.2d_dxf.zip](#)

English

Customer View Model

[ENG_CVM_87499-4_T.3d_igs.zip](#)



English

Customer View Model

[ENG_CVM_87499-4_T.3d_stp.zip](#)

English

By downloading the CAD file I accept and agree to the [Terms and Conditions](#) of use.

Datasheets & Catalog Pages

[AMPMODU_INTERCONNECTION_SYSTEM_SECTION5_CONT](#)

English

Product Specifications

[Product Specification](#)

English

Agency Approvals

[UL](#)

English