

1744417-9 ✓ ACTIVE

Economy Power 2.5

TE Internal #: 1744417-9

Housing, Receptacle, Wire-to-Board, 9 Position, .098 in [2.5 mm]

Centerline, Crimp, 1 Row, Natural, Mating Retention, Wire & Cable,

Economy Power 2.5

[View on TE.com >](#)



Connectors > PCB Connectors > Wire-to-Board Connectors > Wire-to-Board Connector Assemblies & Housings



Connector Product Type: **Housing**

Connector & Housing Type: **Receptacle**

Connector System: **Wire-to-Board**

Number of Positions: **9**

Centerline (Pitch): **2.5 mm [ .098 in ]**

### Features

#### Product Type Features

Connector Product Type	Housing
Connector & Housing Type	Receptacle
Connector System	Wire-to-Board
Sealable	No
Connector & Contact Terminates To	Wire & Cable

#### Configuration Features

Number of Positions	9
Number of Rows	1

#### Electrical Characteristics

Operating Voltage	250 VAC
-------------------	---------

#### Body Features

Primary Product Color	Natural
-----------------------	---------

#### Contact Features

--	--



Contact Layout	Inline
----------------	--------

Contact Type	Socket
--------------	--------

### Termination Features

Termination Method to Wire & Cable	Crimp
------------------------------------	-------

### Mechanical Attachment

Strain Relief	Without
---------------	---------

Panel Mount Feature	Without
---------------------	---------

PCB Mount Retention	Without
---------------------	---------

Mating Retention Type	Latch
-----------------------	-------

Mating Retention	With
------------------	------

Connector Mounting Type	Cable Mount (Free-Hanging)
-------------------------	----------------------------

### Housing Features

Housing Entry Configuration	Both Ends Closed
-----------------------------	------------------

Housing Material	Nylon
------------------	-------

Centerline (Pitch)	2.5 mm [.098 in]
--------------------	------------------

### Dimensions

Connector Length	24.8 mm [.975 in]
------------------	-------------------

Connector Height	5.7 mm [.224 in]
------------------	------------------

### Usage Conditions

Operating Temperature Range	-55 – 105 °C [-67 – 221 °F]
-----------------------------	-----------------------------

### Operation/Application

Circuit Application	Power
---------------------	-------

### Industry Standards

Glow Wire Rating	Glow Wire
------------------	-----------

UL Flammability Rating	UL 94V-0
------------------------	----------

### Packaging Features

Packaging Quantity	500
--------------------	-----

Packaging Method	Bag
------------------	-----

### Product Compliance

[For compliance documentation, visit the product page on TE.com>](#)

EU RoHS Directive 2011/65/EU	Compliant
------------------------------	-----------





EU ELV Directive 2000/53/EC	Compliant
China RoHS 2 Directive MIIT Order No 32, 2016	No Restricted Materials Above Threshold
EU REACH Regulation (EC) No. 1907/2006	Current ECHA Candidate List: JUNE 2023 (235) Candidate List Declared Against: JUNE 2023 (235) Does not contain REACH SVHC
Halogen Content	Not Low Halogen - contains Br or Cl > 900 ppm.
Solder Process Capability	Not applicable for solder process capability

Product Compliance Disclaimer

This information is provided based on reasonable inquiry of our suppliers and represents our current actual knowledge based on the information they provided. This information is subject to change. The part numbers that TE has identified as EU RoHS compliant have a maximum concentration of 0.1% by weight in homogenous materials for lead, hexavalent chromium, mercury, PBB, PBDE, DBP, BBP, DEHP, DIBP, and 0.01% for cadmium, or qualify for an exemption to these limits as defined in the Annexes of Directive 2011/65/EU (RoHS2). Finished electrical and electronic equipment products will be CE marked as required by Directive 2011/65/EU. Components may not be CE marked. Additionally, the part numbers that TE has identified as EU ELV compliant have a maximum concentration of 0.1% by weight in homogenous materials for lead, hexavalent chromium, and mercury, and 0.01% for cadmium, or qualify for an exemption to these limits as defined in the Annexes of Directive 2000/53/EC (ELV). Regarding the REACH Regulation, the information TE provides on SVHC in articles for this part number is based on the latest European Chemicals Agency (ECHA) 'Guidance on requirements for substances in articles' posted at this URL: <https://echa.europa.eu/guidance-documents/guidance-on-reach>

## Compatible Parts

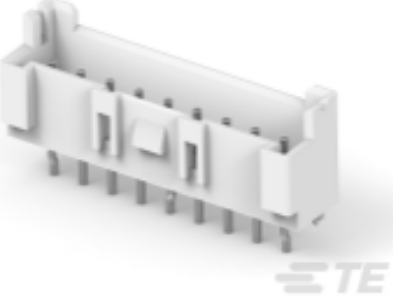
 <p>TE Part # 1969443-9 EP 2.5 TPA Retainer, 9 Pos</p>	 <p>TE Part # 1744423-1 EP 2.5 RCPT CONTACT, 24-20 AWG</p>	 <p>TE Part # 2110989-1 EP 2.5 RCPT CONTACT, 26-22 AWG</p>	 <p>TE Part # 1744426-9 Header Housing Assy, EP 2.5 RA, 9 Pos.</p>
 <p>TE Part # 2132415-9 EP2.5 Shrouded HDR ASSY 9P VERT w /o boss</p>	 <p>TE Part # 2404280-9 EP 2.5 HDR, GLOW WIRE, 9P</p>	 <p>TE Part # 2132230-9 EP2.5 Shrouded HDR ASSY 9P VER</p>	 <p>TE Part # 1744418-9 9 POS EP 2.5 HDR, GLOW WIRE</p>

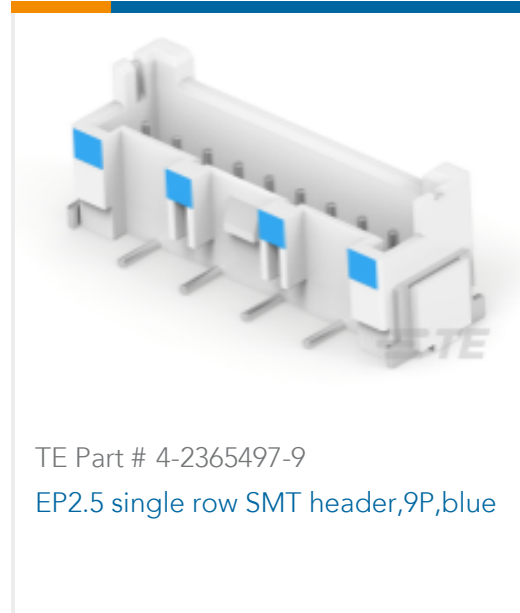
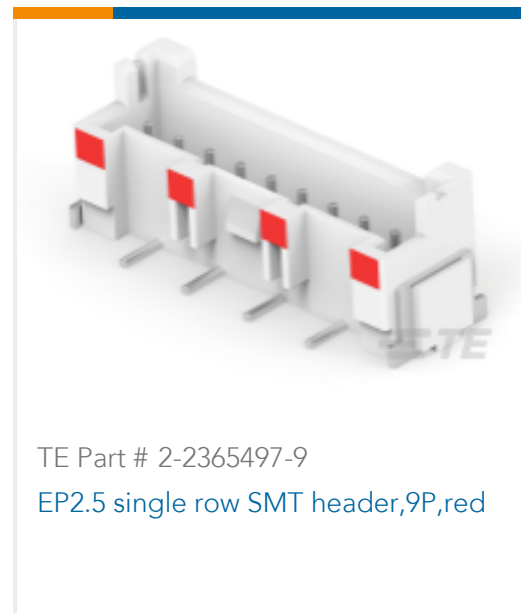

Also in the Series | Economy Power 2.5

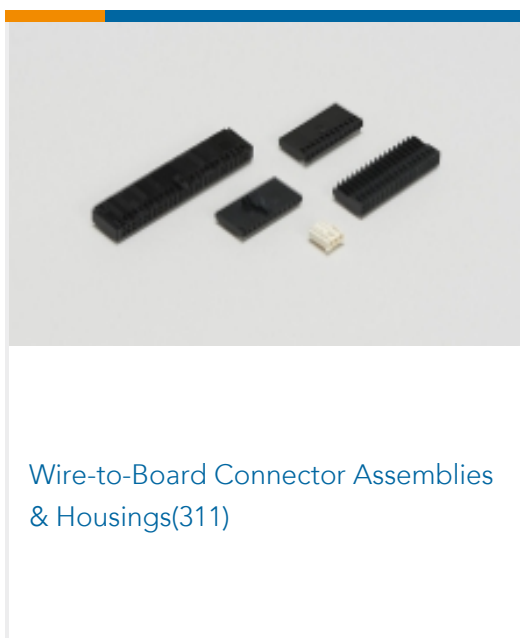
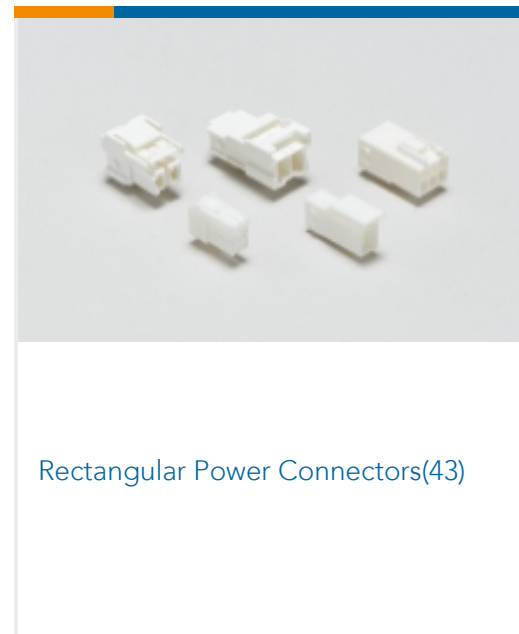
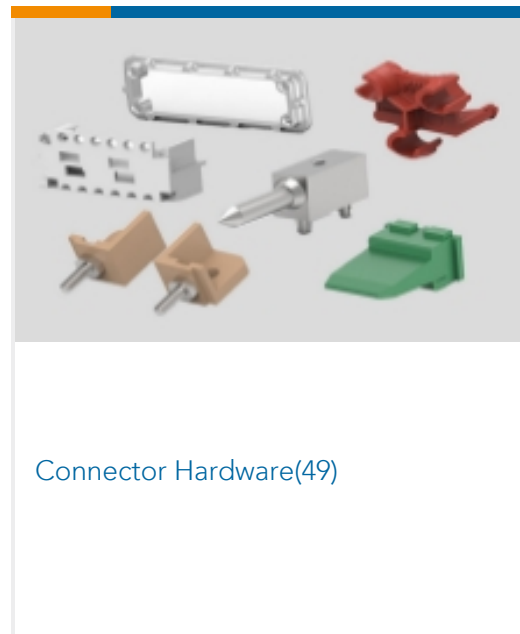
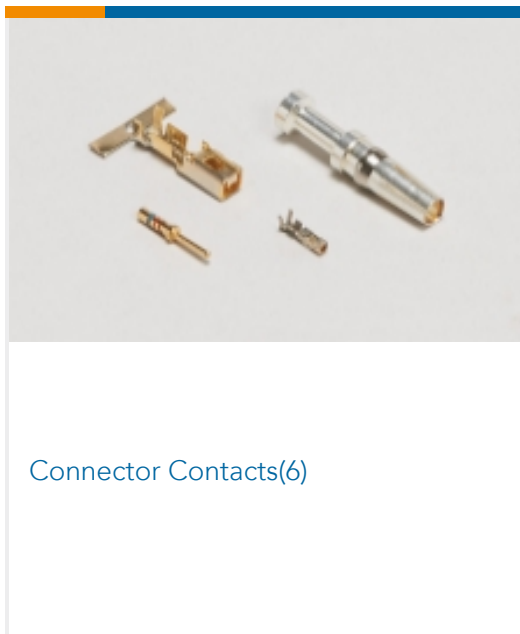

Customers Also Bought





TE Part #1-1123722-7  
3.96 EP PLUG HSG 7P(NATURAL)



TE Part #1-1123724-2  
3.96EP HDR ASSY 2(3)P NATURAL



TE Part #1-2316952-6  
3.96 EP HDR ASSY 6P,NO PIN 2,4



TE Part #1123721-1  
EP CONN. REC CONTACT



TE Part #1-2132230-0  
EP2.5 Shrouded HDR ASSY 10P VE

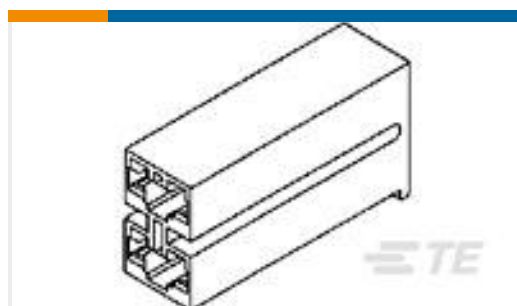

TE Part #1-172210-2  
2P PL MK-2 187(4.8 MM) HOUSING REC

## Documents

### Product Drawings

[9 POS EP 2.5 HSG, GLOW WIRE](#)

English

### CAD Files

[3D PDF](#)

3D

Customer View Model

[ENG\\_CVM\\_CVM\\_1744417-9\\_D.2d\\_dxf.zip](#)

English

Customer View Model

[ENG\\_CVM\\_CVM\\_1744417-9\\_D.3d\\_igs.zip](#)

English

Customer View Model

[ENG\\_CVM\\_CVM\\_1744417-9\\_D.3d\\_stp.zip](#)

English

By downloading the CAD file I accept and agree to the [Terms and Conditions](#) of use.

### Datasheets & Catalog Pages

[7-1773461-6\\_EP2.5\\_Connector\\_Series](#)

English

### Product Specifications

[Application Specification](#)

English

### Agency Approvals

[UL Report](#)

1744417-9

Housing, Receptacle, Wire-to-Board, 9 Position, .098 in [2.5 mm] Centerline, Crimp, 1 Row, Natural, Mating Retention, Wire & Cable, Economy Power 2.5



English