

MLVC

Multilayer varistor general type ESD suppressor

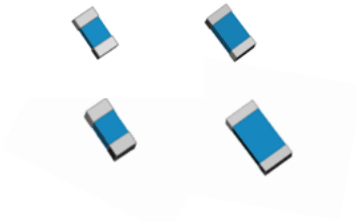

Product features

- Four compact footprint options 0402 (1005 metric), 0603 (1608 metric), 0805 (2012 metric), 1206 (3216 metric)
- Working voltage: 12 Vdc to 68 Vdc
8.5 Vac to 48 Vac
- Absorbs high energy transient voltages seen in EFT and inductive load
- Fast response time to protect downstream circuits

Applications

- ESD port protection for mobile/smart phones
- Game console ESD port protection
- Set-top-boxes
- Tablets, notebooks, netbooks, laptops
- Media players
- Medical equipment
- Computers and peripherals ESD port protection
- Consumer electronics
- Industrial: Measuring devices, instruments, controllers

Environmental compliance



Ordering part number

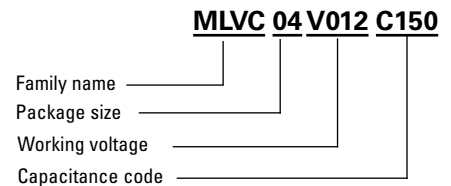

Product specifications

Part number	Working voltage		Varistor voltage @ 1 mAdc		Maximum clamping voltage 8/20 μ s (V)	Energy Absorption 10/1000 μ s (J)	Peak current 8/20 μ s (A)	Typical capacitance @ 1 MHz (pF)
	(Vdc)	(Vac)	(V)	(ΔV_g)				
MLVC04V012C150	12	8.5	18	$\pm 15\%$	34 @ 1 A	0.05	20	150
MLVC04V014C120	14	10	20	$\pm 10\%$	35 @ 1 A	0.05	20	120
MLVC04V016C100	16	11.3	22	$\pm 10\%$	39 @ 1 A	0.05	20	100
MLVC04V018C090	18	12.7	25	$\pm 10\%$	44 @ 1 A	0.05	20	90
MLVC06V012C210	12	8.5	18	$\pm 15\%$	34 @ 1 A	0.1	30	210
MLVC06V014C190	14	10	20	$\pm 10\%$	35 @ 1 A	0.1	30	190
MLVC06V016C180	16	11.3	22	$\pm 10\%$	39 @ 1 A	0.1	30	180
MLVC06V018C170	18	12.7	25	$\pm 10\%$	44 @ 1 A	0.1	30	170
MLVC06V022C150	22	15.6	30	$\pm 10\%$	53 @ 1 A	0.1	30	150
MLVC06V024C140	24	17	33	$\pm 10\%$	58 @ 1 A	0.1	30	140
MLVC06V026C120	26	18.4	36	$\pm 10\%$	63 @ 1 A	0.1	30	120
MLVC06V030C100	30	21.2	42	$\pm 10\%$	74 @ 1 A	0.1	30	100
MLVC06V033C080	33	23.3	45	$\pm 10\%$	79 @ 1 A	0.1	35	80
MLVC08V012C220	12	8.5	18	$\pm 15\%$	34 @ 1 A	0.1	35	220
MLVC08V014C200	14	10	20	$\pm 10\%$	35 @ 1 A	0.1	35	200
MLVC08V016C190	16	11.3	22	$\pm 10\%$	39 @ 1 A	0.1	35	190
MLVC08V018C180	18	12.7	25	$\pm 10\%$	44 @ 1 A	0.1	35	180
MLVC08V022C175	22	15.6	30	$\pm 10\%$	53 @ 1 A	0.1	35	175
MLVC08V024C170	24	17	33	$\pm 10\%$	58 @ 1 A	0.1	35	170
MLVC08V026C165	26	18.4	36	$\pm 10\%$	63 @ 1 A	0.1	35	165
MLVC08V030C150	30	21.2	42	$\pm 10\%$	74 @ 1 A	0.1	35	150
MLVC08V033C120	33	23.3	45	$\pm 10\%$	79 @ 1 A	0.1	35	120
MLVC08V038C110	38	27	51	$\pm 10\%$	90 @ 1 A	0.1	35	110
MLVC08V042C100	42	30	56	$\pm 10\%$	99 @ 1 A	0.1	35	100
MLVC08V048C080	48	34	62	$\pm 10\%$	110 @ 1 A	0.1	35	80
MLVC12V012C450	12	8.5	18	$\pm 15\%$	34 @ 1 A	0.1	35	450
MLVC12V014C350	14	10	20	$\pm 10\%$	35 @ 1 A	0.1	35	350
MLVC12V016C300	16	11.3	22	$\pm 10\%$	39 @ 1 A	0.1	35	300
MLVC12V018C270	18	12.7	25	$\pm 10\%$	44 @ 1 A	0.1	35	270
MLVC12V022C250	22	15.6	30	$\pm 10\%$	53 @ 1 A	0.1	35	250
MLVC12V024C230	24	17	33	$\pm 10\%$	58 @ 1 A	0.1	35	230
MLVC12V026C220	26	18.4	36	$\pm 10\%$	63 @ 1 A	0.1	35	220
MLVC12V030C200	30	21.2	42	$\pm 10\%$	74 @ 1 A	0.1	35	200
MLVC12V033C180	33	23.3	45	$\pm 10\%$	79 @ 1 A	0.1	35	180
MLVC12V038C170	38	27	51	$\pm 10\%$	90 @ 1 A	0.1	35	170
MLVC12V042C160	42	30	56	$\pm 10\%$	99 @ 1 A	0.1	35	160
MLVC12V048C150	48	34	62	$\pm 10\%$	110 @ 1 A	0.1	35	150
MLVC12V056C140	56	40	72	$\pm 10\%$	127 @ 1 A	0.1	35	140
MLVC12V060C120	60	45	76	$\pm 10\%$	134 @ 1 A	0.1	35	120
MLVC12V065C100	65	46	82	$\pm 10\%$	144 @ 1 A	0.1	35	100
MLVC12V068C090	68	48	86	$\pm 10\%$	151 @ 1 A	0.1	35	90

Construction

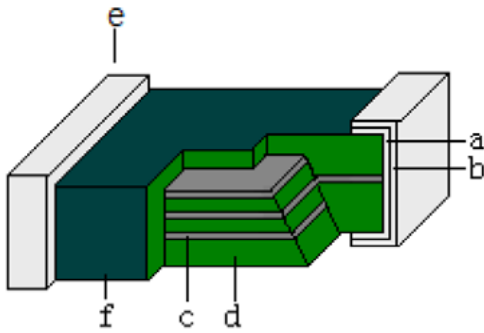

Component	Material
a. Ag layer	Ag
b. Ni/Sn plating	Ni-Sn
c. Inner electrode	Pd/Ag
d. Body	ZnO
e. Terminal electrode	Ag layer and Ni/Sn plating
f. Glass layer	Si-Bi

Dimensions—mm (in)

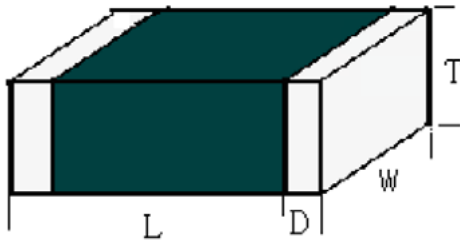

Part size	L	W	T	D
MLVC04	1.0 ± 0.15 (0.04 ± 0.006)	0.5 ± 0.15 (0.02 ± 0.006)	0.5 ± 0.15 (0.02 ± 0.006)	0.25 ± 0.1 (0.01 ± 0.004)
MLVC06	1.6 ± 0.2 (0.063 ± 0.008)	0.8 ± 0.2 (0.031 ± 0.008)	0.8 ± 0.2 (0.031 ± 0.008)	0.3 ± 0.2 (0.01 ± 0.008)
MLVC08	2.0 ± 0.2 (0.079 ± 0.008)	1.2 ± 0.2 (0.047 ± 0.008)	0.9 ± 0.2 (0.035 ± 0.008)	0.5 ± 0.3 (0.02 ± 0.012)
MLVC12	3.2 ± 0.2 (0.126 ± 0.008)	1.6 ± 0.2 (0.063 ± 0.008)	1.1 ± 0.2 (0.043 ± 0.008)	0.5 ± 0.3 (0.02 ± 0.012)

General specifications

Operating temperature: -55 °C to +125 °C

Solderability: +245 ± 5 °C, 5 ± 1 s

Resistance to soldering: +260 ± 5 °C, 10 ± 1 s

Low temperature resistance: -55 ± 2 °C, 1000 hours

Vibration: 1.5 mm, A period of 2 hours in each of 3 mutually perpendicular directions, 10 Hz to 55 Hz to 10 Hz for 1 minute

High temperature resistance: 1000 hours, +125 ± 2 °C.

High temperature load: Applied voltage: Working voltage, Testing time: 1000 hours, +85 ± 2 °C.

Static humidity: 90% to 95% RH, +60 °C ± 2 °C, 1000 hours

Thermal shock: -55 °C, 30 ± 3 minutes, +125 °C, 30 ± 3 minutes, 32 cycles

Paper tape: MLVC04, MLVC06, MLVC08

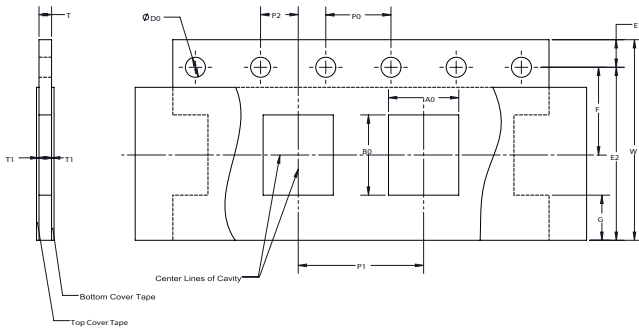

Dimension	MLVC04	MLVC06	MLVC08
W	8 ± 0.3	8 ± 0.3	8 ± 0.3
F	3.5 ± 0.05	3.5 ± 0.05	3.5 ± 0.05
E1	1.75 ± 0.1	1.75 ± 0.1	1.75 ± 0.1
P0	4 ± 0.1	4 ± 0.1	4 ± 0.1
P1	2.0 ± 0.05	4.0 ± 0.2	4.0 ± 0.2
P2	2.0 ± 0.1	2.0 ± 0.1	2.0 ± 0.1
D0	1.5 + 0.1/-0	1.5 + 0.1/-0	1.5 + 0.1/-0
A0	0.65 ± 0.1	1.1 ± 0.2	1.5 ± 0.2
B0	1.15 ± 0.1	1.9 ± 0.2	2.3 ± 0.2
T	0.8 max	1.1 max	1.1 max
Qty	10,000 parts per 7" reel	4000 parts per 7" reel	4000 parts per 7" reel

Embossed tape: MLVC12

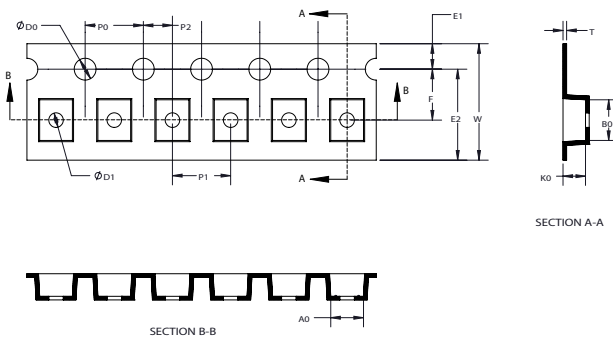

Dimension	MLVC12
W	8.1 +/- 0.2
P1	4.0 +/- 0.10
E1	1.75 +/- 0.10
E2	6.25 min
F	3.50 +/- 0.10
D0	1.55 +/- 0.05
D1	1.00 +/- 0.10
P ₀	4.0 +/- 0.10
P ₂	2.0 +/- 0.05
A ₀	1.90 +/- 0.10
B ₀	3.51 +/- 0.10
T	0.23 +/- 0.10
K ₀	1.27 +/- 0.10
Qty	3000 parts per 7" reel

Wave solder profile

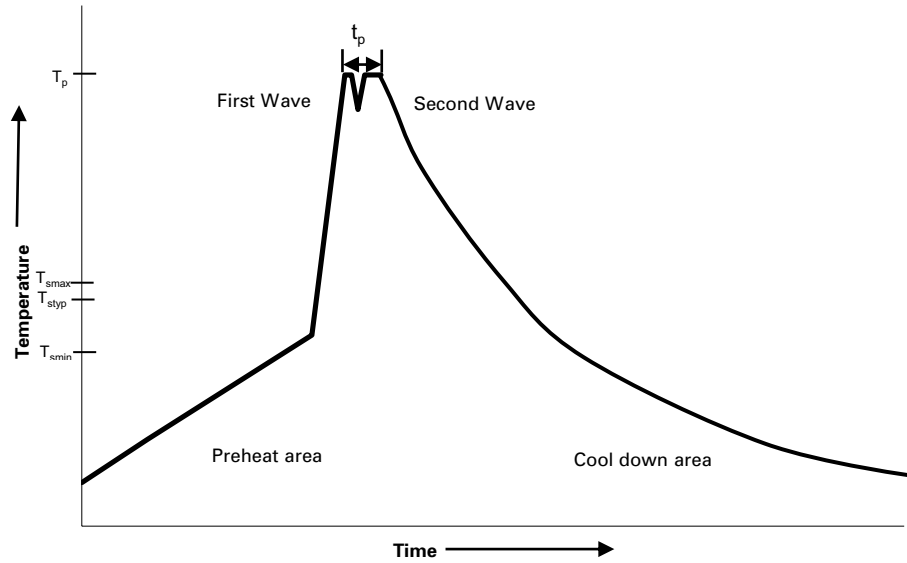

Reference EN 61760-1:2006

Profile feature	Standard SnPb solder	Lead (Pb) free solder
Preheat	• Temperature min. (T_{smin})	100 °C
	• Temperature typ. (T_{styp})	120 °C
	• Temperature max. (T_{smax})	130 °C
	• Time (T_{smin} to T_{smax}) (t_s)	70 seconds
Δ preheat to max Temperature	150 °C max.	150 °C max.
Peak temperature (T_p)*	235 °C – 260 °C	250 °C – 260 °C
Time at peak temperature (t_p)	10 seconds max 5 seconds max each wave	10 seconds max 5 seconds max each wave
Ramp-down rate	~ 2 K/s min ~3.5 K/s typ ~5 K/s max	~ 2 K/s min ~3.5 K/s typ ~5 K/s max
Time 25 °C to peak temperature	4 minutes	4 minutes

Manual solder

+350 °C, 4-5 seconds (by soldering iron), generally manual hand soldering is not recommended.

Solder reflow profile

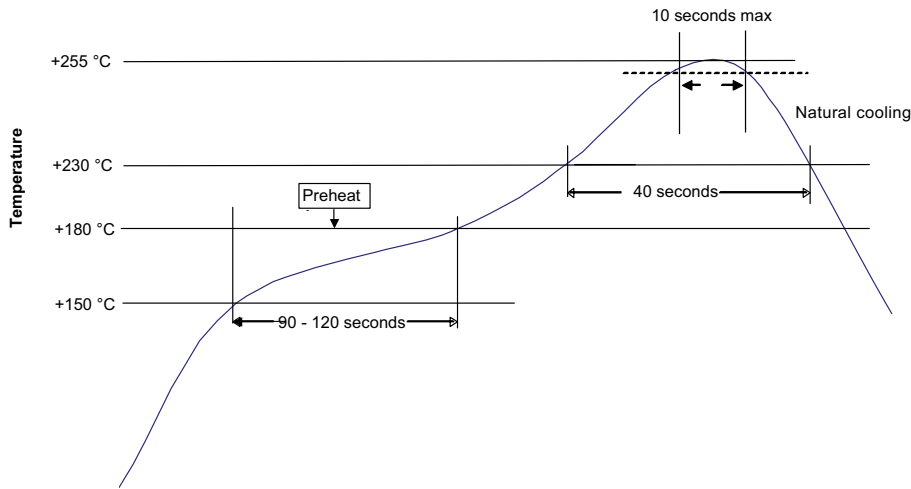

Profile feature	Parameters	
Preheat and soak	• Temperature min.	+150 °C
	• Temperature max.	+180 °C
	• Time	60-120 seconds
Liquidous temperature	+230 °C	
Time at liquidous	40 seconds	
Peak package body temperature	+255 °C	
Time	10 seconds max	

Life Support Policy: Eaton does not authorize the use of any of its products for use in life support devices or systems without the express written approval of an officer of the Company. Life support systems are devices which support or sustain life, and whose failure to perform, when properly used in accordance with instructions for use provided in the labeling, can be reasonably expected to result in significant injury to the user.

Eaton reserves the right, without notice, to change design or construction of any products and to discontinue or limit distribution of any products. Eaton also reserves the right to change or update, without notice, any technical information contained in this bulletin.

Eaton
Electronics Division
1000 Eaton Boulevard
Cleveland, OH 44122
United States
Eaton.com/electronics

© 2021 Eaton
All Rights Reserved
Printed in USA
Publication No. 11237 BU-MC20216
January 2021

Eaton is a registered trademark.
All other trademarks are property of their respective owners.

Follow us on social media to get the latest product and support information.

