

Features

- 2W single and dual outputs in DIP14
- 3kVDC/1s or 4kVDC/1s isolation
- Optional continuous short circuit protection
- UL94V-0 package material
- Efficiency up to 85%
- Suitable for IGBT applications

Unregulated Converters



RJZ & RGZ

**2 Watt
DIP14
Single and Dual
Output**

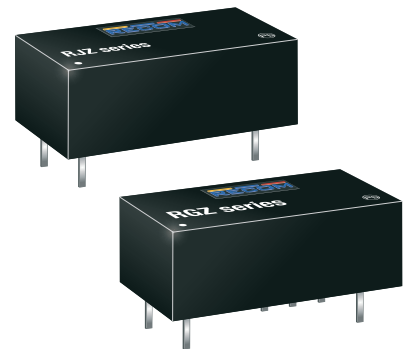

IEC/EN60950-1 certified
IEC/EN60601-1 certified

Description

The RJZ and RGZ series converters are available in DIP14 packages, so can be used for applications where component height is restricted. The wide selection of input voltage and output voltage options plus an I/O-Isolation of 3kVDC or 4kVDC as standard makes these converters suitable for many industrial, medical and IGBT applications.

Selection Guide

Part Number	nom. Input Voltage [VDC]	Output Voltage [VDC]	Output Current [mA]	Efficiency typ. ⁽¹⁾ [%]	max. Capacitive Load ⁽²⁾ [µF]
RJZ-xx3.3S ^(3,4)	3.3, 5, 9, 12, 15, 24	3.3	606	70-75	3300
RJZ-xx05S ^(3,4)	3.3, 5, 9, 12, 15, 24	5	400	78-85	1200
RJZ-xx09S ^(3,4)	3.3, 5, 9, 12, 15, 24	9	222	78-84	1200
RJZ-xx12S ^(3,4)	3.3, 5, 9, 12, 15, 24	12	166	80-85	680
RJZ-xx15S ^(3,4)	3.3, 5, 9, 12, 15, 24	15	133	82-85	680
RJZ-xx24S ^(3,4)	3.3, 5, 9, 12, 15, 24	24	83	80-85	220
RGZ-xx3.3D ^(3,4)	3.3, 5, 9, 12, 15, 24	±3.3	±303	75	±1500
RGZ-xx05D ^(3,4)	3.3, 5, 9, 12, 15, 24	±5	±200	75-82	±470
RGZ-xx09D ^(3,4)	3.3, 5, 9, 12, 15, 24	±9	±111	75-80	±470
RGZ-xx12D ^(3,4)	3.3, 5, 9, 12, 15, 24	±12	±84	78-82	±220
RGZ-xx15D ^(3,4)	3.3, 5, 9, 12, 15, 24	±15	±66	80-84	±220
RGZ-xx24D ^(3,4)	3.3, 5, 9, 12, 15, 24	±24	±42	82-84	±100
RGZ-xx1509D ^(3,4)	5, 12, 24	+15/-9	+67/-111	70-81	±330

Notes:

- Note1: Efficiency is tested at nominal input and full load at +25°C ambient
 Note2: Max Cap Load is tested at nominal input and full resistive load and is defined as the capacitive load that will allow start up in under 1s without damage to the converter

Model Numbering

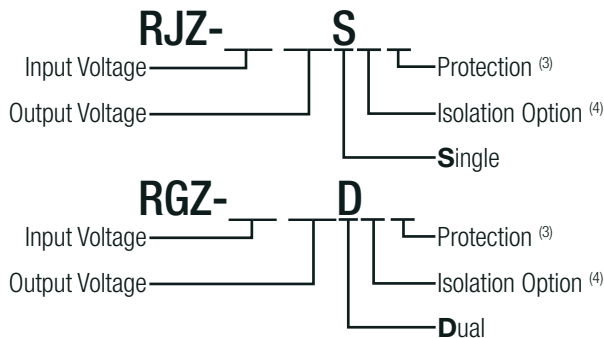

Notes:

- Note3: standard part is without continuous short circuit protection
 add suffix „P“ for continuous short circuit protection
 Note4: add suffix “/H” for 4kVDC/1s isolation
 or add suffix “/HP” for continuous short circuit protection and 4kVDC/1s isolation

Ordering Examples

- RJZ-1212S = 12V Input, 12V Output, Single
 RJZ-0505S/P = 5V Input, 5V Output, Single, continuous short circuit protection
 RGZ-0505D/HP = 5V Input, 5V Output, Dual, 4kVDC/1s isolation and continuous short circuit protection

Specifications (measured @ Ta= 25°C, nom. Vin, full load and after warm-up unless otherwise stated)

BASIC CHARACTERISTICS

Parameter	Condition	Min.	Typ.	Max.
Input Voltage Range			±10%	
Minimum Load		0%		
Internal Operating Frequency	RGZ-xx1509D	20kHz 20kHz	50kHz 45kHz	90kHz
Output Ripple and Noise	20MHz BW			150mVp-p

Efficiency vs. Load

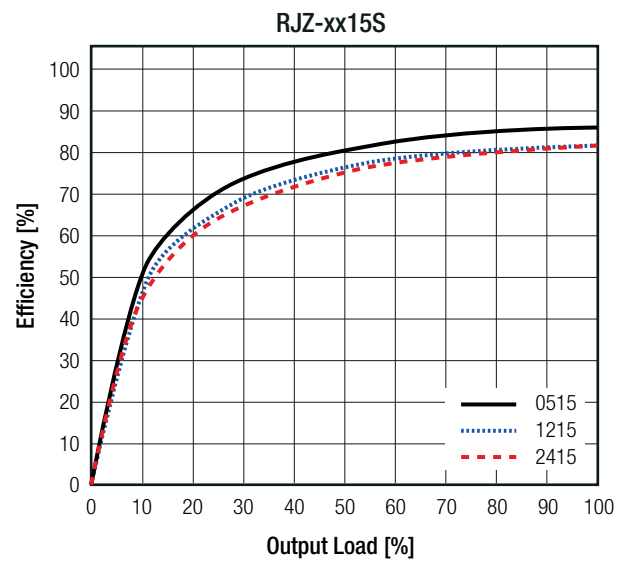
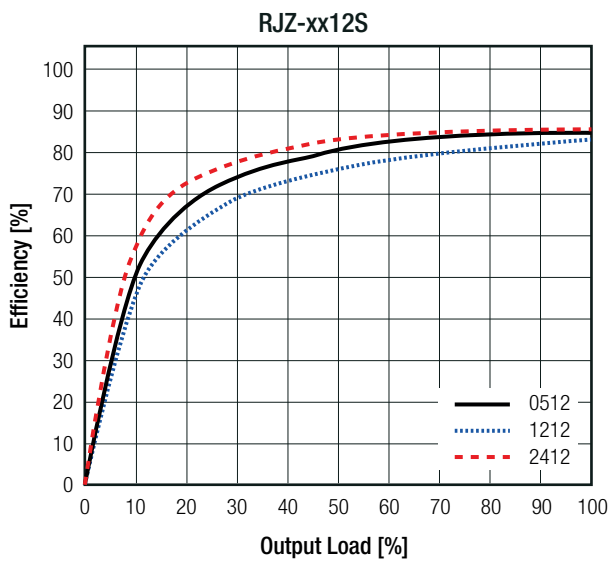
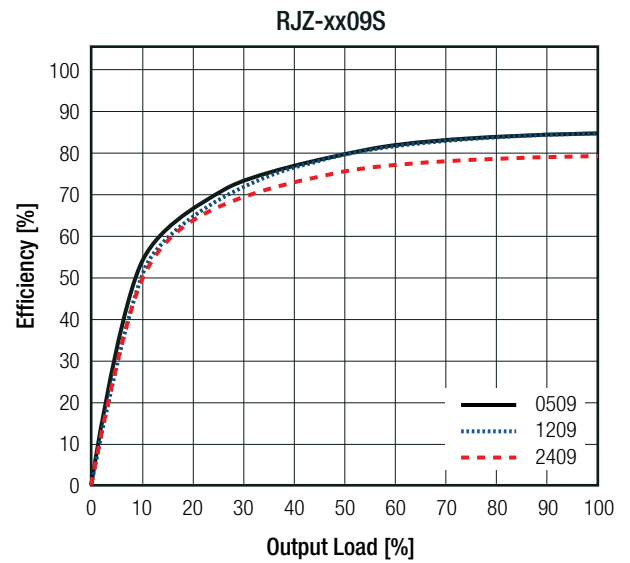
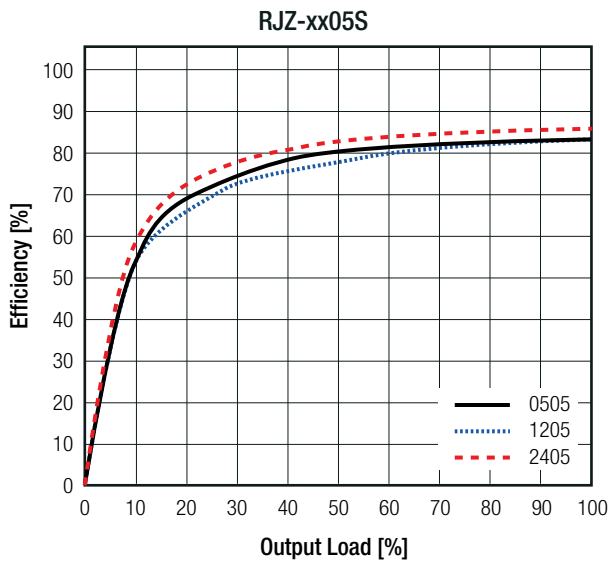

continued on next page

Specifications (measured @ Ta= 25°C, nom. Vin, full load and after warm-up unless otherwise stated)

Efficiency vs. Load

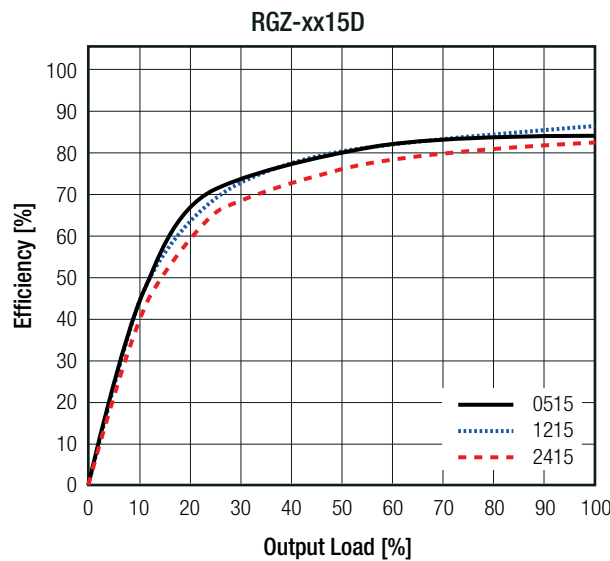
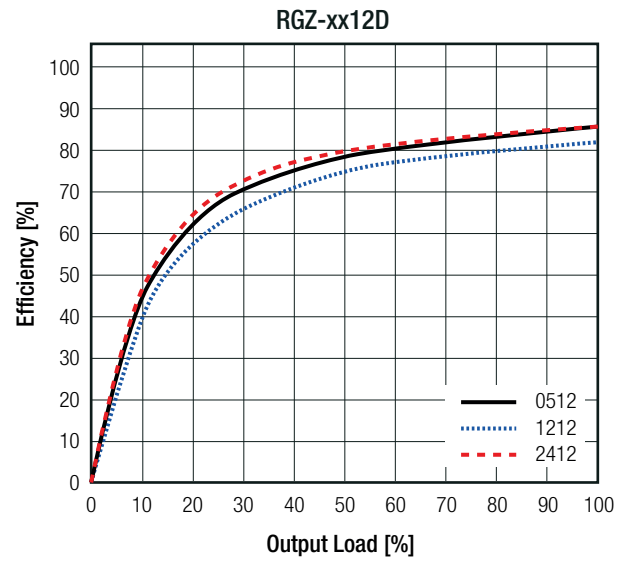
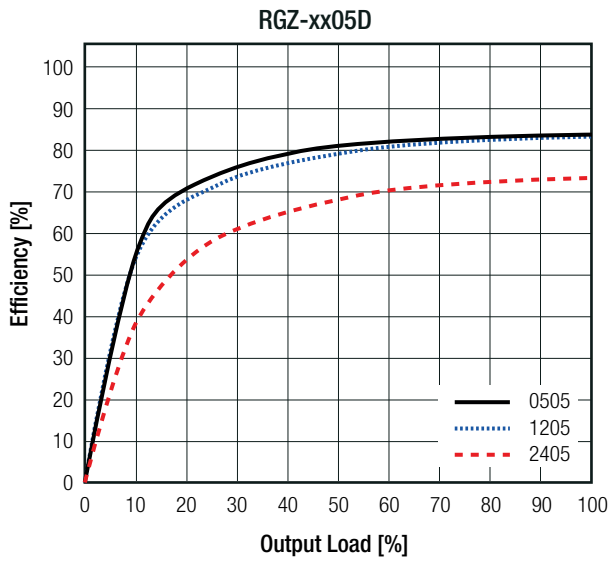

REGULATIONS			
Parameter	Condition		Value
Output Accuracy			±5.0% max.
Line Regulation	low line to high line		±1.2% of 1.0% Vin typ.
Load Regulation ⁽⁵⁾	10% to 100% load	3.3Vout	20.0% max.
		5Vout	15.0% max.
		9, 12, 15, 24 and +15/-9Vout	10.0% max.
<p>Notes:</p> <p>Note5: Operation below 10% load will not harm the converter, but specifications may not be met</p>			

continued on next page

Specifications (measured @ Ta= 25°C, nom. Vin, full load and after warm-up unless otherwise stated)

Deviation vs. Load

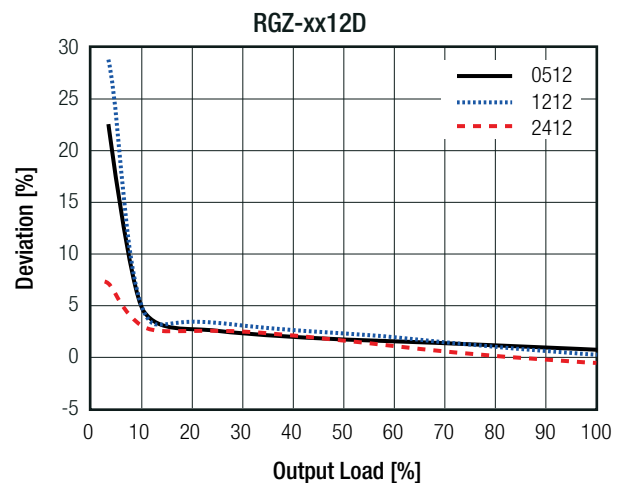
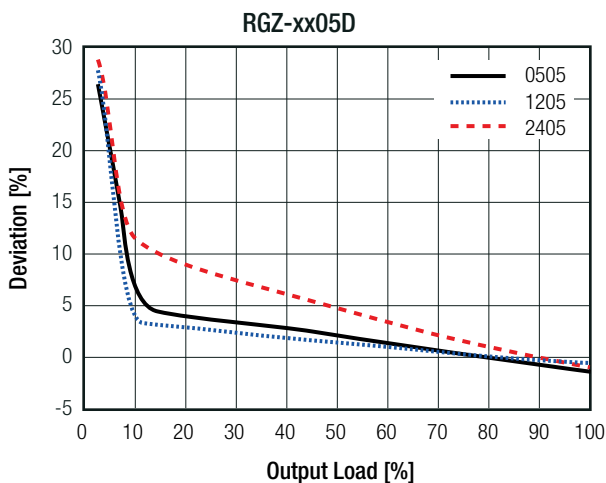
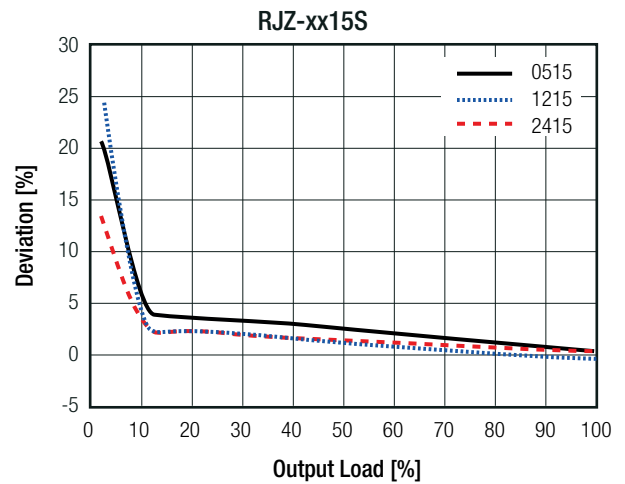
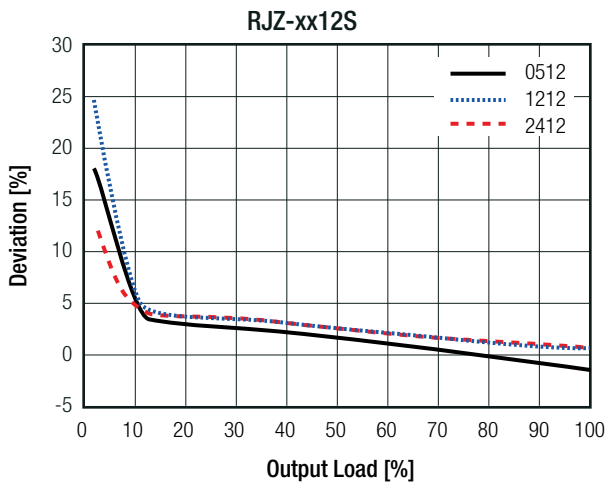
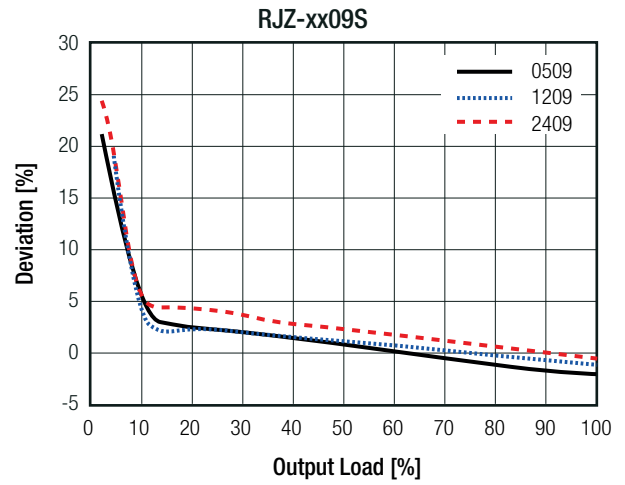
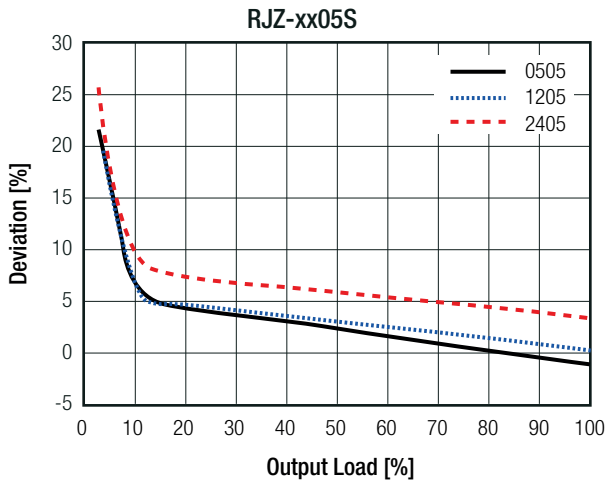

continued on next page

Specifications (measured @ Ta= 25°C, nom. Vin, full load and after warm-up unless otherwise stated)

Deviation vs. Load

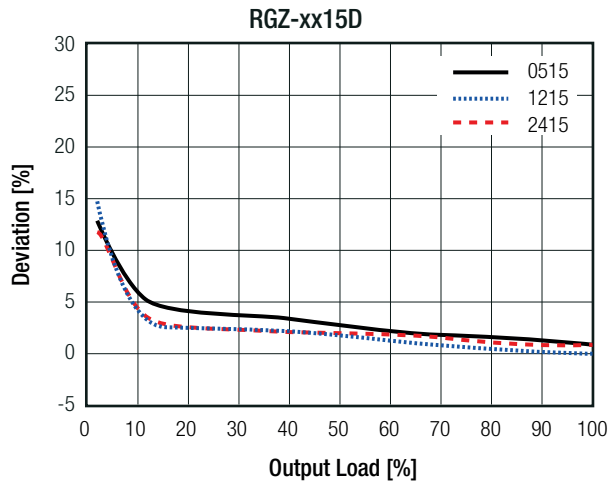

PROTECTIONS

Parameter	Type		Value
Short Circuit Protection (SCP)	without suffix with suffix "/P"		1 second continuous
Isolation Voltage ⁽⁶⁾	I/P to O/P	without suffix	tested for 1 second rated for 1 minute 3kVDC 1.5kVAC/60Hz
		with suffix "/H"	tested for 1 second rated for 1 minute 4kVDC 2kVAC/60Hz
Isolation Resistance			15GΩ min.
Isolation Capacitance			120pF max.
Insulation Grade			basic (IEC/EN60950-1) functional (IEC/EN60601-1)

Notes:

Note6: For repeat Hi-Pot testing, reduce the time and/or the test voltage

Note7: Refer to local safety regulations if input over-current protection is required. Recommended fuse: slow blow type

ENVIRONMENTAL

Parameter	Condition		Value	
Operating Temperature Range	full load @ free air convection (see graph)		-40°C to +90°C	
Maximum Case Temperature			+110°C	
Temperature Coefficient			±0.02%/K	
Thermal Impedance	0.1m/s, horizontal		56.66K/W	
Operating Altitude			2000m	
Operating Humidity	non-condensing		95% RH max.	
Pollution Degree			PD2	
MTBF	according to MIL-HDBK-217F, G.B.	RJZ	+25°C	893 x 10 ³ hours
			+85°C	208 x 10 ³ hours
		RGZ	+25°C	810 x 10 ³ hours
			+85°C	151 x 10 ³ hours

continued on next page

Specifications (measured @ Ta= 25°C, nom. Vin, full load and after warm-up unless otherwise stated)

Derating Graph
(@ free air convection)

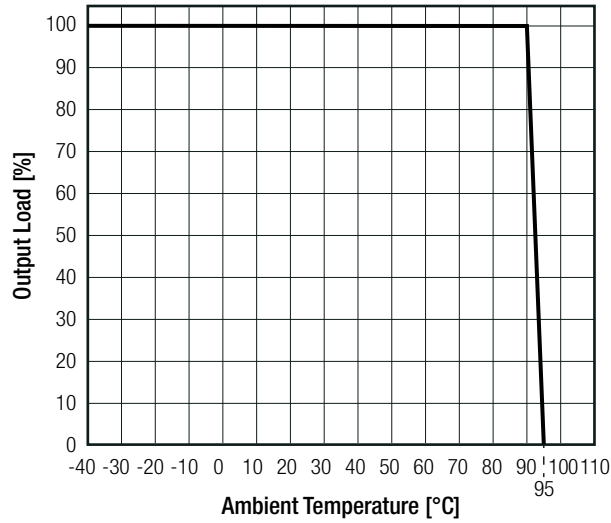

SAFETY AND CERTIFICATIONS		
Certificate Type (Safety)	Report / File Number	Standard
Information Technology Equipment, General Requirements for Safety	SPCLVD1602031	IEC60950-1:2005, 2nd Edition + A2:2013 EN60950-1:2006 + A2:2013
Information Technology Equipment, General Requirements for Safety	E358085 ⁽⁸⁾	UL60950-1, 2nd Edition, 2007 CAN/CSA C22.2 NO. 60950-1, 2nd Edition, 2007
Medical electrical equipment Part 1: General requirements for basic safety and essential performance	WD-SE-R-180676-A0 ⁽⁹⁾	IEC60601-1:2005 + A1:2012, 3rd Edition EN60601-1:2006 + A1:2013 + A12:2014
EAC	RU-AT.49.09571	TP TC 004/2011
RoHS 2+		RoHS-2011/65/EU + AM-2015/863
Notes: Note8: only +15/-9 version Note9: excluded +15/-9 version		

DIMENSION AND PHYSICAL CHARACTERISTICS		
Parameter	Type	Value
Material	case potting PCB	non-conductive black plastic (UL94 V-0) epoxy, (UL94 V-0) FR4, (UL94 V-0)
Dimension (LxWxH)		19.9 x 10.0 x 7.1mm
Weight		2.8g typ.

continued on next page

Specifications (measured @ Ta= 25°C, nom. Vin, full load and after warm-up unless otherwise stated)

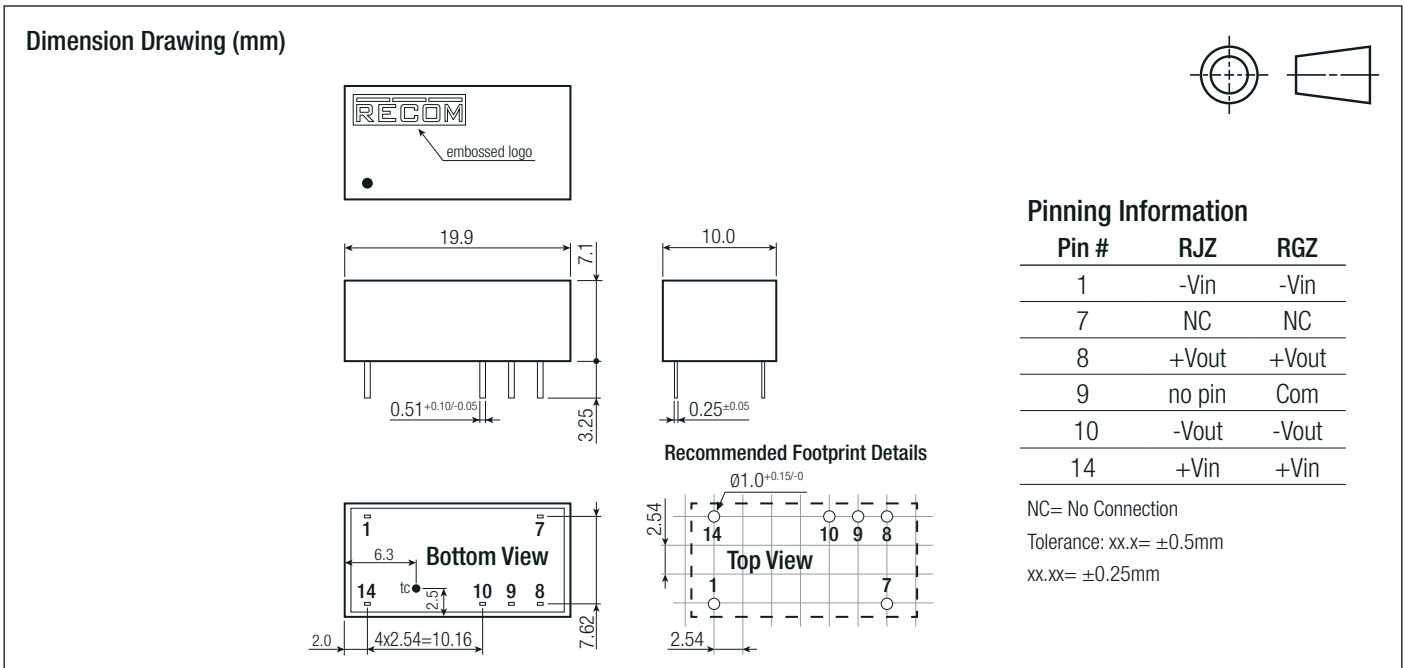

INSTALLATION AND APPLICATION

IGBT Application Circuit

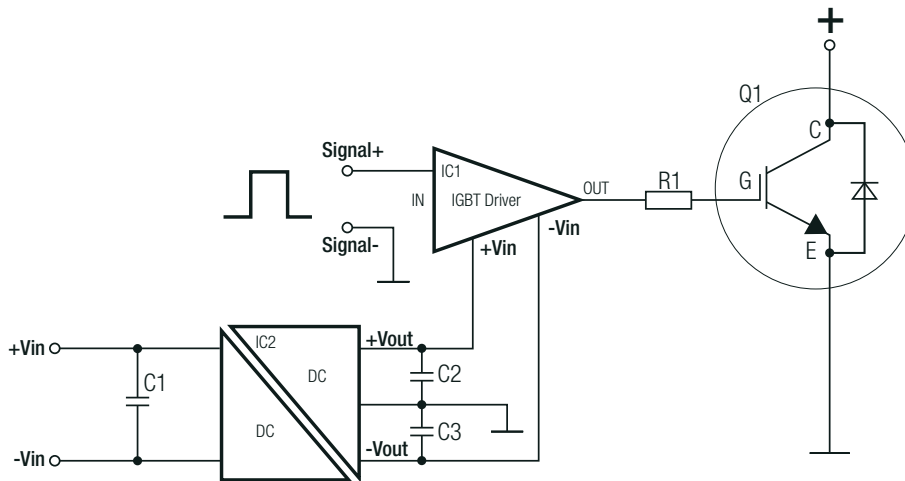

PACKAGING INFORMATION

Parameter	Type	Value
Packaging Dimension (LxWxH)	tube	520.0 x 17.0 x 10.0mm
Packaging Quantity	tube	24pcs
Storage Temperature Range		-55°C to +125°C
Storage Humidity	non-condensing	95% RH max.

The product information and specifications may be subject to changes even without prior written notice. The product has been designed for various applications; its suitability lies in the responsibility of each customer. The products are not authorized for use in safety-critical applications without RECOM's explicit written consent. A safety-critical application is an application where a failure may reasonably be expected to endanger or cause loss of life, inflict bodily harm or damage property. The applicant shall indemnify and hold harmless RECOM, its affiliated companies and its representatives against any damage claims in connection with the unauthorized use of RECOM products in such safety-critical applications.