

### Description

The TSV61x family of single and dual operational amplifiers offers low voltage, low power operation, and rail-to-rail input and output.

The devices also feature an ultra-low input bias current as well as a low input offset voltage.

The TSV61x have a gain bandwidth product of 120 kHz while consuming only 10  $\mu$ A at 5 V.

These features make the TSV61x family ideal for sensor interfaces, battery supplied and portable applications, as well as active filtering.

### Applications

- Battery-powered applications
- Smoke detectors
- Proximity sensors
- Portable devices
- Signal conditioning
- Active filtering
- Medical instrumentation

### Features

- Rail-to-rail input and output
- Low power consumption: 10  $\mu$ A typ at 5 V
- Low supply voltage: 1.5 to 5.5 V
- Gain bandwidth product: 120 kHz typ
- Unity gain stable
- Low input offset voltage: 800  $\mu$ V max (A version)
- Low input bias current: 1 pA typ
- Temperature range: -40 to 85  $^{\circ}$ C

**TSV611ILT/TSV611AILT/  
TSV611AICT**

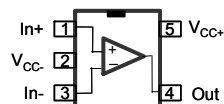

**SOT23-5/SC70-5**

**TSV612IDT/TSV612AIDT**

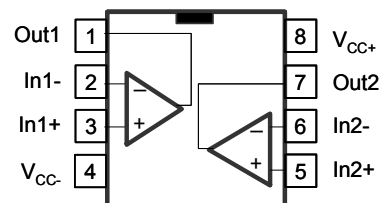

**SOP-8**

**Absolute maximum ratings and operating conditions**

**Table 1. Absolute maximum ratings**

Symbol	Parameter	Value	Unit
$V_{CC}$	Supply voltage <sup>(1)</sup>	6	V
$V_{id}$	Differential input voltage <sup>(2)</sup>	$\pm V_{CC}$	
$V_{in}$	Input voltage <sup>(3)</sup>	$(V_{CC-}) - 0.2$ to $(V_{CC+}) + 0.2$	
$T_{stg}$	Storage temperature	-65 to 150	°C
$R_{thja}$	Thermal resistance junction to ambient <sup>(4) (5)</sup>		°C/W
	SC70-5	205	
	SOT23-5	250	
	SOP8	125	
$T_j$	Maximum junction temperature	150	°C
ESD	HBM: human body model <sup>(6)</sup>	4	kV
	MM: machine model <sup>(7)</sup>	200	V
	CDM: charged device model <sup>(8)</sup>	1.5	kV
	Latch-up immunity	200	mA

1. All voltage values, except differential voltage are with respect to network ground terminal.
2. Differential voltages are the non-inverting input terminal with respect to the inverting input terminal.
3.  $V_{CC}$ - $V_{in}$  must not exceed 6 V.
4. Short-circuits can cause excessive heating and destructive dissipation.
5.  $R_{th}$  are typical values.
6. Human body model: 100 pF discharged through a 1.5 k $\Omega$  resistor between two pins of the device, done for all couples of pin combinations with other pins floating.
7. Machine model: a 200 pF cap is charged to the specified voltage, then discharged directly between two pins of the device with no external series resistor (internal resistor < 5  $\Omega$ ), done for all couples of pin combinations with other pins floating.
8. Charged device model: all pins plus package are charged together to the specified voltage and then discharged directly to ground.

**Table 2. Operating conditions**

Symbol	Parameter	Value	Unit
$V_{CC}$	Supply voltage	1.5 to 5.5	V
$V_{icm}$	Common mode input voltage range	$(V_{CC-}) - 0.1$ to $(V_{CC+}) + 0.1$	
$T_{oper}$	Operating free air temperature range	-40 to 85	°C

### Electrical characteristics

**Table 3. Electrical characteristics at  $V_{CC+} = 1.8$  V with  $V_{CC-} = 0$  V,  $V_{icm} = V_{CC}/2$ ,  $T_{amb} = 25$  °C, and  $R_L$  connected to  $V_{CC}/2$  (unless otherwise specified)**

Symbol	Parameter	Conditions	Min.	Typ.	Max.	Unit
<b>DC performance</b>						
$V_{io}$	Offset voltage	TSV61x			4	mV
		TSV61xA			0.8	
		$T_{min.} < T_{op} < T_{max.}$ TSV61x			5	
		$T_{min.} < T_{op} < T_{max.}$ TSV61xA			2	
$\Delta V_{io}/\Delta T$	Input offset voltage drift			2		$\mu$ V/°C
$I_{io}$	Input offset current ( $V_{out} = V_{CC}/2$ )			1	10 <sup>(1)</sup>	pA
		$T_{min.} < T_{op} < T_{max.}$		1	100	
$I_{ib}$	Input bias current ( $V_{out} = V_{CC}/2$ )			1	10 <sup>(1)</sup>	pA
		$T_{min.} < T_{op} < T_{max.}$		1	100	
CMR	Common mode rejection ratio $20 \log (\Delta V_{ic}/\Delta V_{io})$	0 V to 1.8 V, $V_{out} = 0.9$ V	55	71		dB
		$T_{min.} < T_{op} < T_{max.}$	53			
$A_{vd}$	Large signal voltage gain	$R_L = 10$ k $\Omega$ , $V_{out} = 0.5$ V to 1.3 V	78	83		dB
		$T_{min.} < T_{op} < T_{max.}$	74			
$V_{OH}$	High level output voltage ( $V_{OH} = V_{CC} - V_{out}$ )	$R_L = 10$ k $\Omega$ $T_{min.} < T_{op} < T_{max.}$		4	35 50	mV
$V_{OL}$	Low level output voltage	$R_L = 10$ k $\Omega$ $T_{min.} < T_{op} < T_{max.}$		7	35 50	
$I_{out}$	Isink	$V_o = 1.8$ V $T_{min.} < T_{op} < T_{max.}$	9 9	13		mA
	Isource	$V_o = 0$ V $T_{min.} < T_{op} < T_{max.}$	8 8	10		
$I_{CC}$	Supply current (per operator)	No load, $V_{out} = V_{CC}/2$	6.5	9	12	$\mu$ A
		$T_{min.} < T_{op} < T_{max.}$	6		12.5	
<b>AC performance</b>						
GBP	Gain bandwidth product			100		kHz
$\phi_m$	Phase margin	$R_L = 10$ k $\Omega$ , $C_L = 20$ pF		60		Degrees
$G_m$	Gain margin			9.5		dB
SR	Slew rate	$R_L = 10$ k $\Omega$ , $C_L = 20$ pF, $V_{out} = 0.5$ V to 1.3 V		0.03		V/ $\mu$ s

**Table 3. Electrical characteristics at  $V_{CC+} = 1.8$  V with  $V_{CC-} = 0$  V,  $V_{icm} = V_{CC}/2$ ,  $T_{amb} = 25$  °C, and  $R_L$  connected to  $V_{CC}/2$  (unless otherwise specified) (continued)**

Symbol	Parameter	Conditions	Min.	Typ.	Max.	Unit
$e_n$	Equivalent input noise voltage	$f = 1$ kHz		110		$\frac{nV}{\sqrt{Hz}}$
THD+N	Total harmonic distortion + noise	$F_{in} = 1$ kHz, $A_v = 1$ , $V_{out} = 1$ V <sub>pp</sub> , $R_L = 100$ k $\Omega$ , $BW = 22$ kHz		0.07		%

1. Guaranteed by design.

**Table 4. Electrical characteristics at  $V_{CC+} = 3.3$  V,  $V_{CC-} = 0$  V,  $V_{icm} = V_{CC}/2$ ,  $T_{amb} = 25$  °C,  $R_L$  connected to  $V_{CC}/2$  (unless otherwise specified)**

Symbol	Parameter		Min.	Typ.	Max.	Unit
<b>DC performance</b>						
$V_{io}$	Offset voltage	TSV61x			4	mV
		TSV61xA			0.8	
		$T_{min} < T_{op} < T_{max}$ TSV61x			5	
		$T_{min} < T_{op} < T_{max}$ TSV61xA			2	
$\Delta V_{io}/\Delta T$	Input offset voltage drift			2		$\mu$ V/°C
$I_{io}$	Input offset current			1	10 <sup>(1)</sup>	pA
		$T_{min} < T_{op} < T_{max}$ .		1	100	
$I_{ib}$	Input bias current			1	10 <sup>(1)</sup>	pA
		$T_{min} < T_{op} < T_{max}$ .		1	100	
CMR	Common mode rejection ratio 20 log ( $\Delta V_{ic}/\Delta V_{io}$ )	0 V to 3.3 V, $V_{out} = 1.75$ V	61	76		dB
		$T_{min} < T_{op} < T_{max}$ .	58			
$A_{vd}$	Large signal voltage gain	$R_L = 10$ k $\Omega$ , $V_{out} = 0.5$ V to 2.8 V	85	92		dB
		$T_{min} < T_{op} < T_{max}$ .	83			
$V_{OH}$	High level output voltage ( $V_{OH} = V_{CC} - V_{out}$ )	$R_L = 10$ k $\Omega$ $T_{min} < T_{op} < T_{max}$ .		5	35 50	mV
$V_{OL}$	Low level output voltage	$R_L = 10$ k $\Omega$ $T_{min} < T_{op} < T_{max}$ .		10	35 50	
$I_{out}$	Isink	$V_o = V_{CC}$ $T_{min} < T_{op} < T_{max}$ .	37 35	44		mA
	Isource	$V_o = 0$ V $T_{min} < T_{op} < T_{max}$ .	32 30	38		
$I_{CC}$	Supply current (per operator)	No load, $V_{out} = V_{CC}/2$	6.5	9.5	12.5	$\mu$ A
		$T_{min} < T_{op} < T_{max}$ .	6		13	
<b>AC performance</b>						
GBP	Gain bandwidth product			110		kHz
$\phi_m$	Phase margin	$R_L = 10$ k $\Omega$ , $C_L = 20$ pF		60		Degrees
$G_m$	Gain margin			9.5		dB
SR	Slew rate	$R_L = 10$ k $\Omega$ , $C_L = 20$ pF, $V_{out} = 0.5$ V to 2.8V		0.035		V/ $\mu$ s
$e_n$	Equivalent input noise voltage	$f = 1$ kHz		110		$\frac{nV}{\sqrt{Hz}}$

1. Guaranteed by design.

**Table 5. Electrical characteristics at  $V_{CC+} = 5$  V,  $V_{CC-} = 0$  V,  $V_{icm} = V_{CC}/2$ ,  $T_{amb} = 25$  °C,  $R_L$  connected to  $V_{CC}/2$  (unless otherwise specified)**

Symbol	Parameter		Min.	Typ.	Max.	Unit
<b>DC performance</b>						
$V_{io}$	Offset voltage	TSV61x			4	mV
		TSV61xA			0.8	
		$T_{min} < T_{op} < T_{max}$ TSV61x			5	
		$T_{min} < T_{op} < T_{max}$ TSV61xA			2	
$\Delta V_{io}/\Delta T$	Input offset voltage drift			2		$\mu$ V/°C
$I_{io}$	Input offset current			1	$10^{(1)}$	pA
		$T_{min.} < T_{op} < T_{max.}$		1	100	
$I_{ib}$	Input bias current			1	$10^{(1)}$	pA
		$T_{min.} < T_{op} < T_{max.}$		1	100	
CMR	Common mode rejection ratio $20 \log (\Delta V_{ic}/\Delta V_{io})$	0 V to 5 V, $V_{out} = 2.5$ V	64	80		dB
		$T_{min.} < T_{op} < T_{max.}$	63			
SVR	Supply voltage rejection ratio $20 \log (\Delta V_{cc}/\Delta V_{io})$	$V_{cc} = 1.8$ to 5 V	76	93		dB
		$T_{min.} < T_{op} < T_{max.}$	74			
$A_{vd}$	Large signal voltage gain	$R_L = 10$ k $\Omega$ , $V_{out} = 0.5$ V to 4.5 V	88	93		dB
		$T_{min} < T_{op} < T_{max}$	85			
$V_{OH}$	High level output voltage ( $V_{OH} = V_{CC} - V_{out}$ )	$R_L = 10$ k $\Omega$ $T_{min.} < T_{op} < T_{max.}$		7	35 50	mV
$V_{OL}$	Low level output voltage	$R_L = 10$ k $\Omega$ $T_{min.} < T_{op} < T_{max.}$		16	35 50	
$I_{out}$	Isink	$V_o = V_{CC}$ $T_{min.} < T_{op} < T_{max.}$	52 42	57		mA
	Isource	$V_o = 0$ V $T_{min.} < T_{op} < T_{max.}$	58 49	63		
$I_{CC}$	Supply current (per operator)	No load, $V_{out} = V_{CC}/2$	7.5	10.5	14	$\mu$ A
		$T_{min.} < T_{op} < T_{max.}$	7		15	
<b>AC performance</b>						
GBP	Gain bandwidth product			120		kHz
$\phi_m$	Phase margin	$R_L = 10$ k $\Omega$ , $C_L = 20$ pF		62		Degrees
$G_m$	Gain margin			10		dB
SR	Slew rate	$R_L = 10$ k $\Omega$ , $C_L = 20$ pF, $V_{out} = 0.5$ V to 4.5V		0.04		V/ $\mu$ s

**Table 5. Electrical characteristics at  $V_{CC+} = 5$  V,  $V_{CC-} = 0$  V,  $V_{icm} = V_{CC}/2$ ,  $T_{amb} = 25$  °C,  $R_L$  connected to  $V_{CC}/2$  (unless otherwise specified) (continued)**

Symbol	Parameter		Min.	Typ.	Max.	Unit
$e_n$	Equivalent input noise voltage	$f = 1$ kHz		105		$\frac{nV}{\sqrt{Hz}}$
THD+N	Total harmonic distortion + noise	$F_{in} = 1$ kHz, $A_v = 1$ , $V_{out} = 1$ V <sub>pp</sub> , $R_L = 100$ k $\Omega$ , BW = 22kHz		0.02		%

1. Guaranteed by design.

Figure 1. Supply current vs. supply voltage at  $V_{icm} = V_{CC}/2$

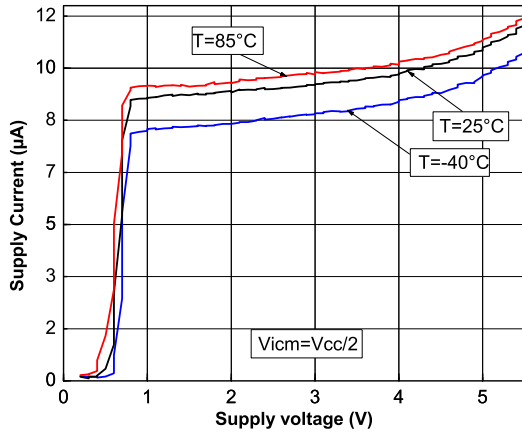

Figure 2. Output current vs. output voltage at  $V_{CC} = 1.5V$

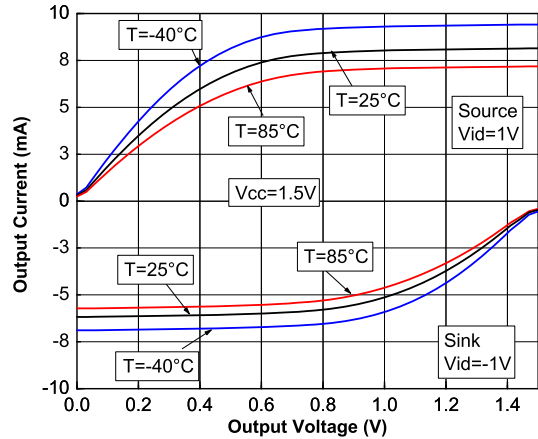

Figure 3. Output current vs. output voltage at  $V_{CC} = 5V$

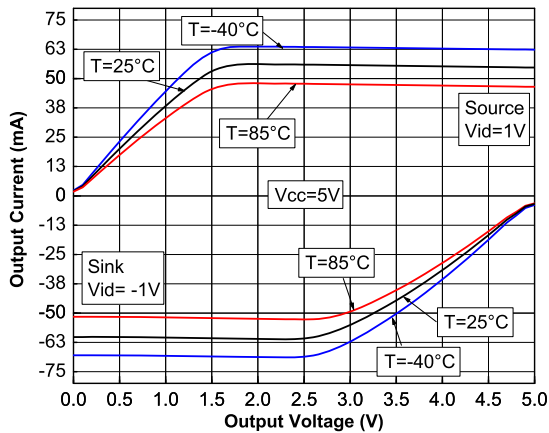

Figure 4. Voltage gain and phase vs. frequency at  $V_{CC} = 1.5V$

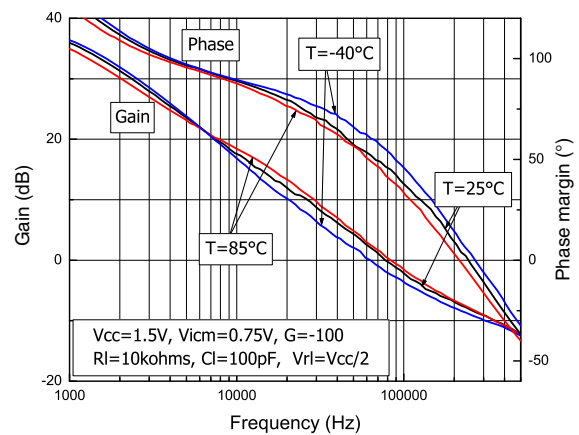

Figure 5. Voltage gain and phase vs. frequency at  $V_{CC} = 5V$

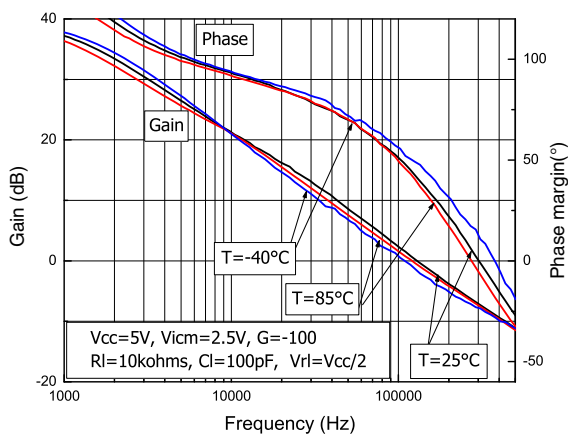
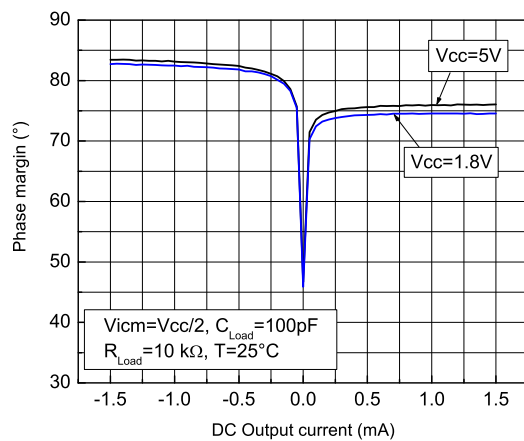

Figure 6. Phase margin vs. output current





Rail-to-rail input/output 10  $\mu$ A, 120 kHz CMOS operational amplifiers

Figure 7. Positive slew rate vs. time,  $V_{CC} = 1.5$  V,  $C_{Load} = 100$  pF,  $R_{Load} = 10$  k $\Omega$

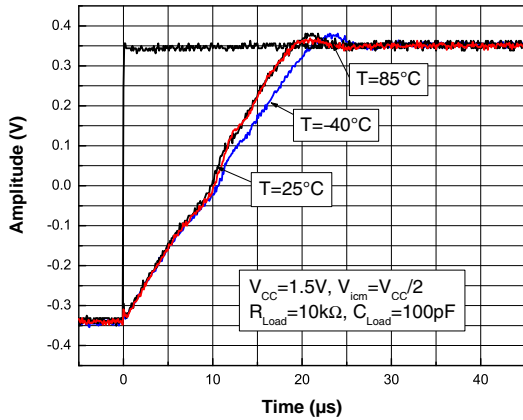

Figure 8. Negative slew rate vs. time,  $V_{CC} = 1.5$  V,  $C_{Load} = 100$  pF,  $R_{Load} = 10$  k $\Omega$

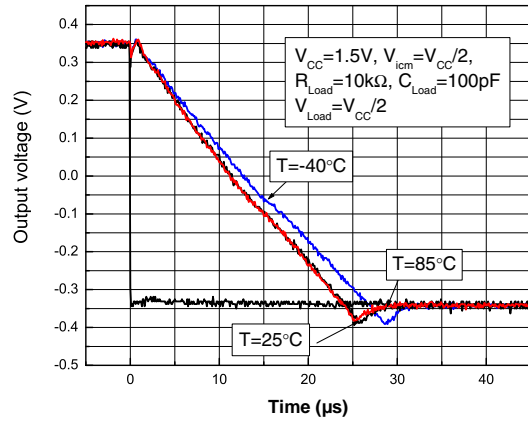

Figure 9. Positive slew rate vs. time,  $V_{CC} = 5.5$  V,  $C_{Load} = 100$  pF,  $R_{Load} = 100$  k $\Omega$

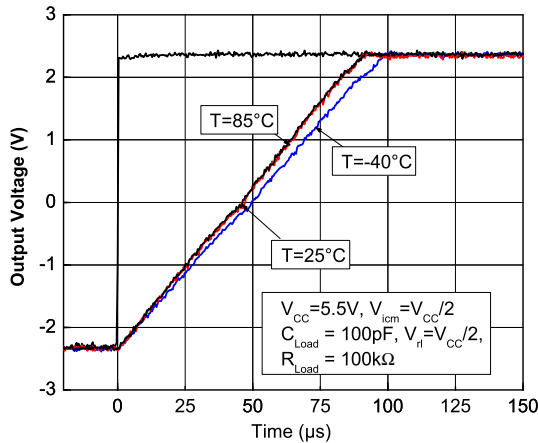

Figure 10. Negative slew rate vs. time,  $V_{CC} = 5.5$  V,  $C_{Load} = 100$  pF,  $R_{Load} = 100$  k $\Omega$

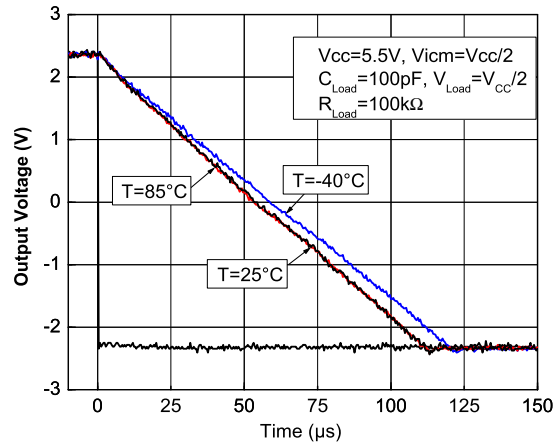

Figure 11. Slew rate vs. supply voltage

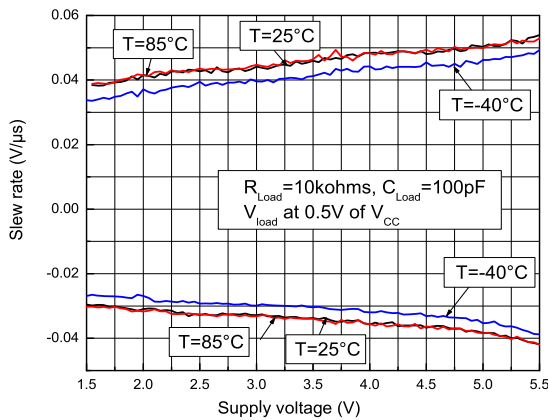

Figure 12. Noise vs. frequency at  $V_{CC} = 5$  V

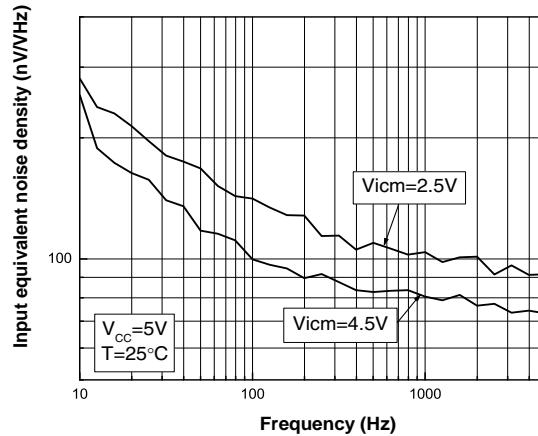

Figure 13. Distortion + noise vs. frequency

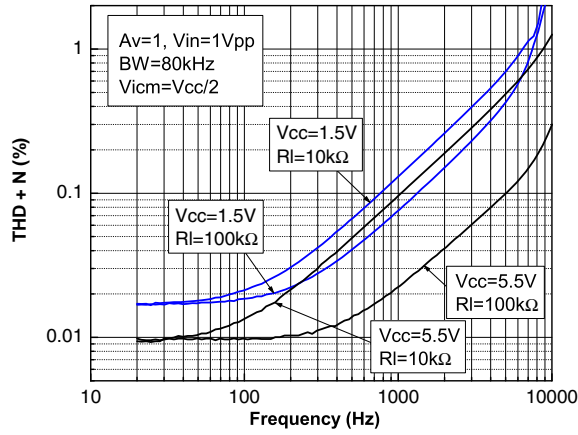

Figure 14. Distortion + noise vs. output voltage

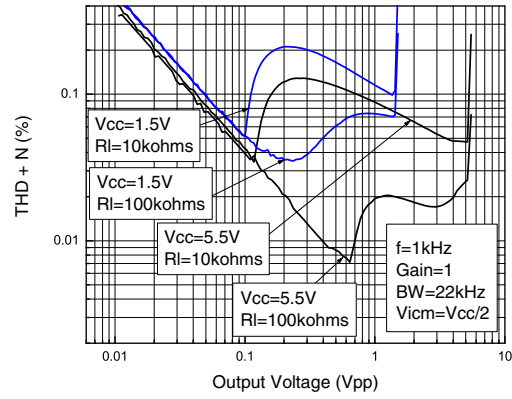

Figure 15. Voltage gain and phase vs. frequency at  $V_{CC} = 1.8$  V (based on simulation results)

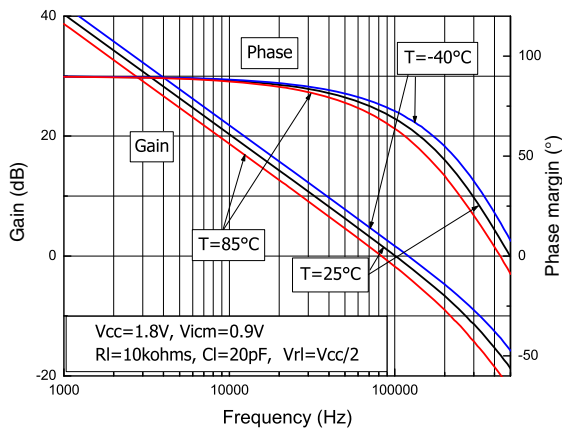

Figure 16. Voltage gain and phase vs. frequency at  $V_{CC} = 5$  V (based on simulation results)

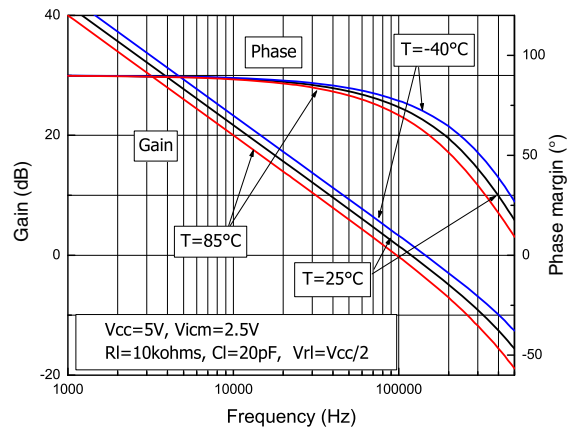
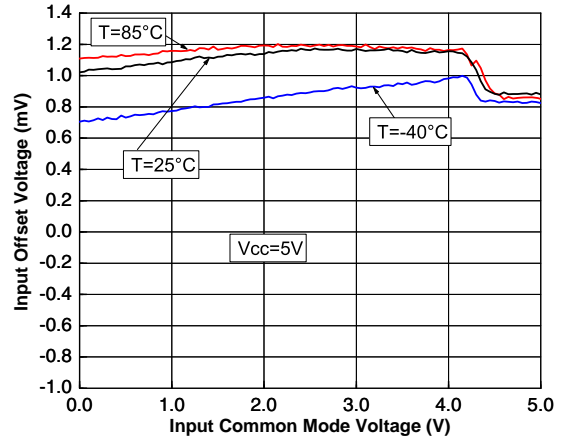
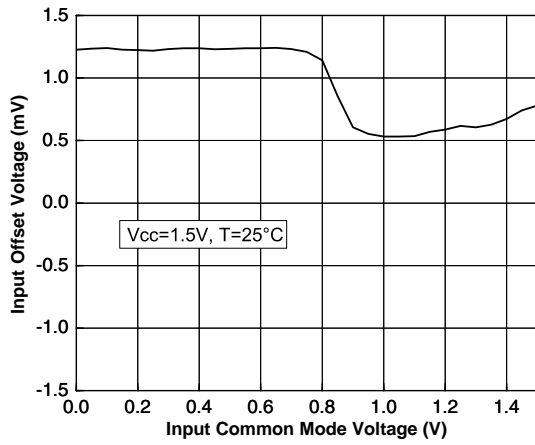

Figure 17. Input offset voltage vs input common mode at  $V_{CC} = 1.5$  V      Figure 18. Input offset voltage vs input common mode at  $V_{CC} = 5$  V



The device is guaranteed without phase reversal.

Package Dimension

SOP-8

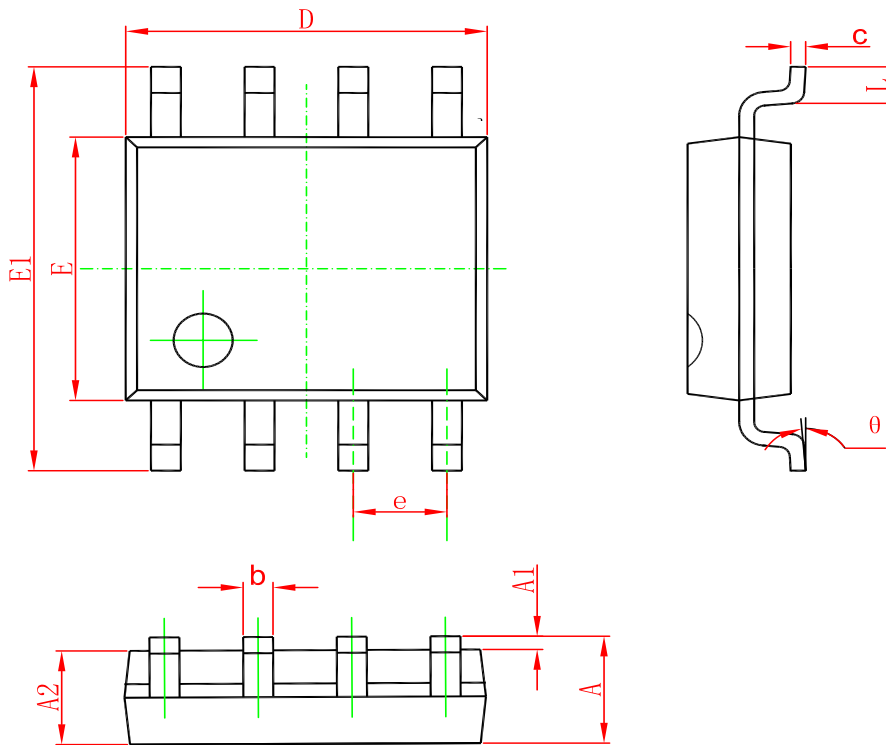

Symbol	Dimensions In Millimeters		Dimensions In Inches	
	Min	Max	Min	Max
A	1.350	1.750	0.053	0.069
A1	0.100	0.250	0.004	0.010
A2	1.350	1.550	0.053	0.061
b	0.330	0.510	0.013	0.020
c	0.170	0.250	0.006	0.010
D	4.700	5.100	0.185	0.200
E	3.800	4.000	0.150	0.157
E1	5.800	6.200	0.228	0.244
e	1.270(BSC)		0.050(BSC)	
L	0.400	1.270	0.016	0.050
$\theta$	0°	8°	0°	8°

SC70-5 (SOT353)

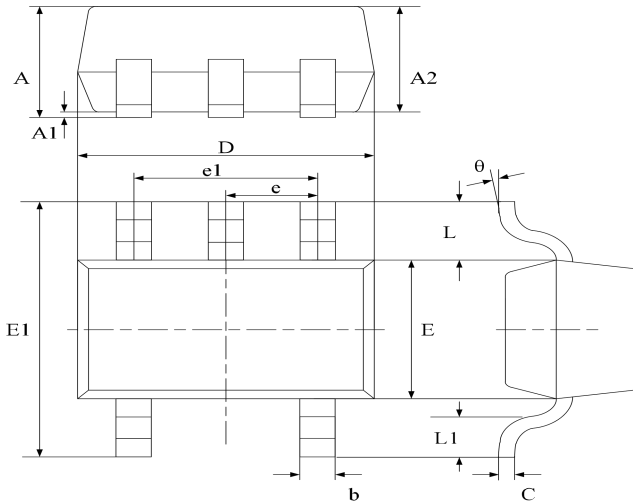

Symbol	Dimensions In Millimeters		Dimensions In Inches	
	Min	Max	Min	Max
A	0.800	1.100	0.035	0.043
A1	0.000	0.100	0.000	0.004
A2	0.800	0.900	0.035	0.039
b	0.150	0.350	0.006	0.014
C	0.080	0.150	0.003	0.006
D	1.8500	2.150	0.079	0.087
E	1.100	1.400	0.045	0.053
E1	1.950	2.200	0.085	0.096
e	0.850 typ.		0.026 typ.	
e1	1.200	1.400	0.047	0.055
L	0.42 ref.		0.021 ref.	
L1	0.260	0.460	0.010	0.018
$\theta$	0°	8°	0°	8°

SOT23-5

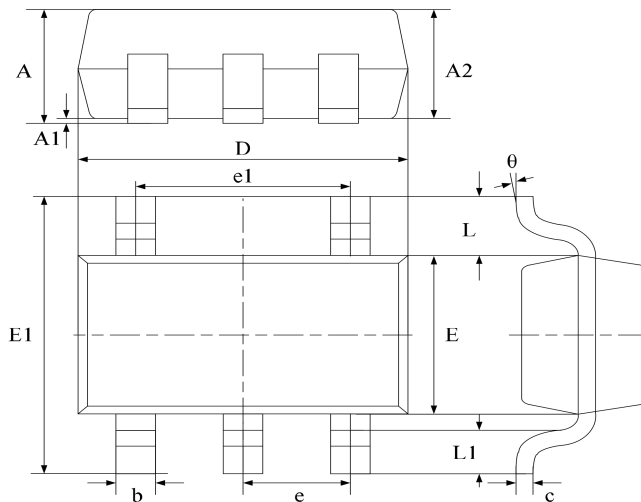

Symbol	Dimensions In Millimeters		Dimensions In Inches	
	Min	Max	Min	Max
A	1.040	1.350	0.042	0.055
A1	0.040	0.150	0.002	0.006
A2	1.000	1.200	0.041	0.049
b	0.380	0.480	0.015	0.020
c	0.110	0.210	0.004	0.009
D	2.720	3.120	0.111	0.127
E	1.400	1.800	0.057	0.073
E1	2.600	3.000	0.106	0.122
e	0.950 typ.		0.037 typ.	
e1	1.900 typ.		0.078 typ.	
L	0.700 ref.		0.028 ref.	
L1	0.300	0.600	0.012	0.024
$\theta$	0°	8°	0°	8°

## Ordering information

Order code	Package	Baseqty	Deliverymode	Marking
UMW TSV611ILT	SOT23-5	3000	Tape and reel	K12 U
UMW TSV611AILT	SOT23-5	3000	Tape and reel	K11 U
UMW TSV611AICT	SC70-5	3000	Tape and reel	K11 U
UMW TSV612IDT	SOP-8	2500	Tape and reel	V612I
UMW TSV612AIDT	SOP-8	2500	Tape and reel	V612AI