

P-Channel Enhancement MOSFET

■ Features

- Ultra low on-resistance.
- Low profile(<1.1mm).
- Available in tape and reel.
- Fast switching.

SOT - 23

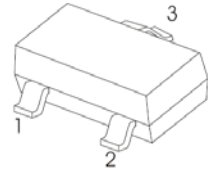

- 1. BASE
- 2. EMITTER
- 3. COLLECTOR

■ Absolute Maximum Ratings Ta = 25°C

Parameter	Symbol	Rating	Unit
Drain-Source Voltage	V <sub>DS</sub>	-20	V
Gate-Source Voltage	V <sub>GS</sub>	±12	
Continuous Drain Current V <sub>GS</sub> =4.5V @ TA=25°C	I <sub>D</sub>	-3.7	A
Continuous Drain Current V <sub>GS</sub> =4.5V@ TA=70°C		-2.2	
Pulsed Drain Current a		I <sub>DM</sub>	
Power Dissipation @ TA=25°C	P <sub>D</sub>	1.3	W
Power Dissipation @ TA=70°C		0.8	
Single Pulse Avalanche Energy b	E <sub>AS</sub>	11	mJ
Thermal Resistance.Junction- to-Ambient	R <sub>thJA</sub>	100	°C/W
Linera Derating Factor		0.01	W/°C
Junction Temperature	T <sub>J</sub>	150	°C
Junction and Storage Temperature Range	T <sub>stg</sub>	-55 to 150	

Notes:

a.Repetitive Rating :Pulse width limited by maximum junction temperature

b.Starting T<sub>J</sub>=25°C, L=1.65mH, R<sub>G</sub>=25Ω, I<sub>AS</sub>=-3.7A

**P-Channel Enhancement MOSFET**
**■ Electrical Characteristics Ta = 25°C**

Parameter	Symbol	Test conditions	Min	Typ	Max	Unit
Drain-source Breakdown voltage	V <sub>DSS</sub>	I <sub>D</sub> = -250 μA, V <sub>GS</sub> = 0V	-20			V
Zero Gate Voltage Drain Current	I <sub>DSS</sub>	V <sub>DS</sub> = -20 V, V <sub>GS</sub> = 0V			-1.0	μA
		V <sub>DS</sub> = -20 V, V <sub>GS</sub> = 0V, T <sub>J</sub> = 70°C			-25	
Gate-source leakage	I <sub>GSS</sub>	V <sub>GS</sub> = ±12V			±100	nA
Gate threshold voltage	V <sub>GS(th)</sub>	V <sub>DS</sub> = V <sub>GS</sub> , I <sub>D</sub> = -250 μA	-0.40	-0.55	-0.95	V
Static drain-source on- resistance	R <sub>DS(on)</sub>	I <sub>D</sub> = -3.7A, V <sub>GS</sub> = -4.5V		0.050	0.065	Ω
		I <sub>D</sub> = -3.1A, V <sub>GS</sub> = -2.5V		0.080	0.135	
Forward Transconductance	g <sub>fs</sub>	V <sub>DS</sub> = -10 V, I <sub>D</sub> = -3.7 A	6.0			S
Input capacitance	C <sub>iss</sub>	V <sub>DS</sub> = -10 V, V <sub>GS</sub> = 0 V, f = 1MHz		633		pF
Output capacitance	C <sub>oss</sub>			145		
Reverse transfer capacitance	C <sub>rss</sub>			110		
Total Gate Charge	Q <sub>g</sub>	V <sub>DS</sub> = -10V, V <sub>GS</sub> = -5.0 V, I <sub>D</sub> = -3.7 A		8.0	12	nC
Gate-Source Charge	Q <sub>gs</sub>			1.2	1.8	
Gate-Drain Charge	Q <sub>gd</sub>			2.8	4.2	
Turn-on delay time	t <sub>d(on)</sub>	I <sub>D</sub> = -3.7 A, V <sub>DD</sub> = -10 V, R <sub>D</sub> = 2.7 Ω R <sub>G</sub> = 89 Ω		350		ns
Rise time	t <sub>r</sub>			48		
Turn-off delay time	t <sub>d(off)</sub>			588		
Fall time	t <sub>f</sub>			381		
Reverse recovery time	t <sub>rr</sub>	T <sub>J</sub> = 25°C, I <sub>F</sub> = -1.0 A, di / dt = -100 A / μs *2		29	43	ns
Reverse recovery charge	Q <sub>rr</sub>			11	17	nC
Continuous source current	I <sub>S</sub>	MOSFET symbol showing the integral reverse p-n junction diode			-1.3	A
Pulsed source current *1	I <sub>SM</sub>				-22	
Diode forward voltage	V <sub>SD</sub>	T <sub>J</sub> = 25°C, V <sub>GS</sub> = 0 V, I <sub>S</sub> = -1.0 A *2			-1.2	V

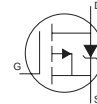

\*1 Repetitive rating; pulse width limited by max. junction temperature.

\* 2 Pulse width ≤ 400 μs, Duty cycle ≤ 2%

■ Typical Characteristics

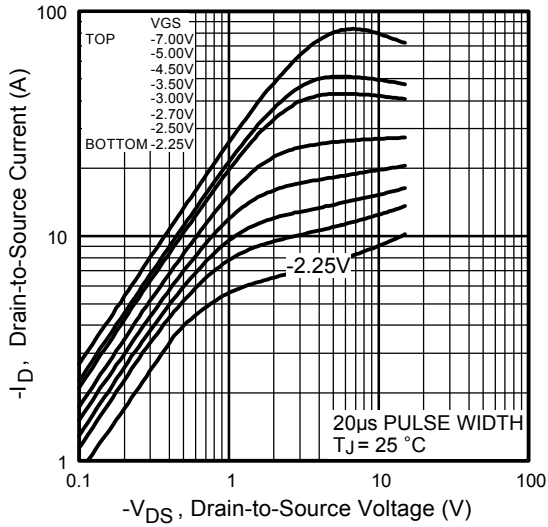

Fig 1. Typical Output Characteristics

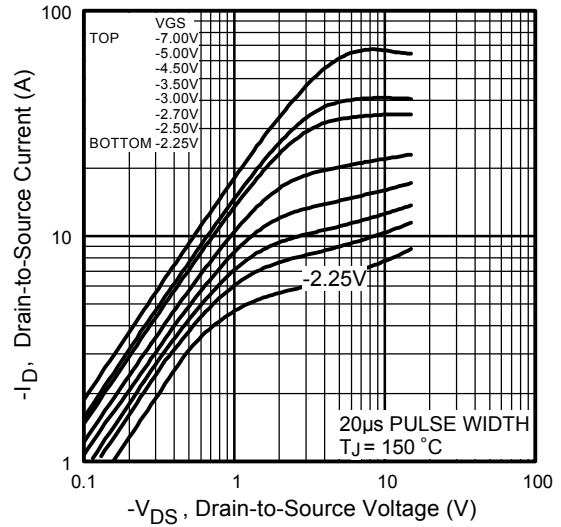

Fig 2. Typical Output Characteristics

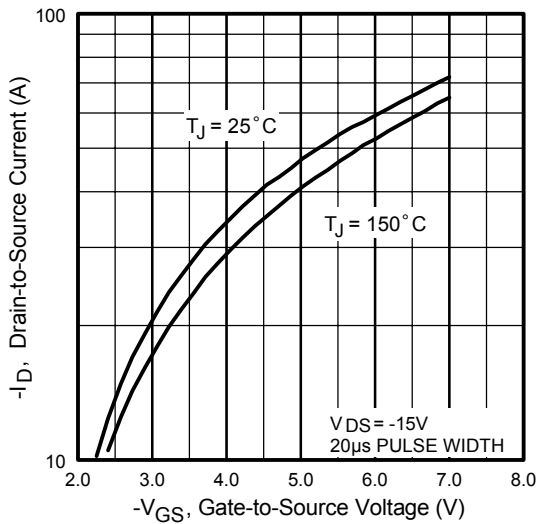

Fig 3. Typical Transfer Characteristics

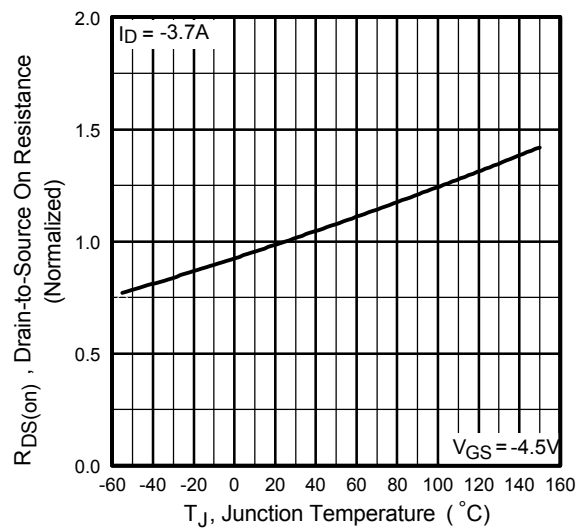
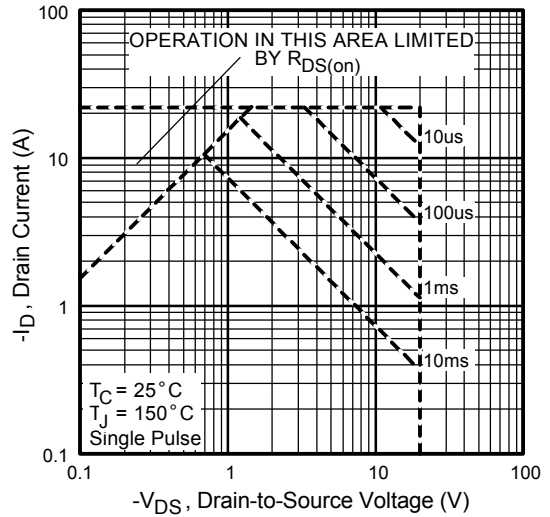
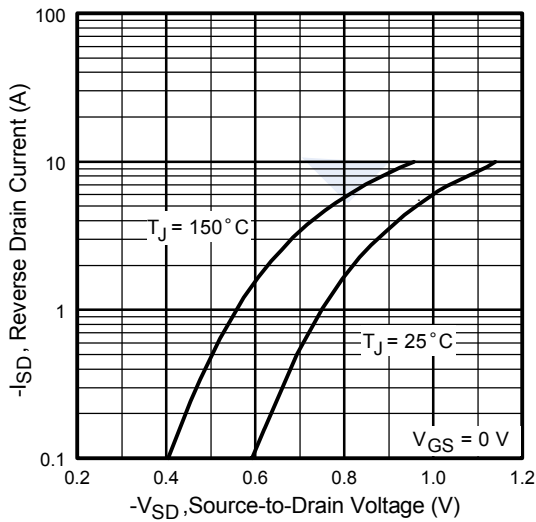
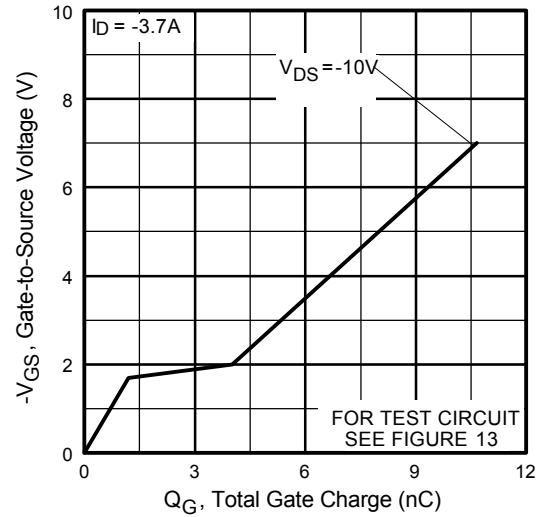
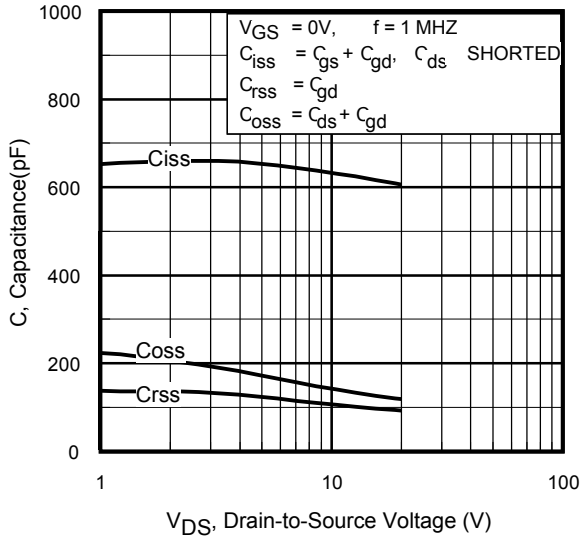

Fig 4. Normalized On-Resistance

■ Typical Characteristics



■ Typical Characteristics

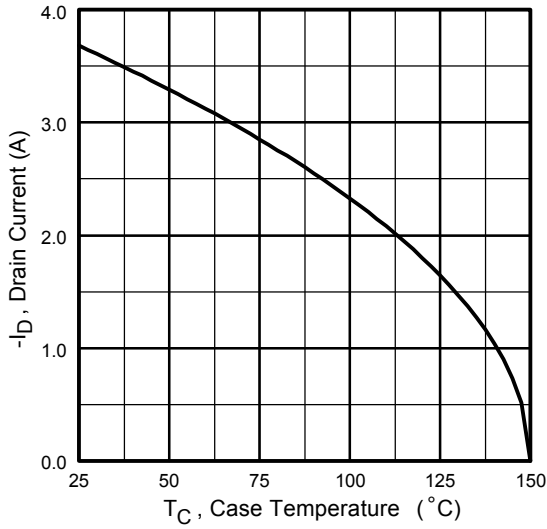

Fig 9. Maximum Drain Current Vs. Case Temperature

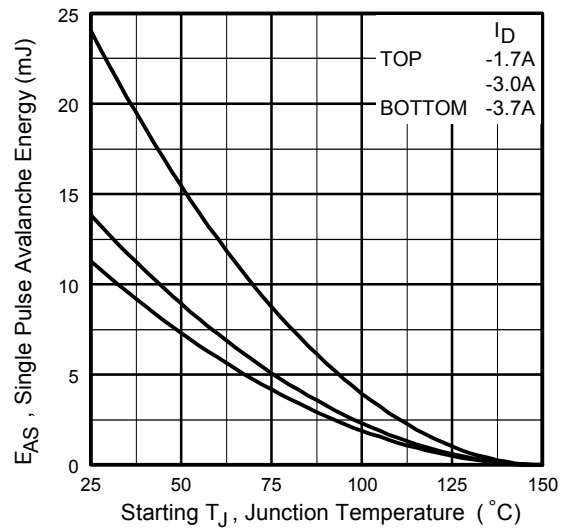

Fig 10. Maximum Avalanche Energy Vs. Drain Current

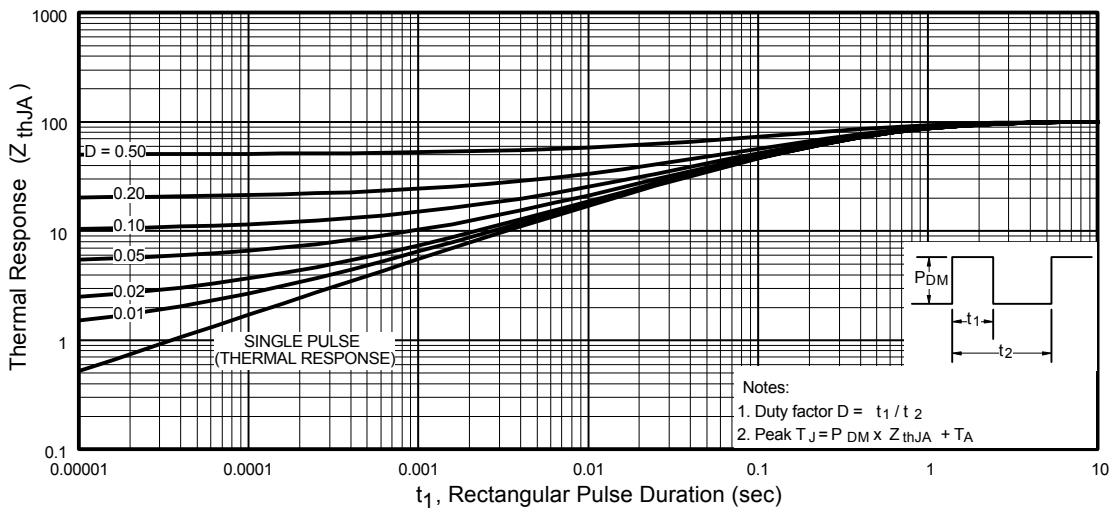

Fig 11. Maximum Effective Transient Thermal Impedance, Junction-to-Ambient

■ Typical Characteristics

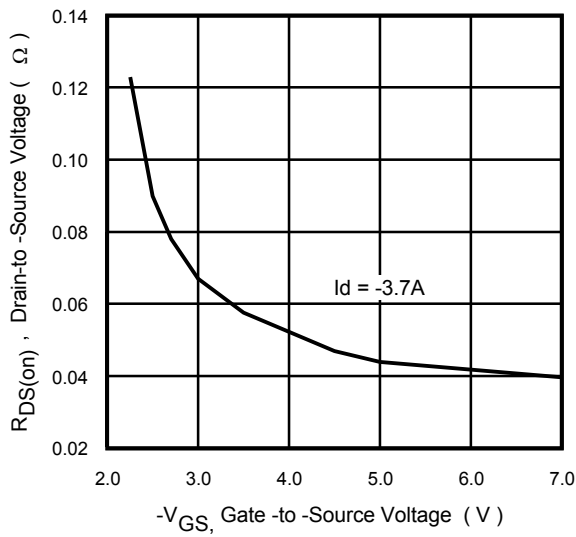

Fig 12. Typical On-Resistance Vs. Gate Voltage

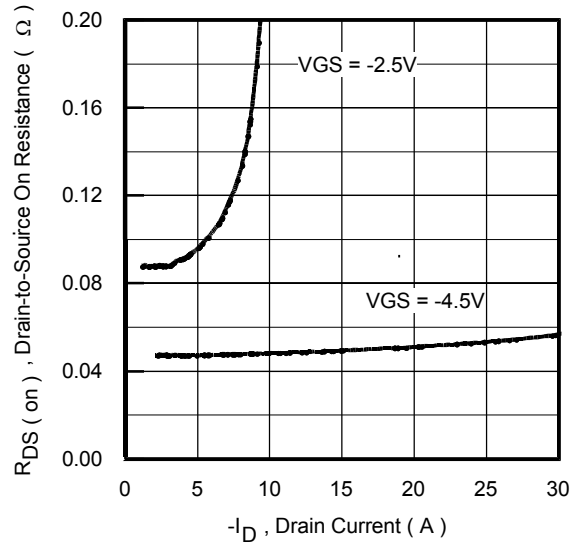
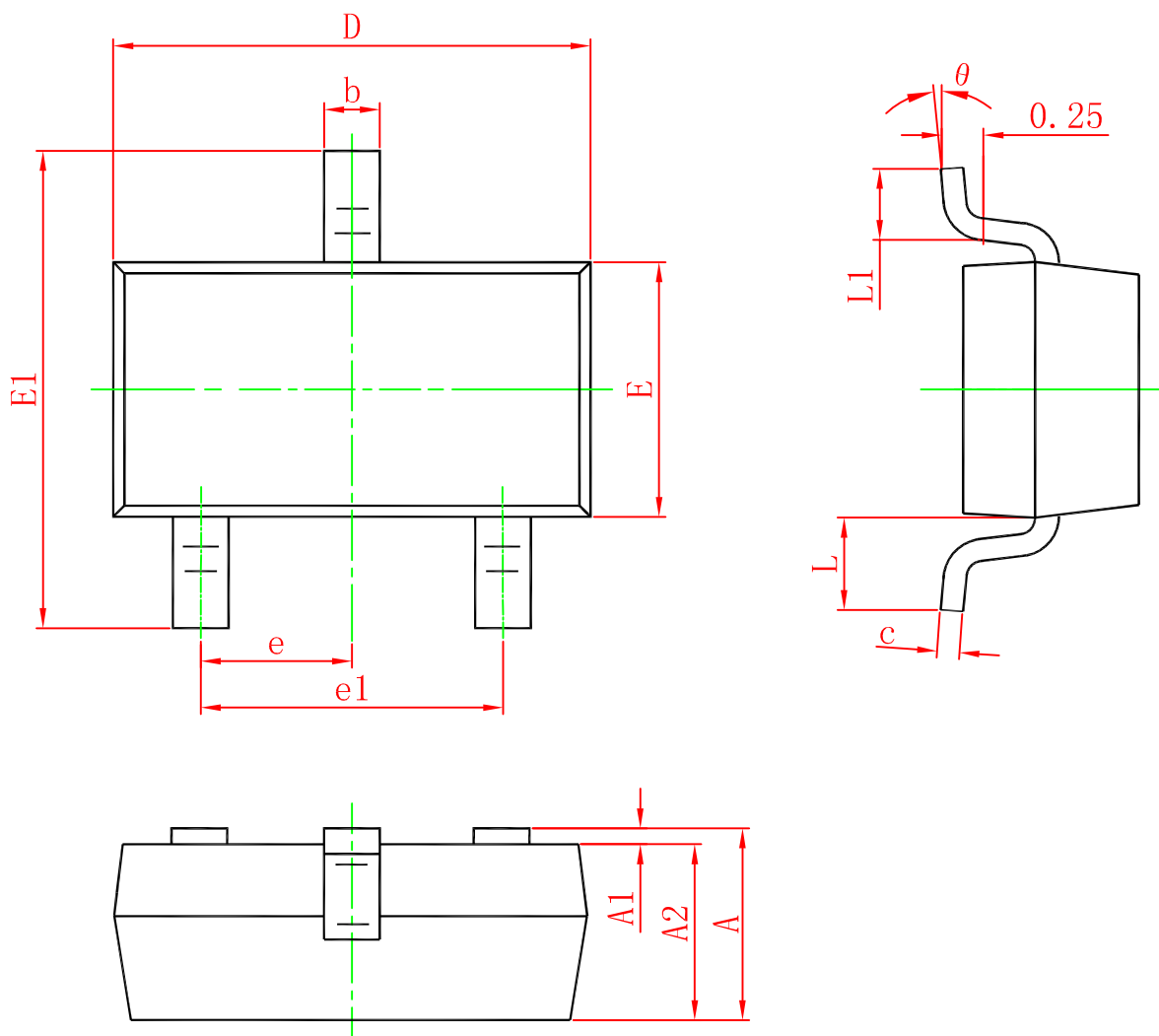

Fig 13. Typical On-Resistance Vs. Drain Current

P-Channel Enhancement MOSFET

SOT-23 PACKAGE OUTLINE DIMENSIONS



Symbol	Dimensions In Millimeters		Dimensions In Inches	
	Min.	Max.	Min.	Max.
A	0.900	1.150	0.035	0.045
A1	0.000	0.100	0.000	0.004
A2	0.900	1.050	0.035	0.041
b	0.300	0.500	0.012	0.020
c	0.080	0.150	0.003	0.006
D	2.800	3.000	0.110	0.118
E	1.200	1.400	0.047	0.055
E1	2.250	2.550	0.089	0.100
e	0.950 TYP.		0.037 TYP.	
e1	1.800	2.000	0.071	0.079
L	0.550 REF.		0.022 REF.	
L1	0.300	0.500	0.012	0.020
θ	0°	8°	0°	8°

Marking

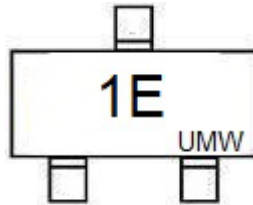

Ordering information

Order code	Package	Baseqty	Deliverymode
UMW IRLML6402TR	SOT-23	3000	Tape and reel