

P-Channel Enhancement MOSFET

■ Features

- Ultra low on-resistance.
- P-Channel MOSFET.
- Fast switching.

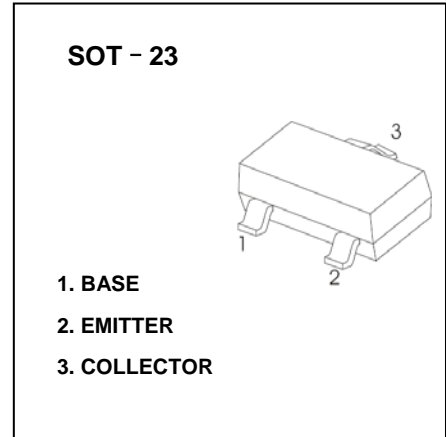

■ Absolute Maximum Ratings Ta = 25°C

Parameter	Symbol	Rating	Unit
Drain-Source Voltage	V <sub>DS</sub>	-12	V
Gate-Source Voltage	V <sub>GS</sub>	±8	
Continuous Drain Current V <sub>GS</sub> =4.5V @ TA=25°C	I <sub>D</sub>	-4.3	A
Continuous Drain Current V <sub>GS</sub> =4.5V @ TA=70°C		-3.4	
Pulsed Drain Current a		I <sub>DM</sub>	
Power Dissipation @ TA=25°C	P <sub>D</sub>	1.3	W
Power Dissipation @ TA=70°C		0.8	
Single Pulse Avalanche Energy b	E <sub>AS</sub>	33	mJ
Thermal Resistance.Junction- to-Ambient	R <sub>thJA</sub>	100	°C/W
Linera Derating Factor		0.01	W/°C
Junction Temperature	T <sub>J</sub>	150	°C
Junction and Storage Temperature Range	T <sub>stg</sub>	-55 to 150	

Notes:

a.Repetitive Rating :Pulse width limited by maximum junction temperature

b.Starting T<sub>J</sub>=25°C, L=3.5mH, R<sub>G</sub>=25Ω, I<sub>AS</sub>=-4.3A

**P-Channel Enhancement MOSFET**
**■ Electrical Characteristics Ta = 25°C**

Parameter	Symbol	Test Conditions	Min	Typ	Max	Unit
Drain-Source Breakdown Voltage	V <sub>DSS</sub>	I <sub>D</sub> =-250 μA, V <sub>GS</sub> =0V	-12			V
Zero Gate Voltage Drain Current	I <sub>DSS</sub>	V <sub>DS</sub> =-12V, V <sub>GS</sub> =0V			-1	μA
		V <sub>DS</sub> =-9.6V, V <sub>GS</sub> =0V, T <sub>J</sub> =55°C			-25	
Gate-Body leakage current	I <sub>GSS</sub>	V <sub>DS</sub> =0V, V <sub>GS</sub> =±8V			±100	nA
Gate Threshold Voltage	V <sub>GS(th)</sub>	V <sub>DS</sub> =V <sub>GS</sub> I <sub>D</sub> =-250 μA	-0.4	-0.55	-0.95	V
Static Drain-Source On-Resistance	R <sub>DS(on)</sub>	V <sub>GS</sub> =-4.5V, I <sub>D</sub> =-4.3A			50	mΩ
		V <sub>GS</sub> =-2.5V, I <sub>D</sub> =-2.5A			85	
		V <sub>GS</sub> =-1.8V, I <sub>D</sub> =-2A			125	
Forward Transconductance	g <sub>FS</sub>	V <sub>DS</sub> =-10V, I <sub>D</sub> =-4.3A	8.6			S
Input Capacitance	C <sub>iss</sub>	V <sub>GS</sub> =0V, V <sub>DS</sub> =-10V, f=1MHz		830		pF
Output Capacitance	C <sub>oss</sub>			180		
Reverse Transfer Capacitance	C <sub>rss</sub>			125		
Total Gate Charge	Q <sub>g</sub>	V <sub>GS</sub> =-5.0V, V <sub>DS</sub> =-10V, I <sub>D</sub> =-4.3A		10	15	nC
Gate Source Charge	Q <sub>gs</sub>			1.4	2.1	
Gate Drain Charge	Q <sub>gd</sub>			2.6	3.9	
Turn-On DelayTime	t <sub>d(on)</sub>	I <sub>D</sub> =-1.0A, V <sub>DS</sub> =-6.0V, R <sub>L</sub> =6 Ω, R <sub>GEN</sub> =89 Ω		11		ns
Turn-On Rise Time	t <sub>r</sub>			32		
Turn-Off DelayTime	t <sub>d(off)</sub>			250		
Turn-Off Fall Time	t <sub>f</sub>			210		
Body Diode Reverse Recovery Time	t <sub>rr</sub>	I <sub>F</sub> =-1.3A, di/dt=-100A/μs		22	33	
Body Diode Reverse Recovery Charge	Q <sub>rr</sub>	I <sub>F</sub> =-1.3A, di/dt=-100A/μs		8	12	Nc
Maximum Body-Diode Continuous Current	I <sub>S</sub>				1.3	A
Diode Forward Voltage	V <sub>SD</sub>	I <sub>S</sub> =-1.3A, V <sub>GS</sub> =0V			-1.2	V

P-Channel Enhancement MOSFET

■ Typical Characteristics

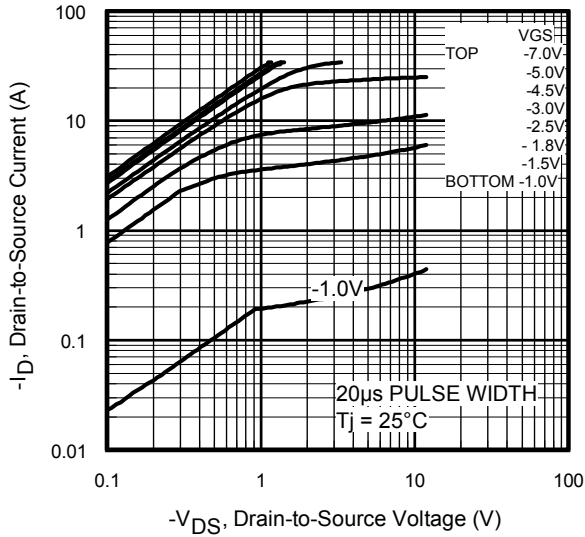

Fig 1. Typical Output Characteristics

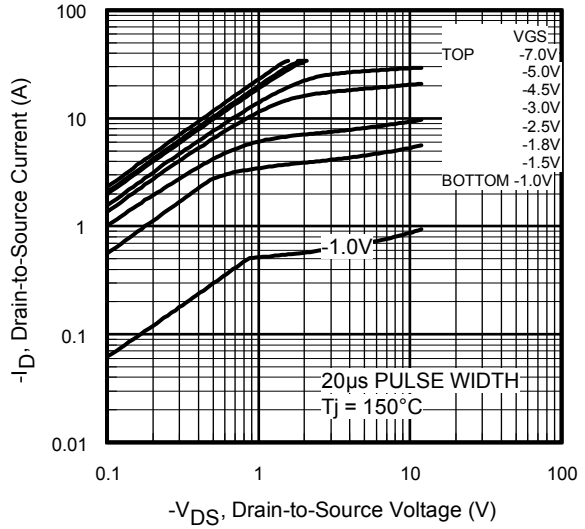

Fig 2. Typical Output Characteristics

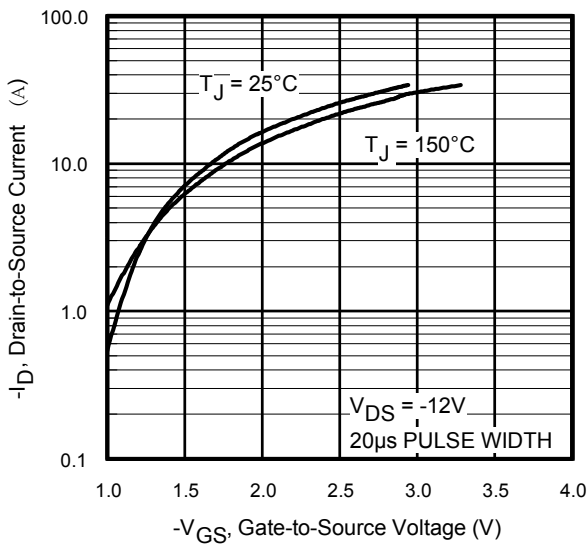

Fig 3. Typical Transfer Characteristics

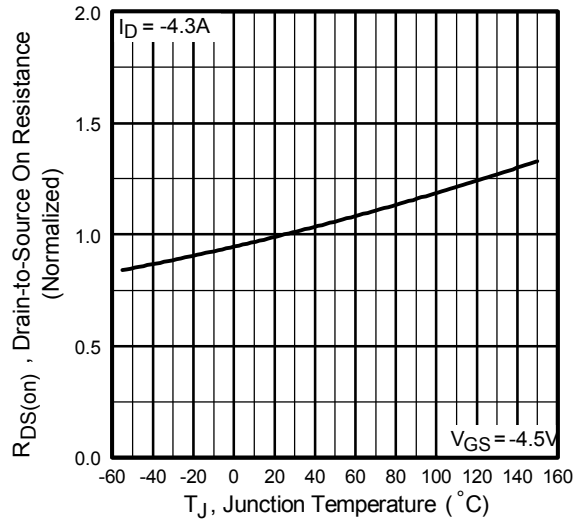

Fig 4. Normalized On-Resistance Vs. Temperature

P-Channel Enhancement MOSFET

■ Typical Characteristics

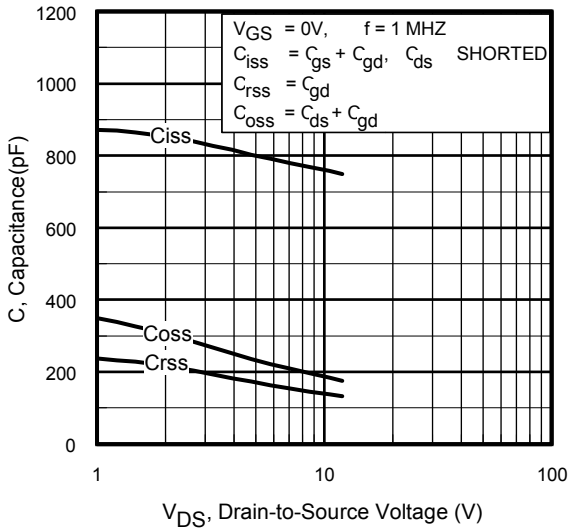

Fig 5. Typical Capacitance Vs. Drain-to-Source Voltage

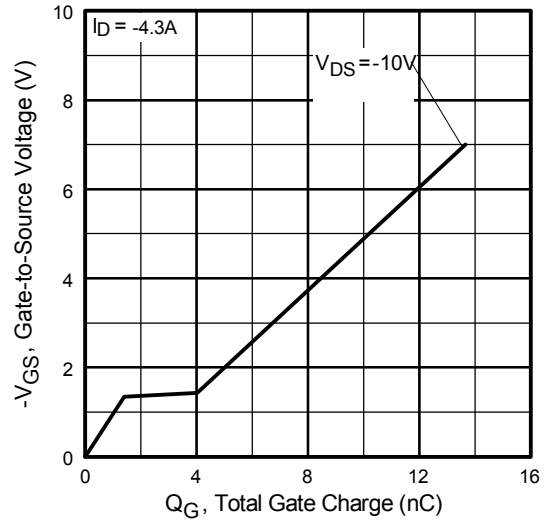

Fig 6. Typical Gate Charge Vs. Gate-to-Source Voltage

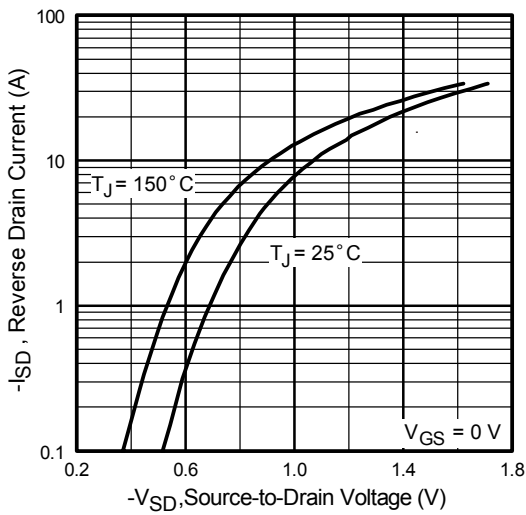

Fig 7. Typical Source-Drain Diode Forward Voltage

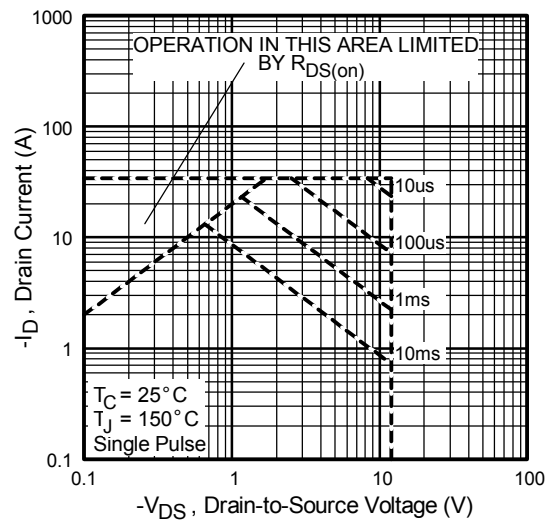

Fig 8. Maximum Safe Operating Area

P-Channel Enhancement MOSFET

■ Typical Characteristics

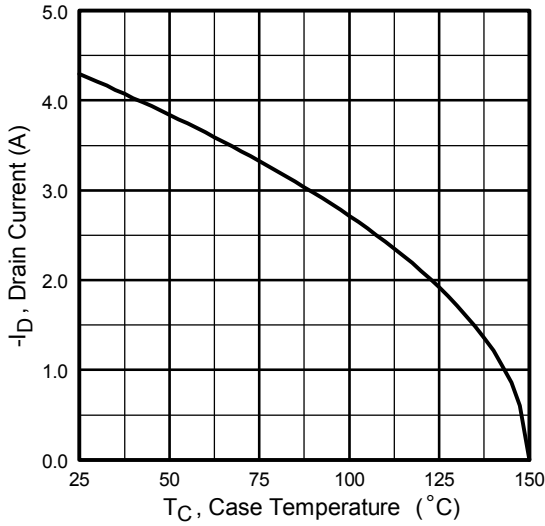

Fig 9. Maximum Drain Current Vs. Case Temperature

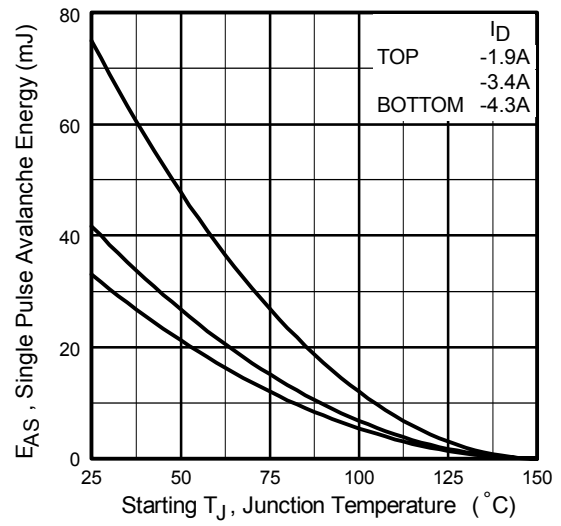

Fig 10. Maximum Avalanche Energy Vs. Drain Current

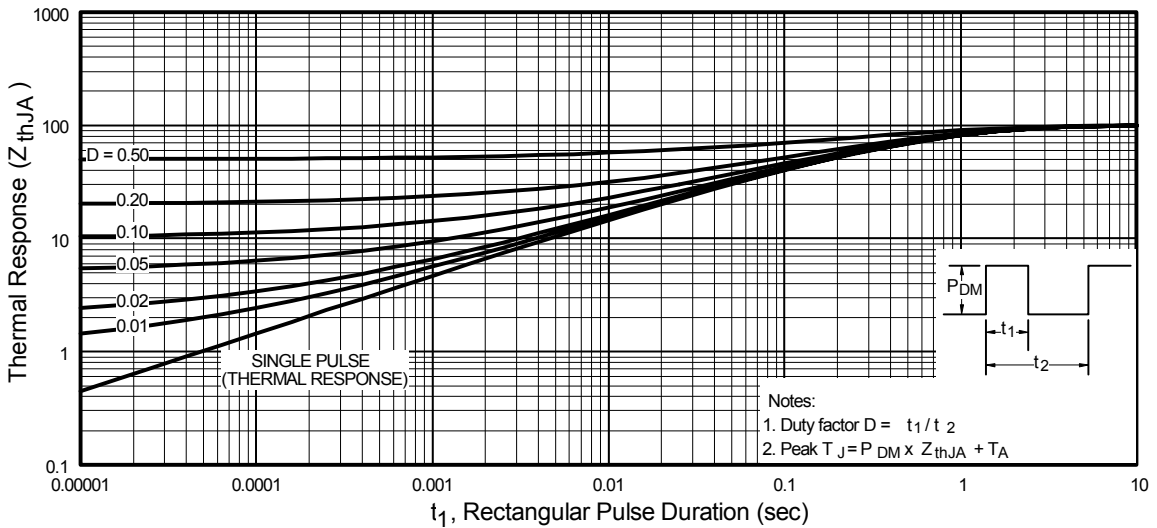

Fig 11. Maximum Effective Transient Thermal Impedance, Junction-to-Ambient

P-Channel Enhancement MOSFET

■ Typical Characteristics

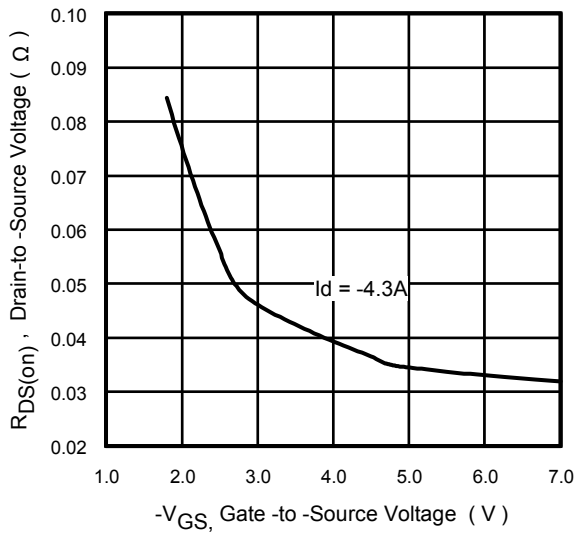

Fig 12. Typical On-Resistance Vs. Gate Voltage

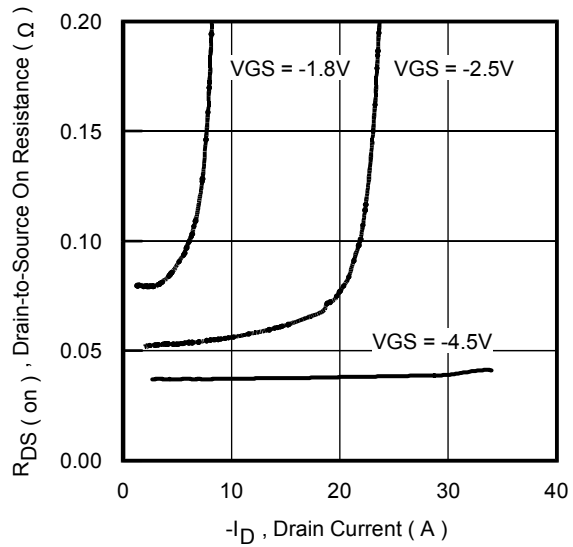

Fig 13. Typical On-Resistance Vs. Drain Current

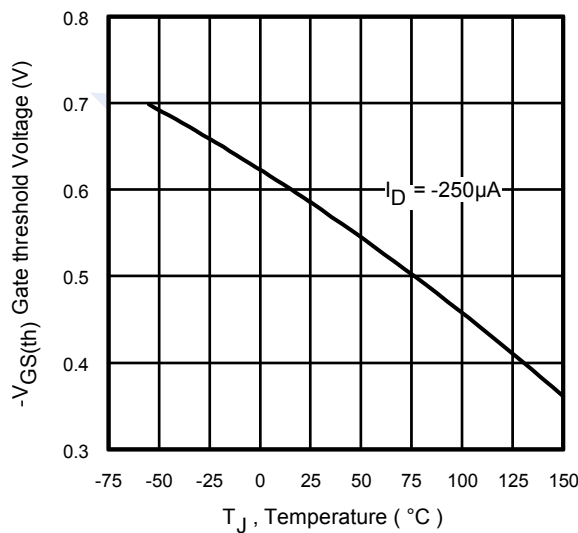
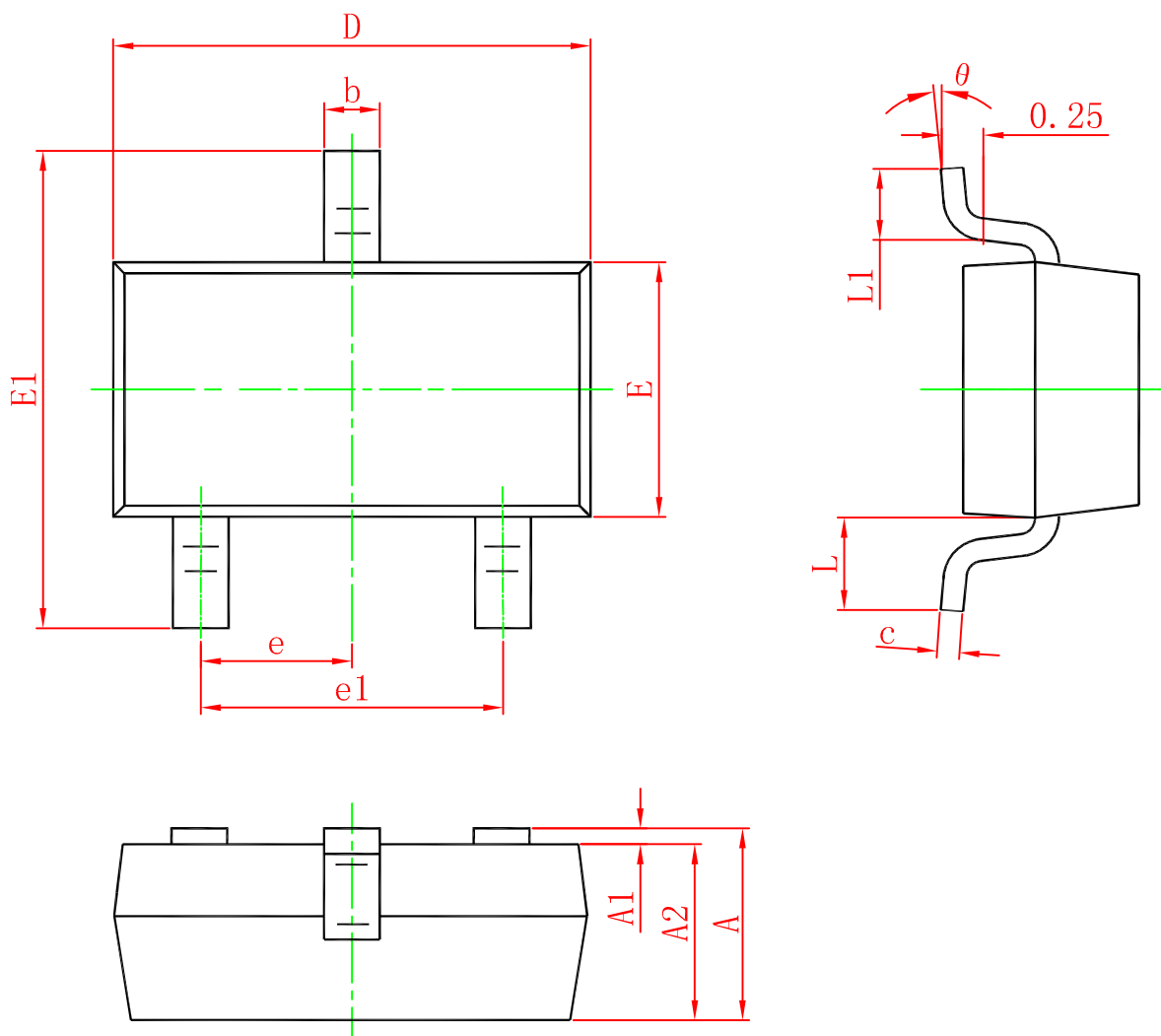

Fig 14. Typical Threshold Voltage Vs. Junction Temperature

P-Channel Enhancement MOSFET

SOT-23 PACKAGE OUTLINE DIMENSIONS



Symbol	Dimensions In Millimeters		Dimensions In Inches	
	Min.	Max.	Min.	Max.
A	0.900	1.150	0.035	0.045
A1	0.000	0.100	0.000	0.004
A2	0.900	1.050	0.035	0.041
b	0.300	0.500	0.012	0.020
c	0.080	0.150	0.003	0.006
D	2.800	3.000	0.110	0.118
E	1.200	1.400	0.047	0.055
E1	2.250	2.550	0.089	0.100
e	0.950 TYP.		0.037 TYP.	
e1	1.800	2.000	0.071	0.079
L	0.550 REF.		0.022 REF.	
L1	0.300	0.500	0.012	0.020
theta	0°	8°	0°	8°

Marking

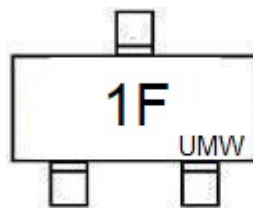

Ordering information

Order code	Package	Baseqty	Deliverymode
UMW IRLML6401TR	SOT-23	3000	Tape and reel