

Metal Oxide Varistor Leaded Disk Type, 5~25mm

MVR Series

MERITEK

FEATURE

- Operating / Storage Temperature: -40°C ~ +105°C / -40°C +125°C
- Varistor Voltage: 18V to 1800V
- Withstanding Surge Current Rating Up to 15KA
- Various Lead Form and Spacing Options
- UL/cUL Safety Approved: Certification No: E326004
- VDE Safety Approved: Certification No: 40013638



PART NUMBERING SYSTEM

MVR 14 D 911 K O
(1) (2) (3) (4) (5) (6)



No	Item	Digit	Description	Series Reference
(1)	Meritek Series	MVR	Metal Oxide Varistor	Leaded Type
(2)	Diameter	14	14: $\phi 14\text{mm}$	5, 7, 10, 14, 20, 25
(3)	Lead/Package Type	D	D: Round Disk or Dual Square Disk	S: Single Square, A: Bare
(4)	Voltage	911	911: 910VDC	18V~1800V
(5)	Tolerance	K	K: $\pm 10\%$	-10% ~ +10%
(6)	Lead Type	O	O: Out kink	Blank: Straight, Y: Y Kink, O: Out Kink,

ELECTRICAL CHARACTERISTICS AND DIMENSIONS REFERENCE TABLE

MVR Series	Varistor DC Voltage @1mA	Maximun Energy (10/1K μ s)	D	H	H1	L min	L1 min	d	d1 ± 0.4	F
MVR05	18V~750V	0.4J~16.0J	5.0~7.5	5.5~10.0	8.0~13.0	20.0	15.0	0.6 ± 0.05	1.2	5.0 ± 0.8
MVR07	18V~820V	0.9~33.0J	7.0~9.0	7.5~12.0	9.0~13.5	20.0	15.0	0.6 ± 0.05	1.2	5.0 ± 0.8
MVR10	18V~1.1kV	2.1~115.0J	10.0~12.5	10.5~16.0	13.0~17.5	20.0	15.0	0.8 ± 0.05	1.4	7.5 ± 0.8
MVR14	18V~1.8kV	4.0~213.0J	14.0~16.5	14.5~20.0	17.0~21.0	20.0	15.0	0.8 ± 0.05	1.4	7.5 ± 0.8
MVR20	18V~1.8kV	11.0J~383J	20.0~23.0	21.0~26.0	24.0~28.0	20.0	15.0	0.8 ± 0.05	1.4	7.5 ± 0.8
								1.0 ± 0.05	1.6	10.0 ± 1.0
MVR25	18V~1.8kV	190J~770J	25.0~28.0	27.0~31.5	-	20.0	-	1.0 ± 0.1	-	10.0 ± 1.0
										12.5 ± 1.0

(Unit: mm)

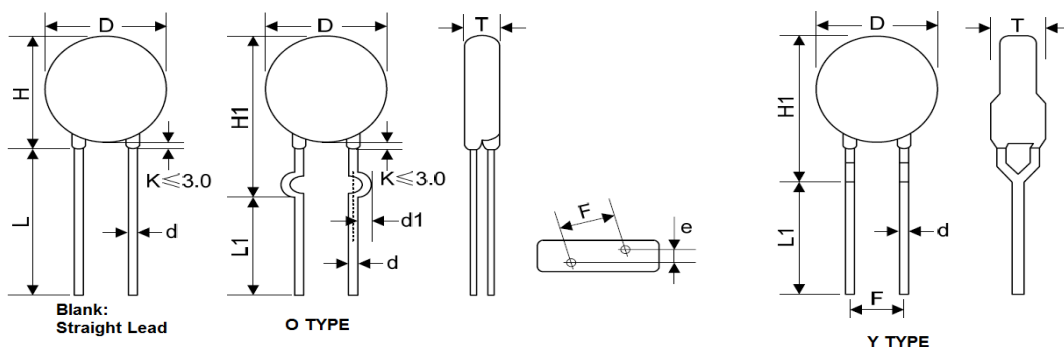

Metal Oxide Varistor Leaded Disk Type, 5~25mm

MVR Series

MERITEK

ELECTRICAL CHARACTERISTICS – MVR05D SERIES

[Back to Top](#)

MVR05D Series	Varistor DC Voltage @1mA		Max. Allowable Voltage		Max. Clamping Voltage		Withstanding Surge Current (A)	Max. Energy (10/1Kµs) (J)	Rated Power (W)	Typical Cap. @1kHz (pF)	Dimension	
	V _{DC}	V _{AC}	V _{DC}	V _c	I _p	T _{max}					e ±0.8	
	(V)	(V _{rms})	(V)	(V)	(A)							
MVR05D180K	18(15~21.6)	11	14	40	1	100	0.01	0.4	0.01	1,400	4.5	1.3
MVR05D220K	22(19.5~26)	14	18	48				0.5		1,150	4.6	1.4
MVR05D270K	27(24~31)	17	22	60				0.6		930	4.7	1.6
MVR05D330K	33(29.5~36.5)	20	26	73				0.8		760	4.9	1.5
MVR05D390K	39(35~43)	25	31	80				0.9		640	4.8	1.6
MVR05D470K	47(42~52)	30	38	104				1.1		530	4.9	1.7
MVR05D560K	56(50~62)	35	45	123				1.3		450	5.0	1.9
MVR05D680K	68(61~75)	40	56	145				1.6		370	5.2	2.2
MVR05D820K	82(74~90)	50	65	150				2.5		300	4.1	1.6
MVR05D101K	100(90~110)	60	85	177	5	400	0.10	3.0	250	4.3	1.8	
MVR05D121K	120(108~132)	75	100	210				4.0	210	4.5	2.0	
MVR05D151K	150(135~165)	95	125	260				4.1	165	4.8	1.6	
MVR05D181K	180(162~198)	115	150	320				4.9	140	4.3	1.7	
MVR05D201K	200(180~220)	130	170	355				6.5	125	4.4	1.8	
MVR05D221K	220(198~242)	140	180	380				7.5	110	4.5	1.9	
MVR05D241K	240(216~264)	150	200	415				8.0	100	4.6	2.0	
MVR05D271K	270(243~297)	175	225	475				8.5	95	4.9	2.2	
MVR05D301K	300(270~330)	190	250	520				9.0	85	5.0	2.3	
MVR05D331K	330(297~363)	210	275	570				9.5	75	5.1	2.3	
MVR05D361K	360(324~396)	230	300	620				10.0	70	5.2	2.5	
MVR05D391K	390(351~429)	250	320	675				12.0	65	5.4	2.6	
MVR05D431K	430(387~473)	275	350	745				13.0	60	5.7	2.8	
MVR05D471K	470(423~517)	300	385	810				15.0	55	6.0	3.0	
MVR05D511K	510(459~561)	320	415	845				16.0	50	6.2	3.2	
MVR05D561K	560(504~616)	350	460	920				16.0	45	6.5	3.4	
MVR05D621K	620(558~682)	385	505	1025	21.0	40	6.5	3.7				
MVR05D681K	680(612~748)	420	560	1120	21.0	35	6.8	4.0				
MVR05D751K	750(675~825)	460	615	1240	22.4	30	6.9	4.1				

Notes:

- The tolerance of varistor voltage between 18V and 27V is more than 10%.
- Leakage Current (@83% of V_{1mA}) : IR≤50µA (180K~680K) IR≤25µA (820K~751K)

Metal Oxide Varistor Leaded Disk Type, 5~25mm

MVR Series

MERITEK

SURGE CURRENT DERATING CURVES – MVR05D SERIES

[Back to Top](#)

MVR05D180K ~ MVR05D680K

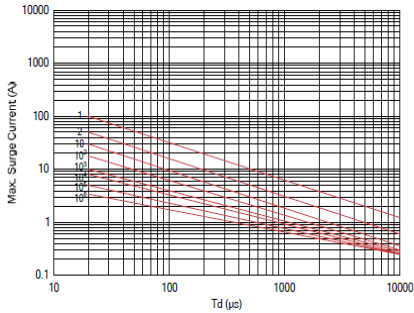

MVR05D820K ~ MVR05D751K

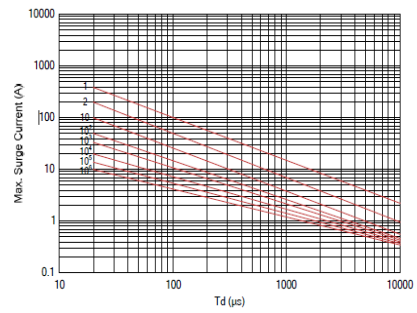

LEAKAGE CURRENT & CLAMPING VOLTAGE CURVES – MVR05D SERIES

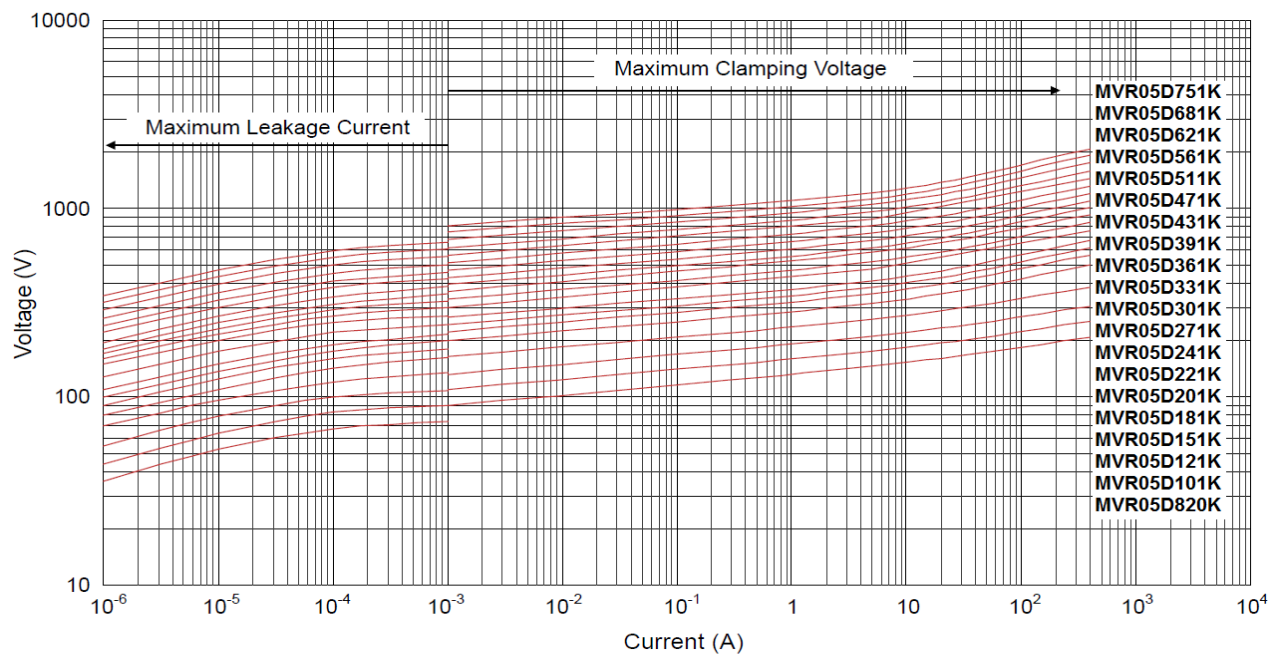
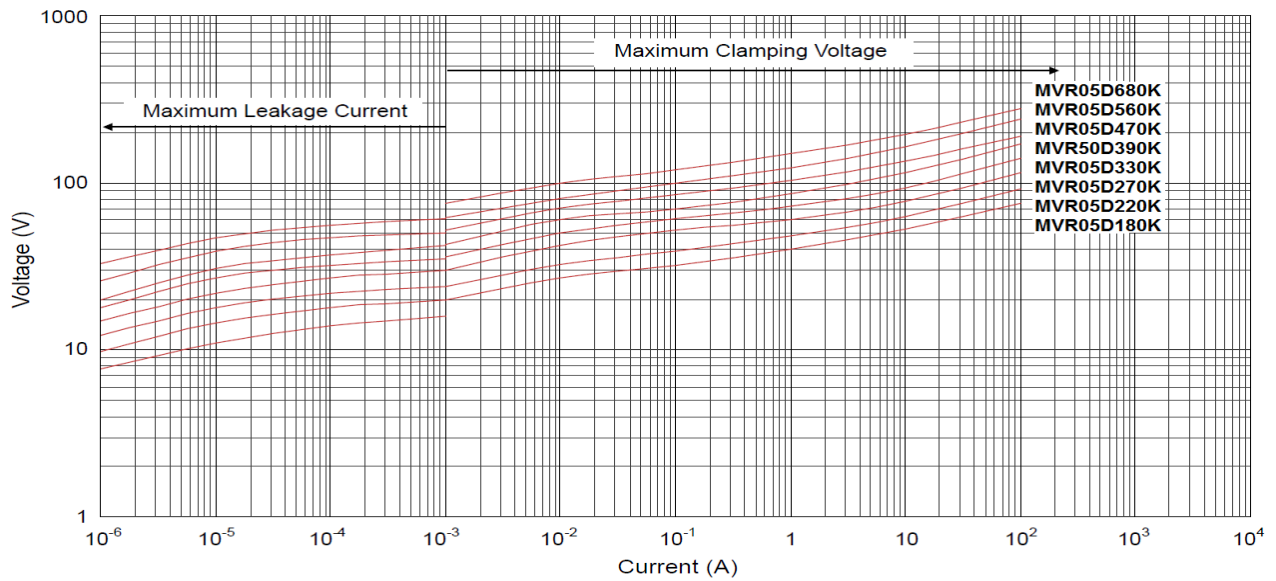

Metal Oxide Varistor Leaded Disk Type, 5~25mm

MVR Series

MERITEK

ELECTRICAL CHARACTERISTICS - MVR07D SERIES

[Back to Top](#)

MVR07D Series	Varistor DC Voltage @1mA		Max. Allowable Voltage		Max. Clamping Voltage		Withstanding Surge Current (A)	Max. Energy (10/1K μ s) (J)	Rated Power (W)	Typical Cap. @1kHz (pF)	Dimension	
	V _{DC}	V _{AC}	V _{DC}	V _c	I _p	T _{max}					e \pm 0.8	
	(V)	(V _{rms})	(V)	(V)	(A)							
MVR07D180K	18(15~21.6)	11	14	36	2.5	250	0.02	0.9	2800	4.5	1.3	
MVR07D220K	22(19.5~26)	14	18	43				1.1	2300	4.6	1.4	
MVR07D270K	27(24~31)	17	22	53				1.4	1800	4.7	1.6	
MVR07D330K	33(29.5~36.5)	20	26	65				1.7	1500	4.9	1.5	
MVR07D390K	39(35~43)	25	31	77				2.1	1300	4.8	1.6	
MVR07D470K	47(42~52)	30	38	93				2.5	1100	4.9	1.7	
MVR07D560K	56(50~62)	35	45	110				3.1	890	5.0	1.9	
MVR07D680K	68(61~75)	40	56	135				3.6	740	5.2	2.2	
MVR07D820K	82(74~90)	50	65	135	10	1,200	0.25	5.0	600	4.1	1.6	
MVR07D101K	100(90~110)	60	85	165				6.5	500	4.3	1.8	
MVR07D121K	120(108~132)	75	100	200				7.8	420	4.5	2.0	
MVR07D151K	150(135~165)	95	125	250				9.7	330	4.8	1.6	
MVR07D181K	180(162~198)	115	150	300				11.7	280	4.3	1.7	
MVR07D201K	200(180~220)	130	170	340				13.0	250	4.4	1.8	
MVR07D221K	220(198~242)	140	180	360				14.0	230	4.5	1.9	
MVR07D241K	240(216~264)	150	200	395				15.0	210	4.6	2.0	
MVR07D271K	270(243~297)	175	225	455				18.0	185	4.9	2.2	
MVR07D301K	300(270~330)	190	250	500				20.0	165	5.0	2.3	
MVR07D331K	330(297~363)	210	275	550				23.0	150	5.1	2.3	
MVR07D361K	360(324~396)	230	300	595				25.0	140	5.2	2.5	
MVR07D391K	390(351~429)	250	320	650				25.0	130	5.4	2.6	
MVR07D431K	430(387~473)	275	350	710				28.0	115	5.7	2.8	
MVR07D471K	470(423~517)	300	385	775				30.0	105	6.0	3.0	
MVR07D511K	510(459~561)	320	415	845				30.0	100	6.2	3.2	
MVR07D561K	560(504~616)	350	460	925				30.0	90	6.5	3.4	
MVR07D621K	620(558~682)	385	505	1025				33.0	80	7.1	3.7	
MVR07D681K	680(612~748)	420	560	1120				33.0	75	7.3	4.0	
MVR07D751K	750(675~825)	460	615	1240				67.2	70	7.0	4.1	
MVR07D781K	780(702~858)	485	640	1290	67.2	70	7.2	4.2				
MVR07D821K	820(738~902)	510	670	1355	67.2	60	7.5	4.4				

Notes:

- The tolerance of varistor voltage between 18V and 27V is more than 10%.
- Leakage Current (@83% of V_{1mA}) : IR \leq 50 μ A (180K~680K) IR \leq 25 μ A (820K~821K)

Metal Oxide Varistor Leaded Disk Type, 5~25mm

MVR Series

MERITEK

SURGE CURRENT DERATING CURVES – MVR07D SERIES

[Back to Top](#)

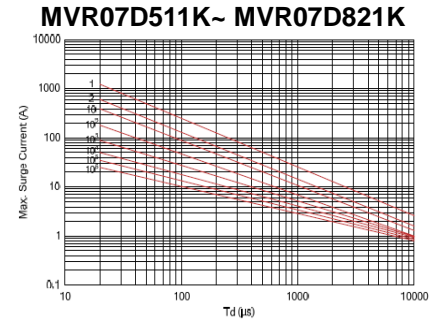
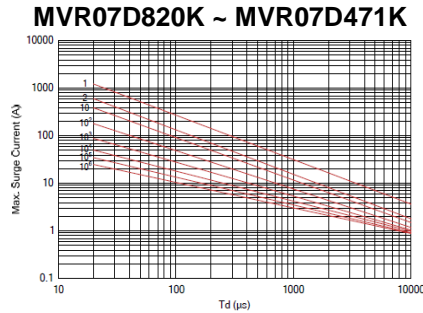
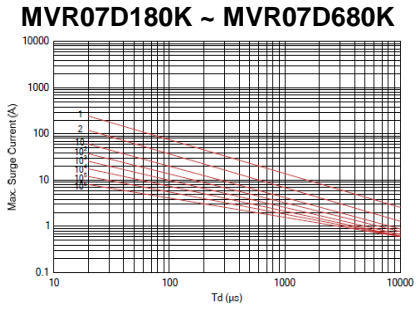

LEAKAGE CURRENT & CLAMPING VOLTAGE CURVES – MVR07D SERIES

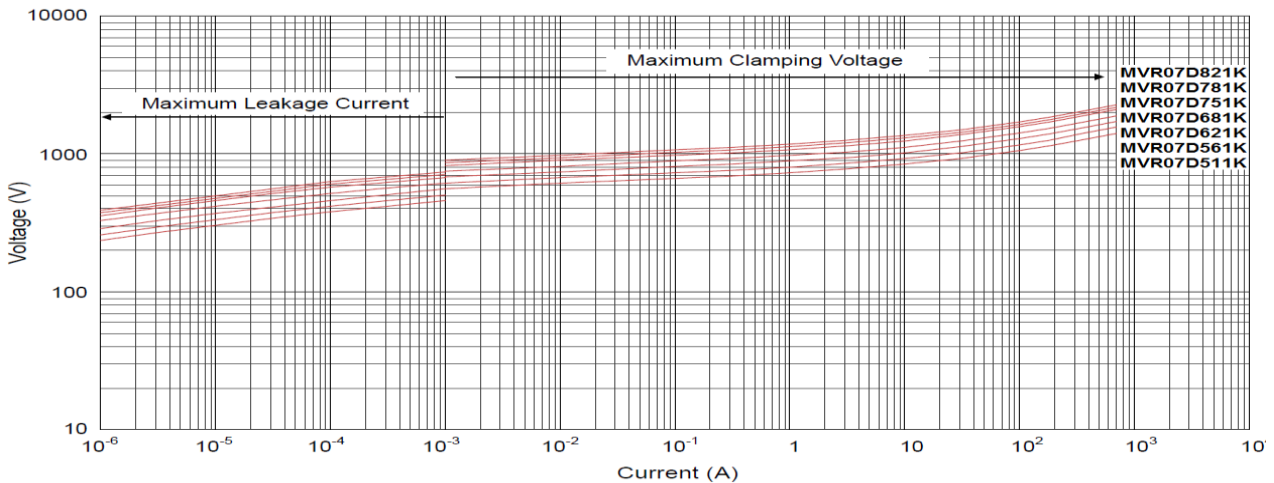
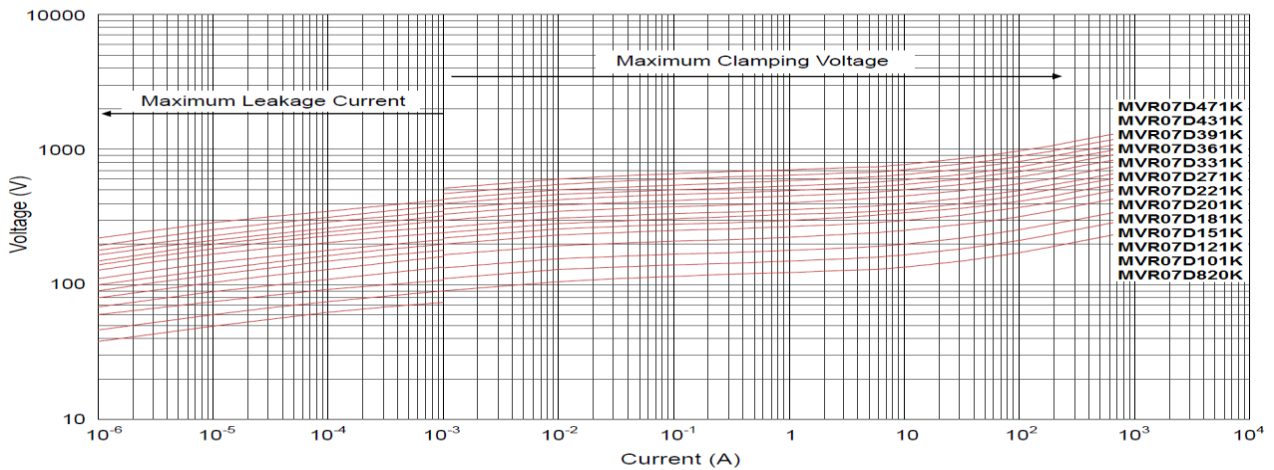
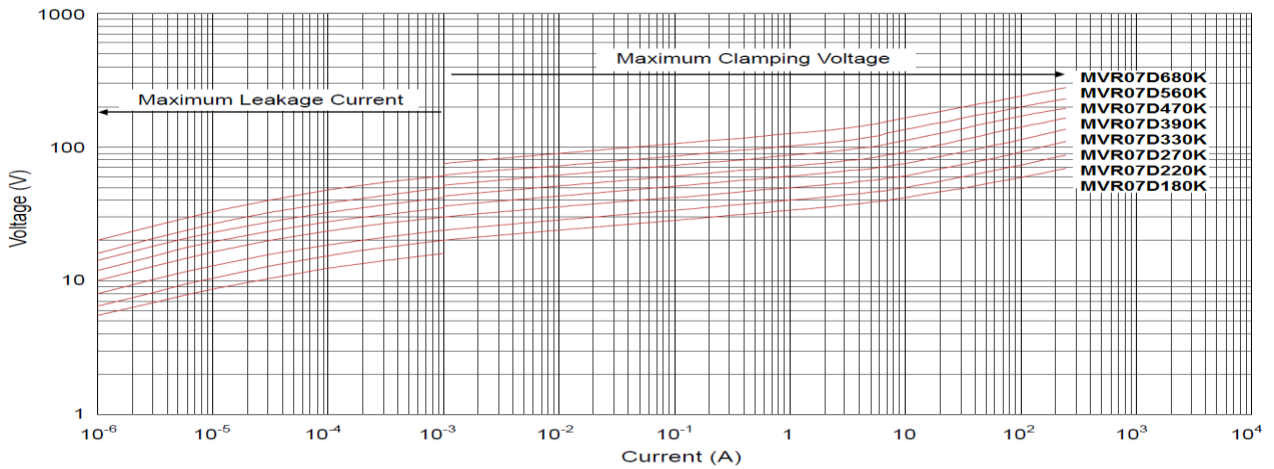

Metal Oxide Varistor Leaded Disk Type, 5~25mm

MVR Series

MERITEK

ELECTRICAL CHARACTERISTICS - MVR10D SERIES

[Back to Top](#)

MVR10D Series	Varistor DC Voltage @1mA		Max. Allowable Voltage		Max. Clamping Voltage		Withstanding Surge Current (A)	Max. Energy (10/1Kµs) (J)	Rated Power (W)	Typical Cap. @1kHz (pF)	Dimension	
	V _{DC}	V _{AC}	V _{DC}	V _c	I _p	T _{max}					e ±0.8	
	(V)	(V _{rms})	(V)	(V)	(A)							
MVR10D180K	18(15~21.6)	11	14	36	5	500	2.1	0.05	5600	4.6	1.5	
MVR10D220K	22(19.5~26)	14	18	43			2.5		4500	4.7	1.6	
MVR10D270K	27(24~31)	17	22	53			3.0		3700	4.8	1.8	
MVR10D330K	33(29.5~36.5)	20	26	65			4.0		3000	5.0	1.7	
MVR10D390K	39(35~43)	25	31	77			4.6		2400	5.3	1.8	
MVR10D470K	47(42~52)	30	38	93			5.5		2100	5.4	1.9	
MVR10D560K	56(50~62)	35	45	110			7.0		1800	5.5	2.1	
MVR10D680K	68(61~75)	40	56	135			8.2		1500	5.6	2.4	
MVR10D820K	82(74~90)	50	65	135	25	2,500	12.0	0.4	1200	4.7	1.8	
MVR10D101K	100(90~110)	60	85	165			15.0		1000	4.9	2.0	
MVR10D121K	120(108~132)	75	100	200			18.0		830	5.1	2.2	
MVR10D151K	150(135~165)	95	125	250			22.0		670	5.4	1.8	
MVR10D181K	180(162~198)	115	150	300			27.0		560	4.8	1.9	
MVR10D201K	200(180~220)	130	170	340			30.0		500	5.0	2.0	
MVR10D221K	220(198~242)	140	180	360			32.0		450	5.1	2.1	
MVR10D241K	240(216~264)	150	200	395			35.0		420	5.2	2.2	
MVR10D271K	270(243~297)	175	225	455			40.0		370	5.4	2.4	
MVR10D301K	300(270~330)	190	250	500			40.0		330	5.5	2.5	
MVR10D331K	330(297~363)	210	275	550			43.0		300	5.8	2.5	
MVR10D361K	360(324~396)	230	300	595			47.0		280	6.0	2.7	
MVR10D391K	390(351~429)	250	320	650			60.0		260	6.2	2.8	
MVR10D431K	430(387~473)	275	350	710			65.0		230	6.5	3.0	
MVR10D471K	470(423~517)	300	385	775			67.0		210	6.7	3.2	
MVR10D511K	510(459~561)	320	415	845			69.0		200	6.8	3.4	
MVR10D561K	560(504~616)	350	460	925			70.0		180	7.0	3.6	
MVR10D621K	620(558~682)	385	505	1025			72.0		160	7.3	3.9	
MVR10D681K	680(612~748)	420	560	1120			75.0		150	7.6	4.2	
MVR10D751K	750(675~825)	460	615	1240			77.0		130	8.0	4.3	
MVR10D781K	780(702~858)	485	640	1290	80.0	130	8.1	4.4				
MVR10D821K	820(738~902)	510	670	1355	85.0	120	8.3	4.6				
MVR10D911K	910(819~1001)	550	745	1500	93.0	110	8.8	5.0				
MVR10D102K	1000(900~1100)	625	825	1650	102.0	100	9.3	5.0				
MVR10D112K	1100(990~1210)	680	895	1815	115.0	90	9.9	5.4				

Notes:

- The tolerance of varistor voltage between 18V and 27V is more than 10%.
- Leakage Current (@83% of V_{1mA}) : IR≤50µA (180K~680K) IR≤25µA (820K~112K)

Metal Oxide Varistor Leaded Disk Type, 5~25mm

MVR Series

MERITEK

SURGE CURRENT DERATING CURVES – MVR10D SERIES

[Back to Top](#)

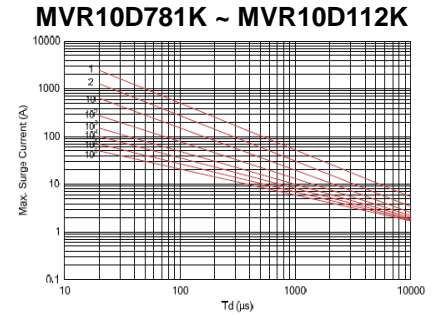
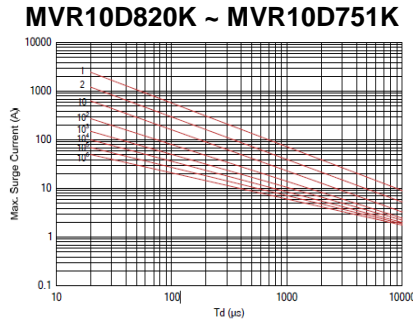
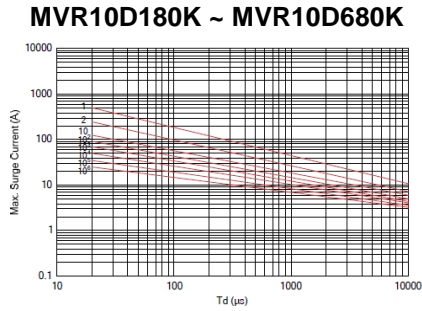

LEAKAGE CURRENT & CLAMPING VOLTAGE CURVES – MVR10D SERIES

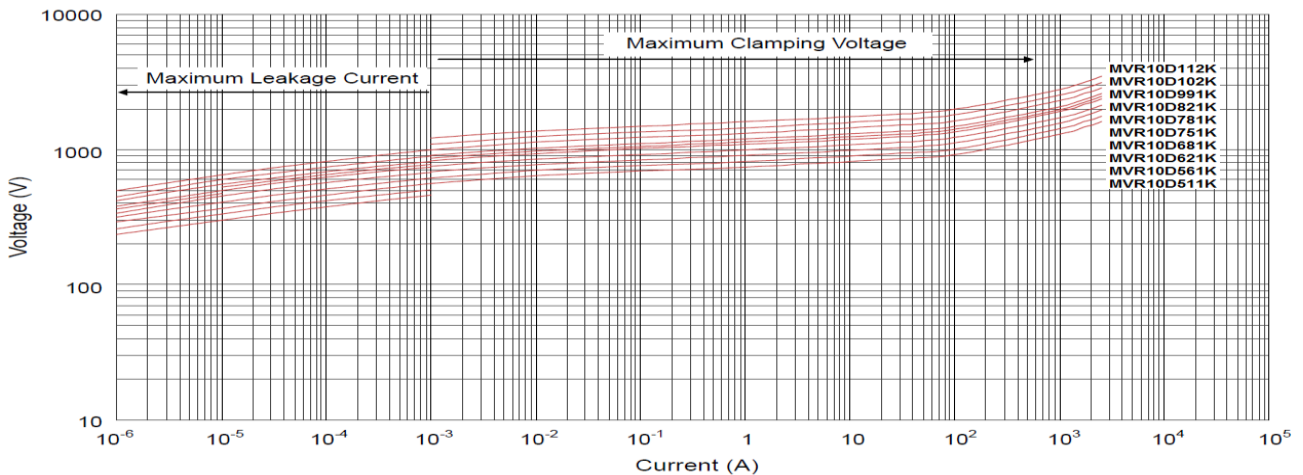
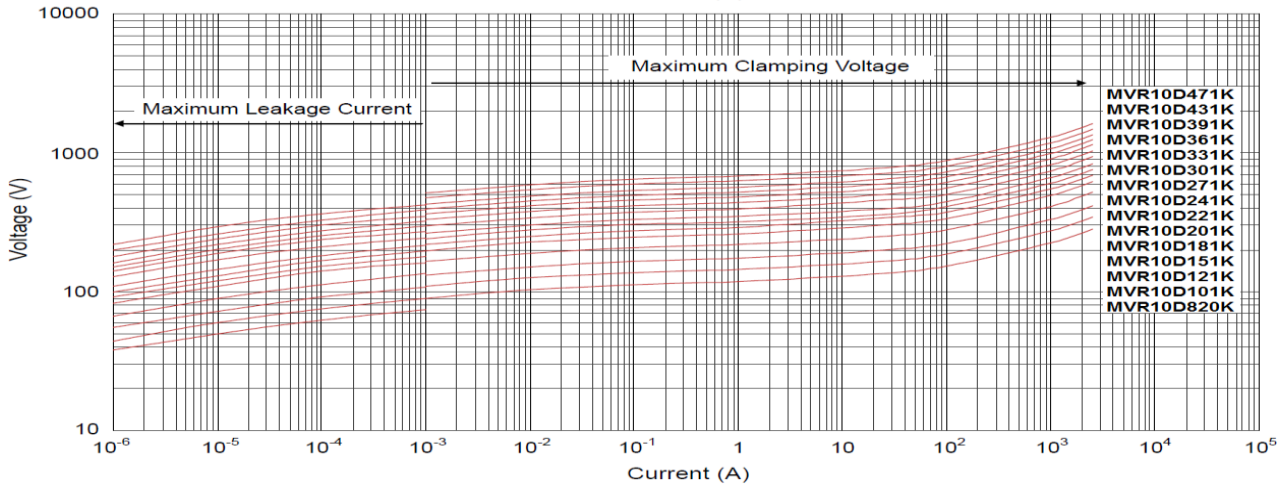
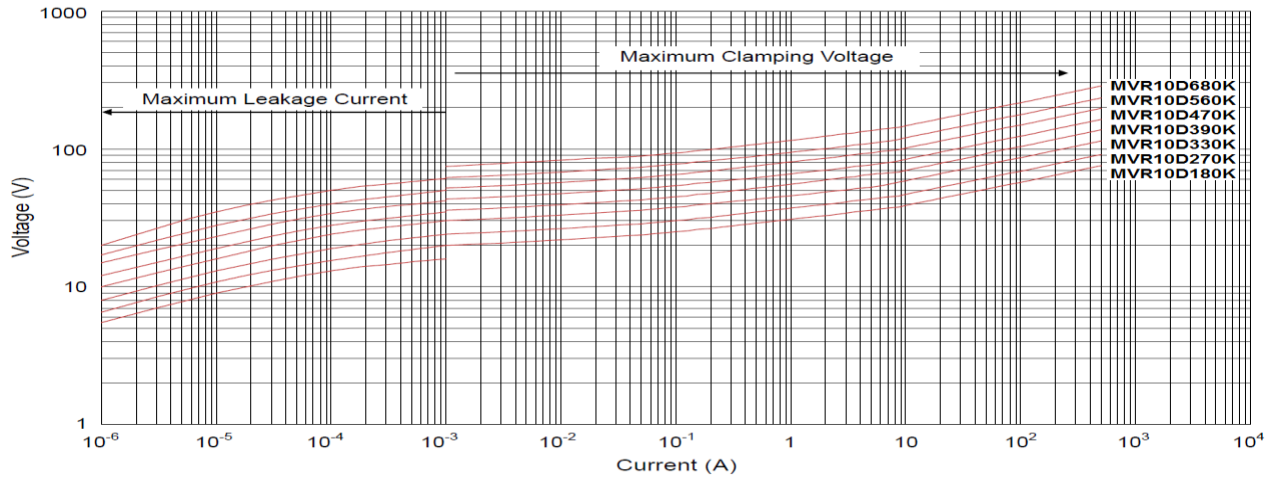

Metal Oxide Varistor Leaded Disk Type, 5~25mm

MVR Series

MERITEK

ELECTRICAL CHARACTERISTICS - MVR14D SERIES

[Back to Top](#)

MVR14D Series	Varistor DC Voltage @1mA		Max. Allowable Voltage		Max. Clamping Voltage		Withstanding Surge Current (A)	Max. Energy (10/1Kμs) (J)	Rated Power (W)	Typical Cap. @1kHz (pF)	Dimension	
	V _{DC}	V _{AC}	V _{DC}	V _c	I _P	T _{max}					e ±0.8	
	(V)	(V _{rms})	(V)	(V)	(A)							
MVR14D180K	18(15~21.6)	11	14	36	10	1,000	0.1	4.0	11100	3.9	1.5	
MVR14D220K	22(19.5~26)	14	18	43				5.0	9100	4.0	1.6	
MVR14D270K	27(24~31)	17	22	53				6.0	7400	4.1	1.8	
MVR14D330K	33(29.5~36.5)	20	26	65				7.5	6100	4.3	1.7	
MVR14D390K	39(35~43)	25	31	77				8.6	5100	4.1	1.8	
MVR14D470K	47(42~52)	30	38	93				10.0	4300	4.3	1.9	
MVR14D560K	56(50~62)	35	45	110				11.0	3600	4.6	2.1	
MVR14D680K	68(61~75)	40	56	135				14.0	2900	4.8	2.4	
MVR14D820K	82(74~90)	50	65	135				22.0	2400	4.1	1.8	
MVR14D101K	100(90~110)	60	85	165				28.0	2000	4.2	2.0	
MVR14D121K	120(108~132)	75	100	200				32.0	1700	4.4	2.2	
MVR14D151K	150(135~165)	95	125	250				40.0	1300	4.1	1.8	
MVR14D181K	180(162~198)	115	150	300				50.0	1100	4.2	1.9	
MVR14D201K	200(180~220)	130	170	340				57.0	1000	4.3	2.0	
MVR14D221K	220(198~242)	140	180	360	60.0	900	4.4	2.1				
MVR14D241K	240(216~264)	150	200	395	63.0	830	4.5	2.2				
MVR14D271K	270(243~297)	175	225	455	70.0	740	4.6	2.4				
MVR14D301K	300(270~330)	190	250	500	77.0	670	4.6	2.5				
MVR14D331K	330(297~363)	210	275	550	85.0	610	5.0	2.5				
MVR14D361K	360(324~396)	230	300	595	93.0	560	5.2	2.7				
MVR14D391K	390(351~429)	250	320	650	100	510	5.4	2.8				
MVR14D431K	430(387~473)	275	350	710	115	460	5.6	3.0				
MVR14D471k	470(423~517)	300	385	775	125	430	5.8	3.2				
MVR14D511K	510(459~561)	320	415	845	125	390	6.1	3.4				
MVR14D561K	560(504~616)	350	460	925	125	360	6.4	3.6				
MVR14D621K	620(558~682)	385	505	1025	125	320	6.8	3.9				
MVR14D681K	680(621~748)	420	560	1120	130	290	7.1	4.2				
MVR14D751K	750(675~825)	460	615	1240	143	270	7.2	4.3				
MVR14D781K	780(702~858)	485	640	1290	148	260	7.3	4.4				
MVR14D821K	820(738~902)	510	670	1355	157	240	7.5	4.6				
MVR14D911K	910(819~1001)	550	745	1500	175	220	7.5	5.0				
MVR14D102K	1000(900~1100)	625	825	1650	190	200	8.0	5.0				
MVR14D112K	1100(990~1210)	680	895	1815	213	180	8.5	5.4				
MVR14D122K	1200(1080~1320)	750	990	1980	232	160	9.0	5.8				
MVR14D142K	1400(1260~1540)	880	1140	2310	238	150	10.5	6.6				
MVR14D162K	1600(1440~1760)	1000	1280	2640	243	140	11.0	7.4				
MVR14D182K	1800(1620~1980)	1100	1465	2970	250	130	12.0	8.2				

Notes:

- The tolerance of varistor voltage between 18V and 27V is more than 10%.
- Varistor voltage ≥ 1200V, structure diagram is F type.
- Leakage Current (@83% of V_{1mA}) : I_R ≤ 50μA (180K~680K) ; I_R ≤ 25μA (820K~182K)

Metal Oxide Varistor Leaded Disk Type, 5~25mm

MVR Series

MERITEK

SURGE CURRENT DERATING CURVES - MVR14D SERIES

[Back to Top](#)

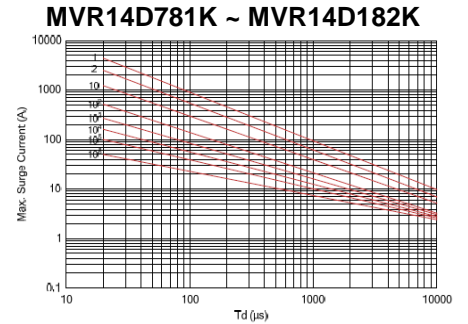
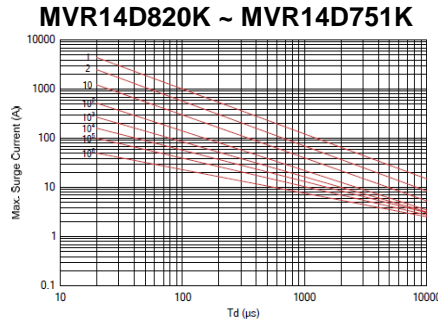
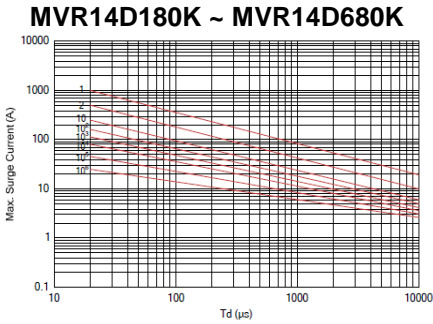

LEAKAGE CURRENT & CLAMPING VOLTAGE CURVES – MVR14D SERIES

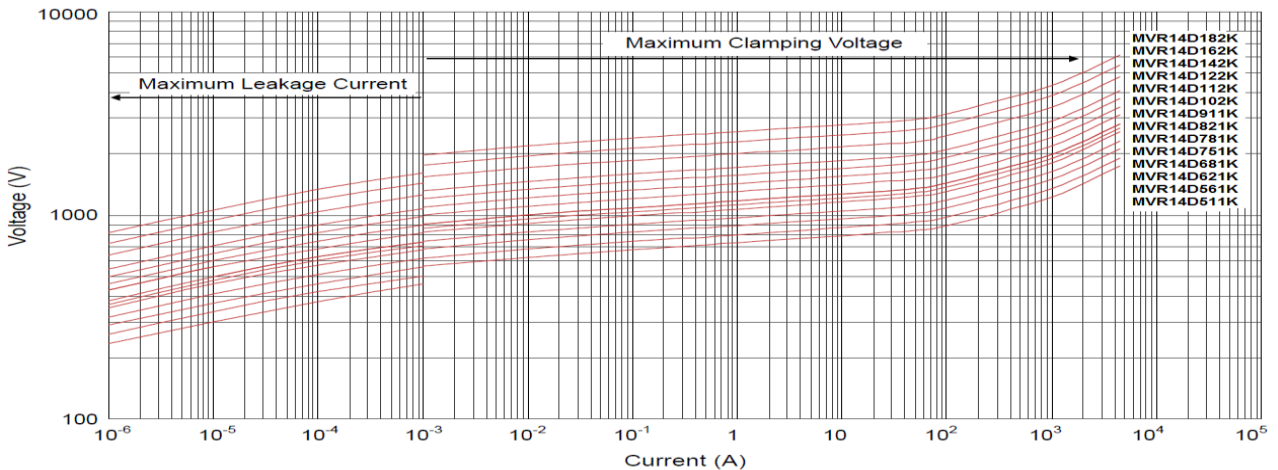
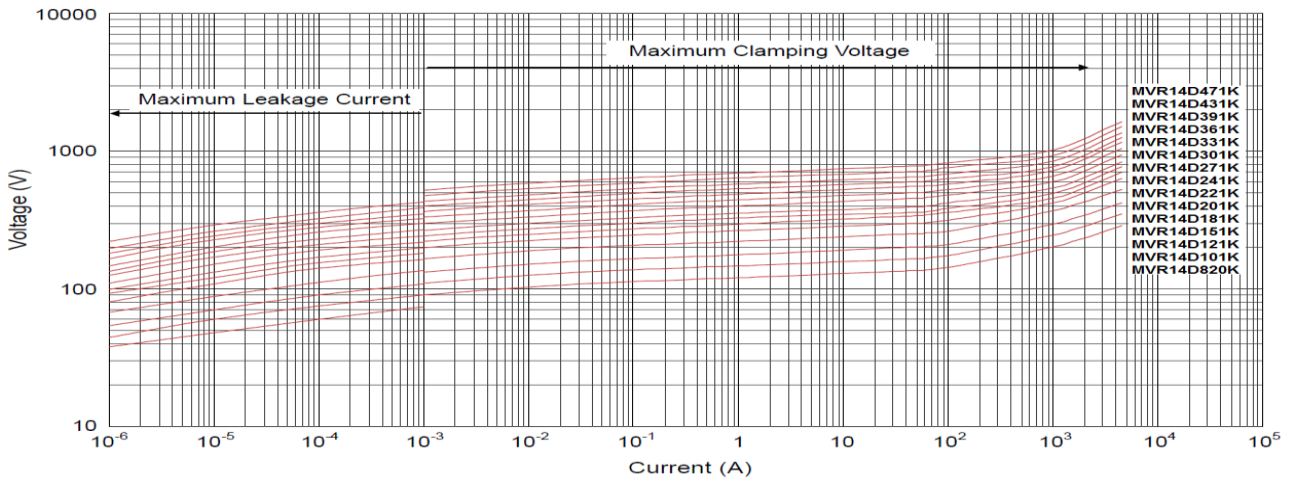
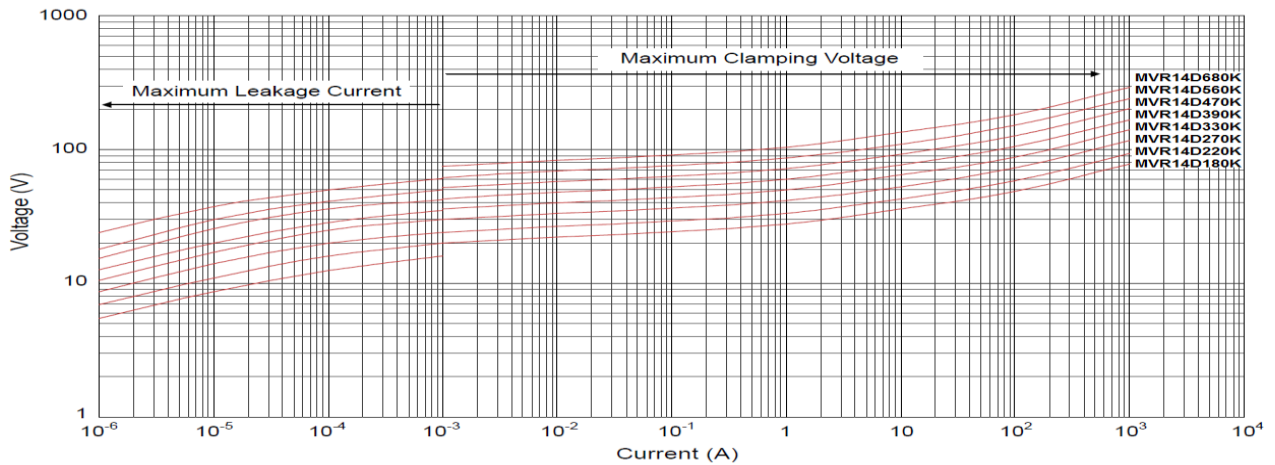

Metal Oxide Varistor Leaded Disk Type, 5~25mm

MVR Series

MERITEK

ELECTRICAL CHARACTERISTICS - MVR20D SERIES

[Back to Top](#)

MVR20D Series	Varistor DC Voltage @1mA		Max. Allowable Voltage		Max. Clamping Voltage		Withstanding Surge Current (A)	Max. Energy (10/1Kμs) (J)	Rated Power (W)	Typical Cap. @1kHz (pF)	Dimension	
	V _{DC}	V _{AC}	V _{DC}	V _c	I _P	T _{max}					e ±0.8	
	(V)	(V _{rms})	(V)	(V)	(A)							
MVR20D180K	18(15~21.6)	11	14	36	20	2,000	0.2	11	28500	4.3	1.7	
MVR20D220K	22(19.5~26)	14	18	43				14		18500	4.4	1.8
MVR20D270K	27(24~31)	17	22	53				16		13000	4.6	2.0
MVR20D330K	33(29.5~36.5)	20	26	65				23		11500	4.8	1.9
MVR20D390K	39(35~43)	25	31	77				26		8500	4.5	2.0
MVR20D470K	47(42~52)	30	38	93				30		7400	4.7	2.1
MVR20D560K	56(50~62)	35	45	110				41		6500	5.0	2.3
MVR20D680K	68(61~75)	40	56	135				46		5800	5.3	2.6
MVR20D820K	82(74~90)	50	65	135	100	6,500	1.0	38	4900	4.5	2.0	
MVR20D101K	100(90~110)	60	85	165				45	4000	4.6	2.2	
MVR20D121K	120(108~132)	75	100	200				55	3300	4.8	2.4	
MVR20D151K	150(135~165)	95	125	250				70	2700	4.5	2.0	
MVR20D181K	180(162~198)	115	150	300				85	2200	4.6	2.1	
MVR20D201K	200(180~220)	130	170	340				95	2000	4.7	2.2	
MVR20D221K	220(198~242)	140	180	360				100	1800	4.8	2.3	
MVR20D241K	240(216~264)	150	200	395				108	1650	4.9	2.4	
MVR20D271K	270(243~297)	175	225	455				127	1500	5.0	2.6	
MVR20D301K	300(270~330)	190	250	500				136	1300	5.0	2.7	
MVR20D331K	330(297~363)	210	275	550				150	1200	5.2	2.7	
MVR20D361K	360(324~396)	230	300	595				163	1100	5.4	2.9	
MVR20D391K	390(351~429)	250	320	650				180	1000	5.5	3.0	
MVR20D431K	430(387~473)	275	350	710				190	930	5.7	3.2	
MVR20D471k	470(423~517)	300	385	775				220	850	6.0	3.4	
MVR20D511K	510(459~561)	320	415	845				220	780	6.2	3.6	
MVR20D561K	560(504~616)	350	460	925				220	710	6.5	3.8	
MVR20D621K	620(558~682)	385	505	1025				220	650	6.8	4.1	
MVR20D681K	680(612~748)	420	560	1120				230	600	7.1	4.4	
MVR20D751K	750(675~825)	460	615	1240				255	530	7.5	4.5	
MVR20D781K	780(702~858)	485	640	1290				265	510	7.7	4.6	
MVR20D821K	820(738~902)	510	670	1355				282	500	7.9	4.8	
MVR20D911K	910(819~1001)	550	745	1500				310	440	8.1	5.2	
MVR20D102K	1000(900~1100)	625	825	1650				342	400	8.6	5.2	
MVR20D112K	1100(990~1210)	680	895	1815	383	360	9.1	5.6				
MVR20D122K	1200(1080~1320)	750	990	1980	408	350	9.7	6.0				
MVR20D142K	1400(1260~1540)	880	1140	2310	532	340	11.2	6.8				
MVR20D162K	1600(1440~1760)	1000	1280	2640	606	330	11.8	7.6				
MVR20D182K	1800(1620~1980)	1100	1465	2970	625	320	12.8	8.4				

Notes:

- The tolerance of varistor voltage between 18V and 27V is more than 10%.
- Varistor voltage ≥ 1200V, structure diagram is F type.
- Leakage Current (@83% of V_{1mA}) : IR ≤ 50μA (180K~680K) ; IR ≤ 25μA (820K~182K)

Metal Oxide Varistor Leaded Disk Type, 5~25mm

MVR Series

MERITEK

SURGE CURRENT DERATING CURVES - MVR20D SERIES

[Back to Top](#)

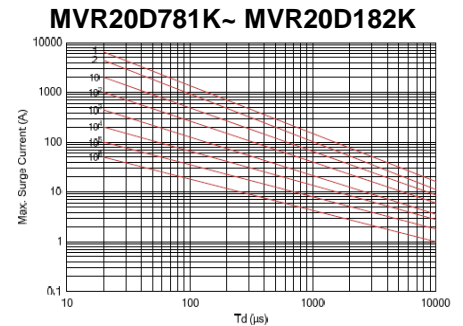
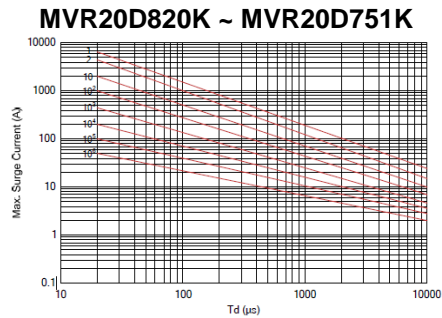
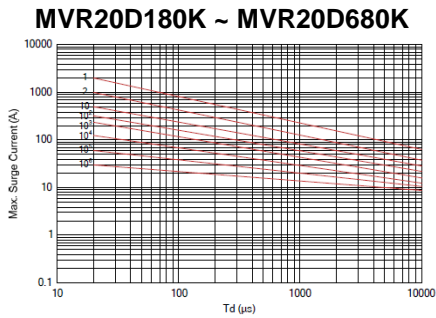

LEAKAGE CURRENT & CLAMPING VOLTAGE CURVES - MVR20D SERIES

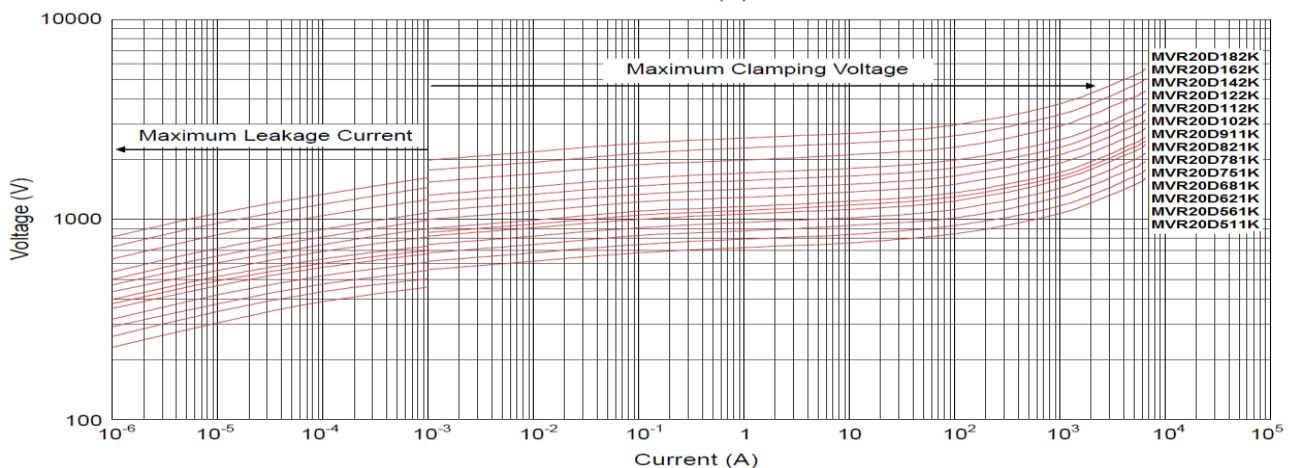
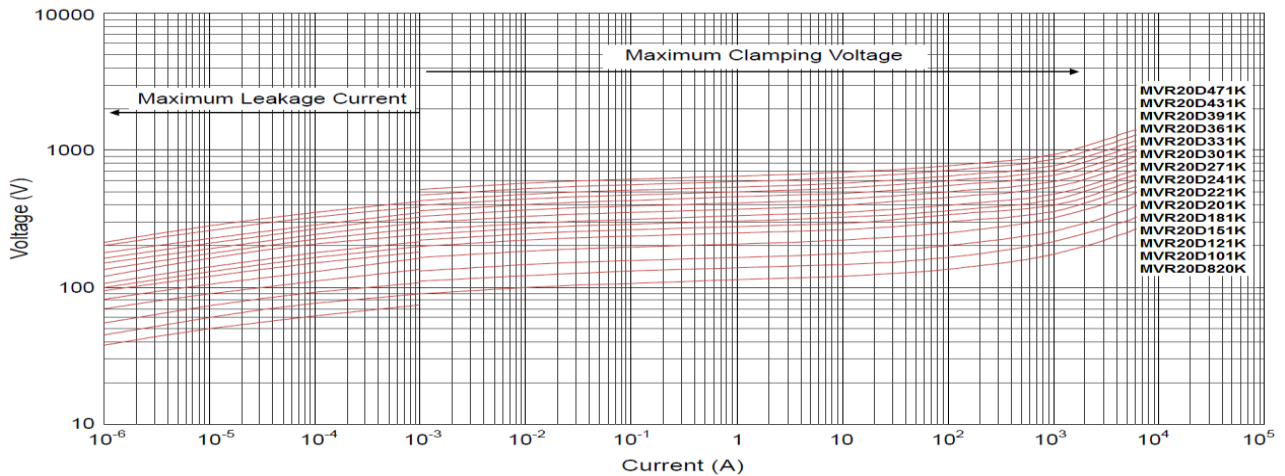
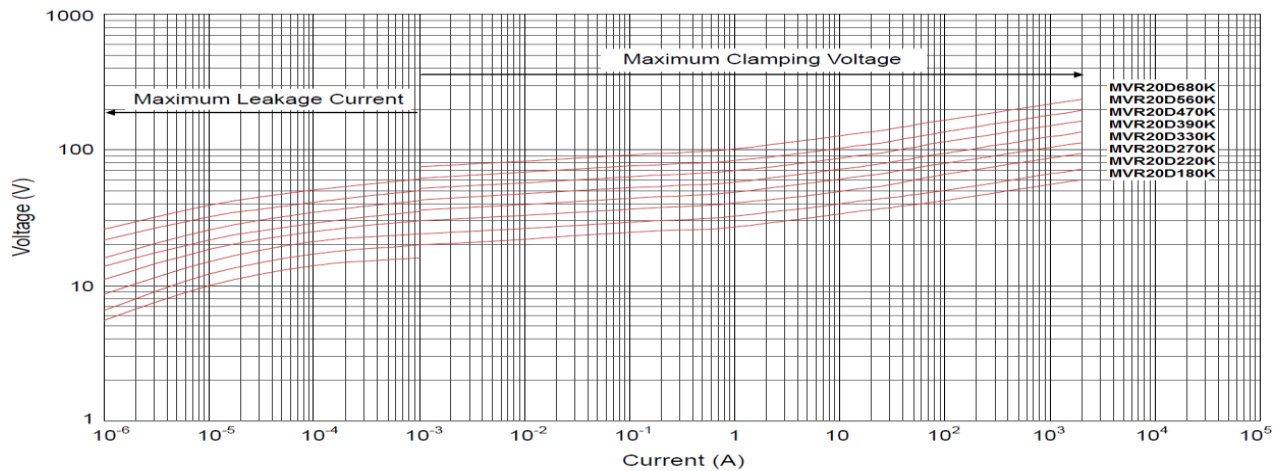

Metal Oxide Varistor Leaded Disk Type, 5~25mm

MVR Series

MERITEK

ELECTRICAL CHARACTERISTICS - MVR25D SERIES

[Back to Top](#)

MVR25D Series	Varistor DC Voltage @1mA		Max. Allowable Voltage		Max. Clamping Voltage		Withstanding Surge Current (A)	Max. Energy (10/1Kμs) (J)	Rated Power (W)	Typical Cap. @1kHz (pF)	Dimension	
	V _{DC}	V _{AC}	V _{DC}	V _c	I _p	T max					e	
	(V)	(V _{rms})	(V)	(V)	(A)						±0.8	
MVR25D180K	18(15~21.6)	11	14	36	30	4,500	0.25	20	0.25	45000	4.8	1.7
MVR25D220K	22(19.5~26)	14	18	43				25		29000	4.9	1.8
MVR25D270K	27(24~31)	17	22	53				30		26500	5.0	2.0
MVR25D330K	33(29.5~36.5)	20	26	65				35		18000	5.2	1.9
MVR25D390K	39(35~43)	25	31	77				40		13500	5.5	2.0
MVR25D470K	47(42~52)	30	38	93				50		11500	5.1	2.1
MVR25D560K	56(50~62)	35	45	110				60		10500	5.4	2.3
MVR25D680K	68(61~75)	40	56	135				70		9050	5.7	2.6
MVR25D820K	82(74~90)	50	65	135	150	15,000	1.2	80	1.2	7700	4.5	2.0
MVR25D101K	100(90~110)	60	85	165				100		6300	4.6	2.2
MVR25D121K	120(108~132)	75	100	200				120		5200	4.8	2.4
MVR25D151K	150(135~165)	95	125	250				160		4300	4.9	2.0
MVR25D181K	180(162~198)	115	150	300				175		3500	5.2	2.1
MVR25D201K	200(180~220)	130	170	340				190		3200	5.2	2.2
MVR25D221K	220(198~242)	140	180	360				200		2900	5.3	2.3
MVR25D241K	240(216~264)	150	200	395				220		2650	5.8	2.4
MVR25D271K	270(243~297)	175	225	455				255		2400	5.3	2.6
MVR25D301K	300(270~330)	190	250	500				275		2100	5.5	2.7
MVR25D331K	330(297~363)	210	275	550				300		1900	5.7	2.7
MVR25D361K	360(324~396)	230	300	595				330		1750	5.9	2.9
MVR25D391K	390(351~429)	250	320	650				360		1600	6.1	3.0
MVR25D431K	430(387~473)	275	350	710				380		1500	6.4	3.2
MVR25D471k	470(423~517)	300	385	775				400		1400	6.7	3.4
MVR25D511K	510(459~561)	320	415	845				420		1250	7.0	3.6
MVR25D561K	560(504~616)	350	460	925				440		1150	7.3	3.8
MVR25D621K	620(558~682)	385	505	1025				450		1050	7.6	4.1
MVR25D681K	680(612~748)	420	560	1120				460		950	7.8	4.4
MVR25D751K	750(675~825)	460	615	1240				510		850	8.0	4.5
MVR25D781K	780(702~858)	485	640	1290				530		850	8.1	4.6
MVR25D821K	820(738~902)	510	670	1355				570		800	8.4	4.8
MVR25D911K	910(819~1001)	550	745	1500				620		700	8.9	5.2
MVR25D102K	1000(900~1100)	625	825	1650				685		650	9.5	5.2
MVR25D112K	1100(990~1210)	680	895	1815	720	600	10.1	5.6				
MVR25D122K	1200(1080~1320)	750	990	1980	792	550	10.7	6.0				
MVR25D142K	1400(1260~1540)	880	1140	2310	850	500	12.6	6.8				
MVR25D162K	1600(1440~1760)	1000	1280	2640	970	450	13.2	7.6				
MVR25D182K	1800(1620~1980)	1100	1465	2970	1092	400	14.5	8.4				

Notes:

- The tolerance of varistor voltage between 18V and 27V is more than 10%.
- Leakage Current (@83% of V_{1mA}) : IR≤50μA (180K~680K) ; IR≤40μA (820K~182K)

Metal Oxide Varistor Leaded Disk Type, 5~25mm

MVR Series

MERITEK

SURGE CURRENT DERATING CURVES – MVR25D SERIES

[Back to Top](#)

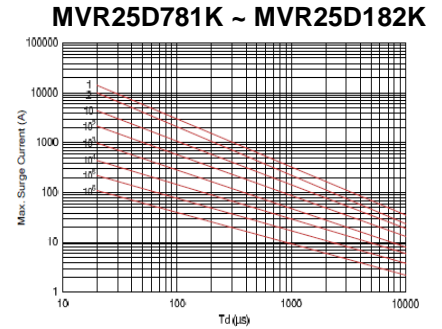
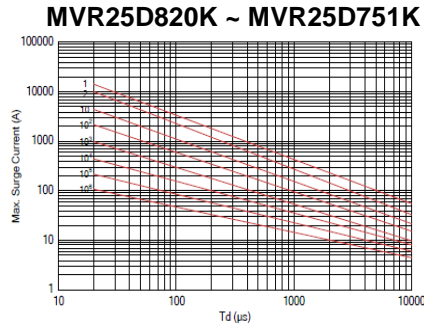
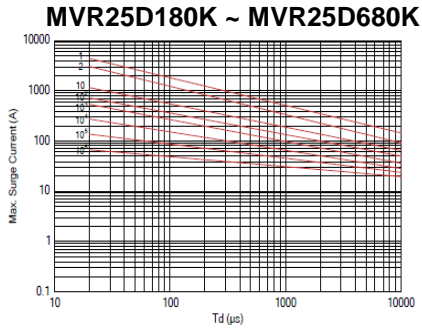

LEAKAGE CURRENT & CLAMPING VOLTAGE CURVES - MVR25D SERIES

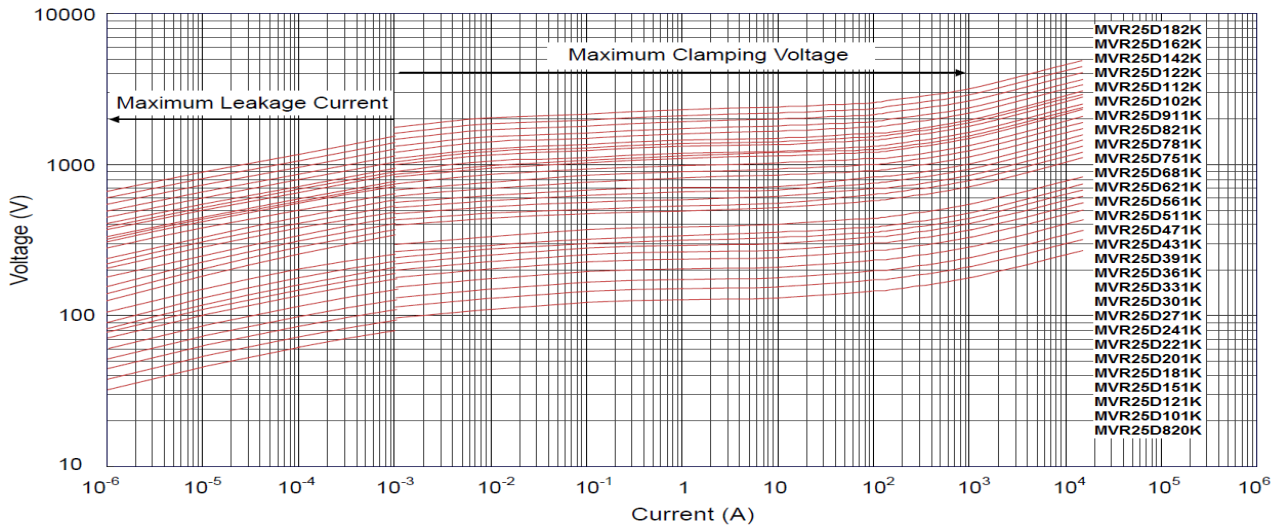
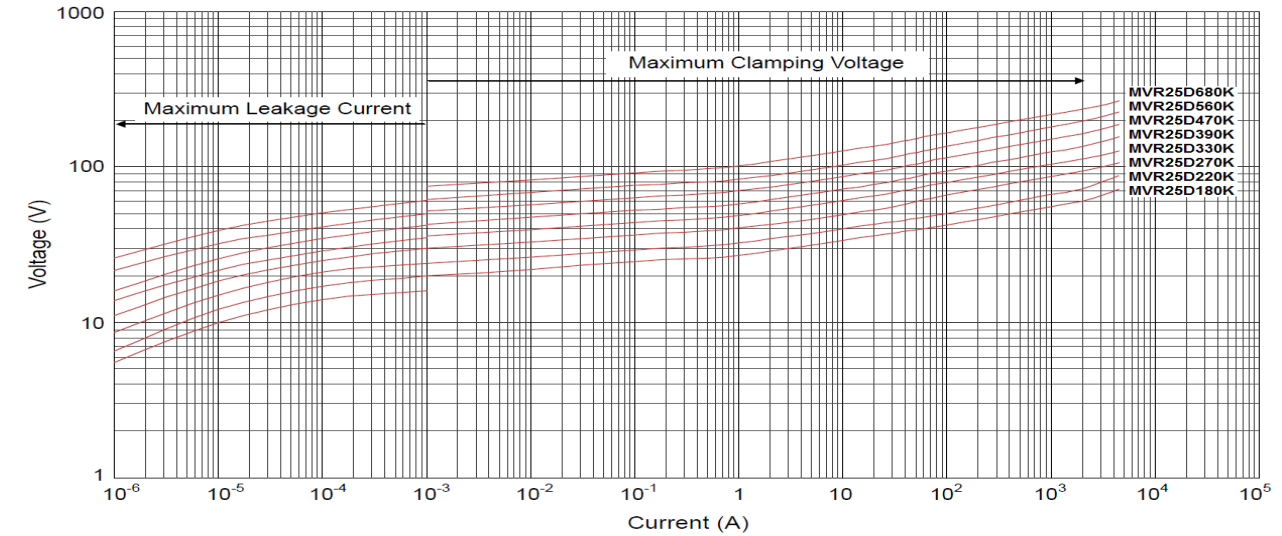

Metal Oxide Varistor Leaded Disk Type, 5~25mm

MVR Series

MERITEK

RELIABILITY TEST CONDITIONS AND REQUIREMENTS

[Back To Top](#)

Item	Test Conditions / Method	Specifications															
Tensile Strength of Terminals	<p>Gradually apply the specified force and keep the unit fixed for 10±1s.</p> <table border="1"> <thead> <tr> <th>Terminal diameter (mm)</th> <th>Force (Kg)</th> </tr> </thead> <tbody> <tr> <td>0.5<d≤0.8</td> <td>1.0</td> </tr> <tr> <td>0.8<d≤1.25</td> <td>2.0</td> </tr> <tr> <td>1.25<d</td> <td>4.0</td> </tr> </tbody> </table>	Terminal diameter (mm)	Force (Kg)	0.5<d≤0.8	1.0	0.8<d≤1.25	2.0	1.25<d	4.0	$ \Delta V_{1mA}/V_{1mA} \leq 5\%$ No visible damage							
Terminal diameter (mm)	Force (Kg)																
0.5<d≤0.8	1.0																
0.8<d≤1.25	2.0																
1.25<d	4.0																
Bending Strength of Terminals	<p>Hold specimen and apply the force specified below to each lead. Bend the specimen to 90°, and then return to the original position. Repeat the procedure in the opposite direction.</p> <table border="1"> <thead> <tr> <th>Terminal diameter (mm)</th> <th>Force (Kg)</th> </tr> </thead> <tbody> <tr> <td>0.5<d≤0.8</td> <td>0.5</td> </tr> <tr> <td>0.8<d≤1.25</td> <td>1.0</td> </tr> <tr> <td>1.25<d</td> <td>2.0</td> </tr> </tbody> </table>	Terminal diameter (mm)	Force (Kg)	0.5<d≤0.8	0.5	0.8<d≤1.25	1.0	1.25<d	2.0	$ \Delta V_{1mA}/V_{1mA} \leq 5\%$ No visible damage							
Terminal diameter (mm)	Force (Kg)																
0.5<d≤0.8	0.5																
0.8<d≤1.25	1.0																
1.25<d	2.0																
Vibration	Frequency range: 10 ~ 55 Hz, Amplitude: 0.75mm or 98 m/s ² Direction: 3 mutually perpendicular directions, 2 hrs. each.	$ \Delta V_{1mA}/V_{1mA} \leq 5\%$ No visible damage															
Solderability	245±5°C , 2±0.5 sec	At least 95% of terminal electrode is covered by solder															
Resistance to Soldering Heat	260±5°C , 10±1 sec	$ \Delta V_{1mA}/V_{1mA} \leq 5\%$ No visible damage															
High Temperature Storage	125±2°C x 1000 hrs.	$ \Delta V_{1mA}/V_{1mA} \leq 5\%$ No visible damage															
Low Temperature Storage	-40±2°C x 1000 hrs.	$ \Delta V_{1mA}/V_{1mA} \leq 5\%$ No visible damage															
Damp Heat, Steady State	1000 hrs. at 40±2°C, 90 ~ 95 % RH, at max. allowable voltage	$ \Delta V_{1mA}/V_{1mA} \leq 10\%$ No visible damage															
Rapid Change of Temperature	The conditions shown below shall be repeated 5 cycles. <table border="1"> <thead> <tr> <th>Step</th> <th>Temperature (°C)</th> <th>Period (minutes)</th> </tr> </thead> <tbody> <tr> <td>1</td> <td>-40±3</td> <td>30±3</td> </tr> <tr> <td>2</td> <td>Room temperature</td> <td>5±3</td> </tr> <tr> <td>3</td> <td>125±3</td> <td>30±3</td> </tr> <tr> <td>4</td> <td>Room temperature</td> <td>5±3</td> </tr> </tbody> </table>	Step	Temperature (°C)	Period (minutes)	1	-40±3	30±3	2	Room temperature	5±3	3	125±3	30±3	4	Room temperature	5±3	$ \Delta V_{1mA}/V_{1mA} \leq 5\%$ No visible damage
Step	Temperature (°C)	Period (minutes)															
1	-40±3	30±3															
2	Room temperature	5±3															
3	125±3	30±3															
4	Room temperature	5±3															
High Temperature Load Life	1000 hrs. at 105±2°C, Max allowable AC Voltage	$ \Delta V_{1mA}/V_{1mA} \leq 10\%$ No visible damage															
Voltage Proof	Metal balls method, 2500 Vac 1 min	No visible damage															
Varistor Voltage Temp. Coefficient	$\frac{V_{1mA} \text{ at } 85^{\circ}\text{C} - V_{1mA} \text{ at } 25^{\circ}\text{C}}{V_{1mA} \text{ at } 25^{\circ}\text{C}} \times \frac{1}{80} \times 100(\%/^{\circ}\text{C})$ $\frac{V_{1mA} \text{ at } -40^{\circ}\text{C} - V_{1mA} \text{ at } 25^{\circ}\text{C}}{V_{1mA} \text{ at } 25^{\circ}\text{C}} \times \frac{1}{65} \times 100(\%/^{\circ}\text{C})$	-0.05≤TC≤0.05(%/°C)															

Metal Oxide Varistor Leaded Disk Type, 5~25mm

MVR Series

MERITEK

RELIABILITY TEST CONDITIONS AND REQUIREMENTS (CONTINUED) [Back To Top](#)

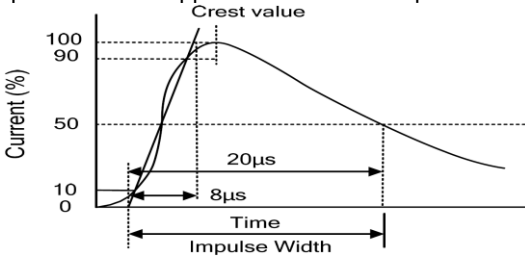
Item	Test Conditions / Method	Specifications	
Surge Life (8/20μs)	The Varistor voltage (V_{1mA}) shall be measured after the impulse listed below is applied 10,000 times continuously with the interval of ten seconds at room temperature.		
	05D Series	108K to 680K 820K to 751K	10A (8/20μs) 20A (8/20μs)
		07D Series	180K to 680K 820K to 821K
	10D Series		180K to 680K 820K to 112K
		14D Series	180K to 680K 820K to 182K
	20D Series		180K to 680K 820K to 182K
		Varistor Voltage	The voltage between two terminals with the specified measuring current 1mA. DC applied is called V_{1mA}
Maximum Allowable Voltage	The recommended maximum sine wave voltage (RMS) or the Maximum DC voltage can be applied continuously.		
Maximum Clamping Voltage	The maximum voltage between two terminals with the specification standard impulse current. Applied waveform: 8/20μs 		
Rated Voltage	The maximum average power that can be applied within the specified ambient temperature.		
Energy	The maximum energy within the varistor voltage change of $\pm 10\%$ when one impulse of 10/1000μs or 2ms is applied.		
Withstanding Surge Current	The maximum current within the varistor voltage change of $\pm 10\%$ with the standard impulse current (8/20μs) applied one time.		

SOLDERING RECOMMENDATION

Wave Soldering Process	Condition
Peak Temperature	265°C
Dipping Time	10 seconds (max)
Soldering	1 Time

Soldering Iron Process	Condition
Temperature of Soldering Iron-tip	360°C (max.)
Soldering Time	3 sec. (max.)
Distance From Varistor	2 mm (min.)

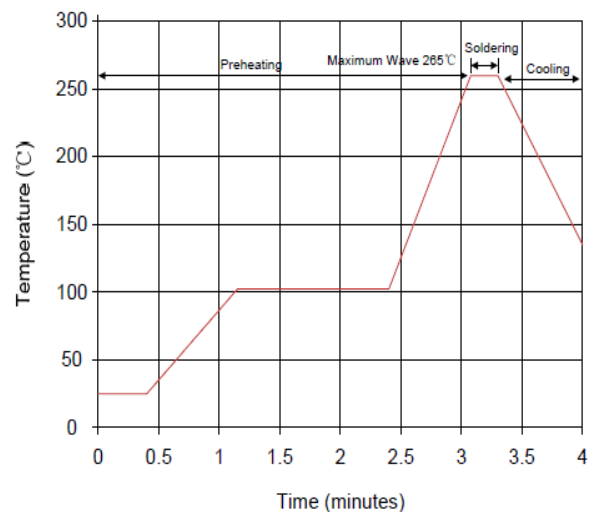

Meritek Varistor Series: <http://www.meritekusa.com/EN/productlist/node/15>

Meritek Product Series: <http://www.meritekusa.com/EN/products>

*Specifications subject to change without notice.