

AMLV

Automotive grade multilayer varistor

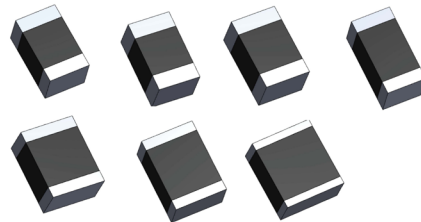

Product features

- AEC-Q200 qualified
- Seven compact footprint options: 0402 (1005 metric) , 0603 (1608 metric), 0805 (2012 metric), 1206 (3216 metric), 1210 (3225 metric), 1812 (4532 metric), 2220 (5750 metric)
- Working voltage: 5.5 Vdc to 56 Vdc
4.0 Vac to 40 Vac
- Bi-directional
- Peak current (8/20 μ s) up to 1200 A
- Multilayer construction suited for high reliability automotive applications
- V-jump and load-dump protection
- Meets moisture sensitivity level (MSL): 1

Applications

- Various automotive electrical control unit (ECU) applications
- Automotive bus systems (LIN, CAN, CAN-FD, FlexRay)
- Advanced driver assistance system (ADAS)
- In vehicle infotainment system (IVI)
- Seat motor circuit
- LED driver/ LED lamp
- Keyless entry
- Bluetooth
- Wiper motor
- Door control module

Environmental compliance



Ordering part number

AMLV 04 V05 C033

Family name

Package size

Working voltage (Vdc)

Capacitance code (pf)

Product specifications

Part number	Working voltage		Varistor voltage @ 1 mAdc		Maximum clamping voltage 8/20 μ s (V)	Energy absorption 10/1000 μ s (J)	Peak current 8/20 μ s (A)	Typical capacitance @ 1 MHz (pF)	V _{jump} (5 min) (V)	W _{LD} (10x) (J)	Leakage current @ Vdc (μ A)
	(Vdc)	(Vac)	(V min)	(V max)							
AMLV04V05C033	5.5	4	8.8	13.2	31 @ 1 A	0.02	4	33 @ 1 MHz	-	-	\leq 20
AMLV04V05C090	5.5	4	8.8	13.2	30 @ 1 A	0.05	10	90 @ 1 MHz	-	-	\leq 20
AMLV04V18C012	18	14	22	28	55 @ 1 A	0.03	2	12 @ 1 MHz	-	-	\leq 20
AMLV04V18C040	18	14	22	28	50 @ 1 A	0.05	20	40 @ 1 MHz	-	-	\leq 20
AMLV06V09C490	9	7	11	16	29 @ 1 A	0.1	30	490 @ 1 MHz	-	-	\leq 20
AMLV06V18C012	18	14	23	30	55 @ 1 A	0.03	2	12 @ 1 MHz	-	-	\leq 20
AMLV06V26C110	26	20	31	38	60 @ 1 A	0.1	30	110 @ 1 MHz	-	-	\leq 20
AMLV06V32C010	32	25	51.9	70.1	120 @ 1 A	0.05	5	10 @ 1 MHz	-	-	\leq 20
AMLV08V16C650	16	12	21.6	26.4	40 @ 1 A	0.3	120	650 @ 1 kHz	24.5	1	\leq 20
AMLV08V18C650	18	14	23	28	44 @ 1 A	0.3	120	650 @ 1 kHz	24.5	1	\leq 20
AMLV08V26C500	26	20	29.7	36.3	56 @ 1 A	0.3	80	500 @ 1 kHz	27	1	\leq 20
AMLV08V31C250	31	25	35.1	42.9	67 @ 1 A	0.3	80	250 @ 1 kHz	29	0.5	\leq 20
AMLV12V18C1000	18	14	22.95	28.05	42 @ 1 A	0.6	150	1000 @ 1 kHz	24.5	1.5	\leq 20
AMLV12V26C800	26	20	29.7	36.3	54 @ 1 A	0.7	200	800 @ 1 kHz	27.5	1.2	\leq 20
AMLV12V34C550	34	26	42.3	51.7	77 @ 1 A	0.4	200	550 @ 1 kHz	50	1.5	\leq 20
AMLV12V48C270	48	37	55.8	68.2	100 @ 1 A	0.4	100	270 @ 1 kHz	59	1.2	\leq 20
AMLV12V56C250	56	40	61.2	74.8	110 @ 1 A	0.5	100	250 @ 1 kHz	65	1.5	\leq 20
AMLV13V18C3100	18	14	22.95	28.05	42 @ 2.5 A	1.6	500	3100 @ 1 kHz	27.5	3	\leq 20
AMLV13V26C1500	26	20	29.7	36.3	54 @ 2.5 A	1.9	400	1500 @ 1 kHz	27	3	\leq 20
AMLV13V31C1200	31	25	35.1	42.9	65 @ 2.5 A	1.7	300	1200 @ 1 kHz	29	3	\leq 20
AMLV13V34C1100	34	26	42.3	51.7	75 @ 2.5 A	2.3	300	1100 @ 1 kHz	50	3	\leq 20
AMLV13V45C600	45	35	50.4	61.6	90 @ 2.5 A	2.0	250	600 @ 1 kHz	60	1.5	\leq 20
AMLV18V16C4500	16	12	21.6	26.4	40 @ 5 A	2.4	800	4500 @ 1 kHz	24.5	6	\leq 20
AMLV18V26C3200	26	20	29.7	36.3	54 @ 5 A	3.0	800	3200 @ 1 kHz	30	6	\leq 20
AMLV18V30C1700	30	23	35	43.0	77 @ 5 A	3.8	600	1700 @ 1 kHz	45	6	\leq 20
AMLV22V16C20000	16	12	21.6	26.4	42 @ 10 A	10	1200	20000 @ 1 kHz	24.5	25	\leq 20
AMLV22V34C6500	34	26	42.3	51.7	77 @ 10 A	12	1200	6500 @ 1 kHz	50	12	\leq 20
AMLV22V38C3000	38	30	42.3	51.7	77 @ 10 A	12	1000	3000 @ 1 kHz	50	12	\leq 20

Construction

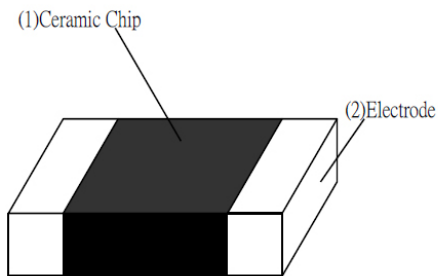

Component	Material
1. Ceramic chip	Metal oxides
2. Electrode	Ag-Ni-Sn

Dimensions – mm

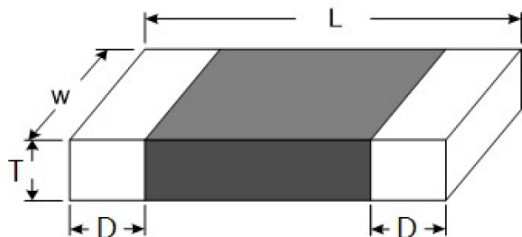

Pad layout

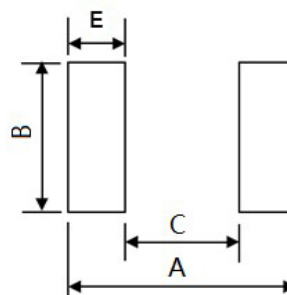

Part size	L	W	T (maximum)	D	A	B	C	E
AMLV04	1.00±0.15	0.50±0.10	0.6	0.20±0.10	1.7	0.6	0.5	0.6
AMLV06	1.60±0.15	0.80±0.15	0.95	0.35±0.15	2.8	1	0.8	1
AMLV08	2.00±0.20	1.25±0.20	1	0.40±0.20	3.4	1.4	1	1.2
AMLV12	3.20±0.30	1.60±0.20	1.5	0.50±0.20	4.5	1.8	2.1	1.2
AMLV13	3.20±0.30	2.50±0.25	1.5	0.50±0.20	4.5	2.8	2.1	1.2
AMLV18	4.50±0.40	3.20±0.30	2	0.60±0.30	6	3.6	3	1.5
AMLV22	5.70±0.40	5.00±0.30	2.5	0.60±0.30	7.2	5.5	4.2	1.5

General specifications

Operating temperature	- 55 °C to +125 °C (without derating)																																												
Storage temperature (component)	- 55 °C to +150 °C																																												
High temperature exposure	MIL-STD-202 Method 108, Temperature: +150 °C +3/-0 °C, Duration 1000 hours unpowered																																												
Temperature cycling	JESD22 Method JA-104, Temperature: -55 °C to +125 °C. Maximum transfer time 60 s, dwell time 30 min (air-air), Number of cycles: 1000 cycles																																												
	MIL-STD-202 Method 106, Duration of 1 cycle 24 hours, Number of cycles: 10 unpowered																																												
Moisture resistance	<table border="1"> <thead> <tr> <th rowspan="2">Step</th> <th colspan="2">Temp./ °C</th> <th>Humidity</th> <th>Period</th> </tr> <tr> <th>Start</th> <th>Finish</th> <th>%</th> <th>hr</th> </tr> </thead> <tbody> <tr> <td>1</td> <td>25</td> <td>65</td> <td>90-100</td> <td>2.5</td> </tr> <tr> <td>2</td> <td>65</td> <td>65</td> <td>90-100</td> <td>3.0</td> </tr> <tr> <td>3</td> <td>65</td> <td>25</td> <td>80-100</td> <td>2.5</td> </tr> <tr> <td>4</td> <td>25</td> <td>65</td> <td>90-100</td> <td>2.5</td> </tr> <tr> <td>5</td> <td>65</td> <td>65</td> <td>90-100</td> <td>3.0</td> </tr> <tr> <td>6</td> <td>65</td> <td>25</td> <td>80-100</td> <td>2.5</td> </tr> <tr> <td>7</td> <td>25</td> <td>25</td> <td>80-100</td> <td>8.0</td> </tr> </tbody> </table>	Step	Temp./ °C		Humidity	Period	Start	Finish	%	hr	1	25	65	90-100	2.5	2	65	65	90-100	3.0	3	65	25	80-100	2.5	4	25	65	90-100	2.5	5	65	65	90-100	3.0	6	65	25	80-100	2.5	7	25	25	80-100	8.0
Step	Temp./ °C		Humidity	Period																																									
	Start	Finish	%	hr																																									
1	25	65	90-100	2.5																																									
2	65	65	90-100	3.0																																									
3	65	25	80-100	2.5																																									
4	25	65	90-100	2.5																																									
5	65	65	90-100	3.0																																									
6	65	25	80-100	2.5																																									
7	25	25	80-100	8.0																																									
Biased humidity	MIL-STD-202 Method 103, Temperature: +85 °C, Humidity: 85%, Duration: 1000 hours, Bias at working voltage Vdc																																												
Operational life	MIL-STD-202 Method 108, Temperature: +125 °C, Duration: 1000 hours, Bias at working voltage Vdc																																												
Resistance to solvent	MIL-STD-202 Method 215, Solvent 1: 1 part (by volume) of isopropyl alcohol, 3 parts (by volume) of mineral spirits																																												
Mechanical shock	MIL-STD-202 Method 213, Test condition F Peak value: 1500 g's, Half sin waveform, normal duration 0.5 ms, In 3 directions perpendicularly intersecting each other (total 18 times)																																												
Vibration	MIL-STD-202 Method 204, Acceleration: 5 g's Sweep time: 20 minutes, Frequency range: 10 to 2000 Hz, 3 x 12 cycles																																												
Resistance to soldering heat	MIL-STD-202 Method 210, Condition B, no pre-heat of samples. Temperature: +260 ± 5 °C, time: 10 ± 1 s. Immersion and emersion rate: 25 mm/s ± 6 mm/s, 1 cycle																																												
Thermal shock	MIL-STD-202 Method 107, Temperature: -55 °C + 0/-3 °C to +125 °C + 3/-0 °C max., transfer time: 20 s, Dwell time: 15 minutes, air to air Number of cycles: 300 cycles																																												
ESD	AEC-Q200-002, Discharge capacitance: 150 pF Charging voltage: 30 kV min, Contact discharge, 1 pulse each polarity																																												
Solderability	IEC60068-2-58, J-STD-002, a) 4 hours @ +155 °C dry heat, dip @ +245 ± 5 °C, 3 ± 0.3 s b) Steam aging 8 hours ± 15 minutes @ +93 ± 3 °C, dip @ +260 ± 5 °C, 7 ± 0.5 s, 95% of termination wetted																																												
Board flex	AEC-Q200-005, Bend the board: 2 mm (min.), Duration of the applied forces: 60 + 5/-0 S No visible damage																																												
Electrical transient conduction	ISO7637-2, Test pulses 5a																																												

Maximum surge current derating curves

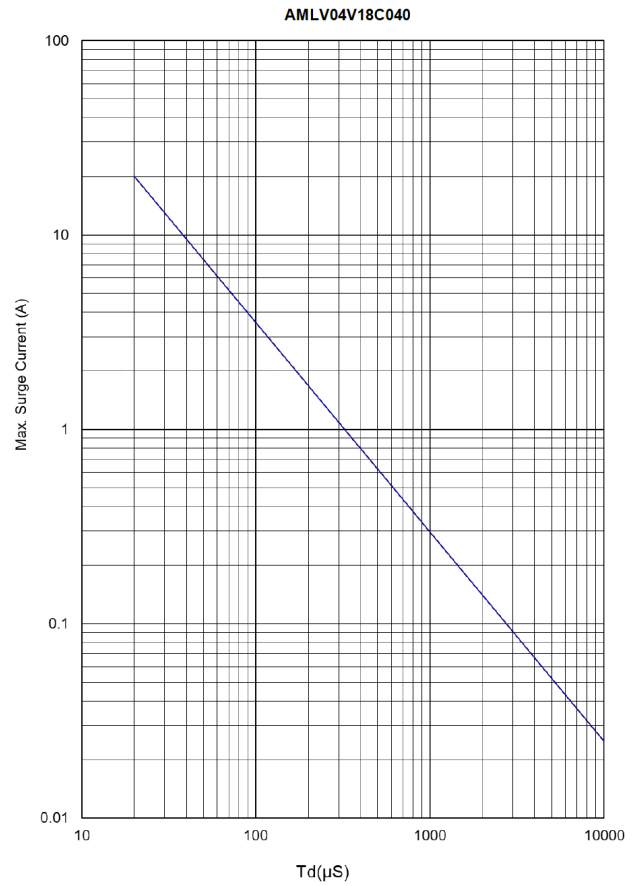
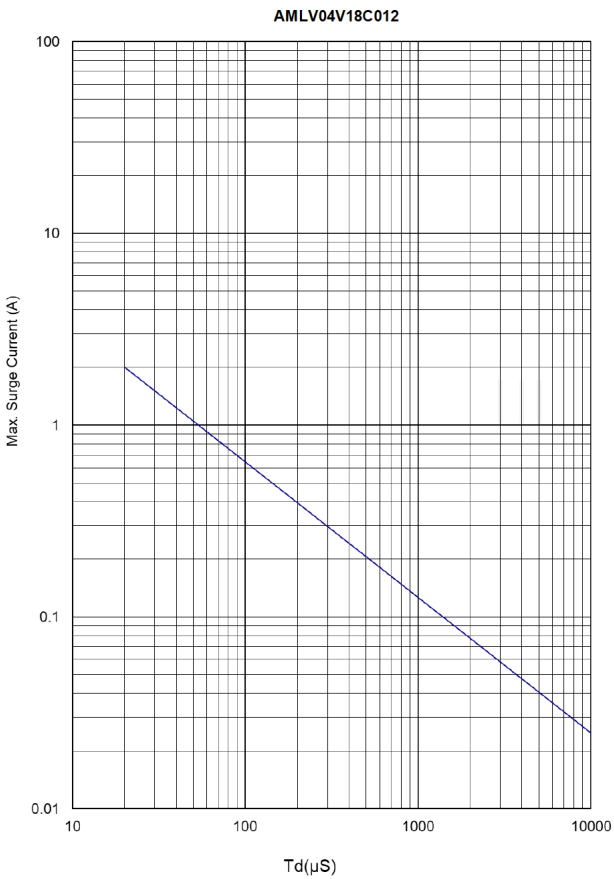
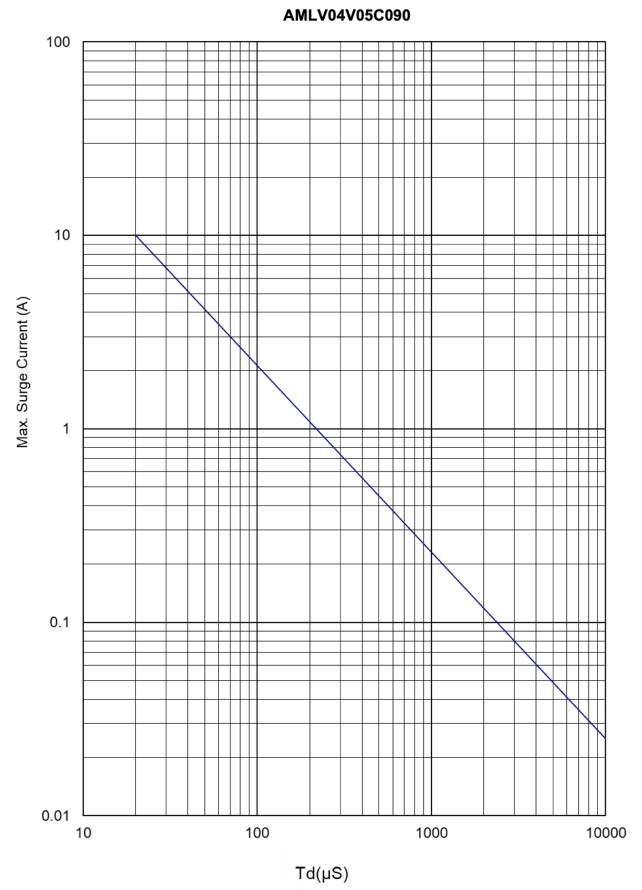
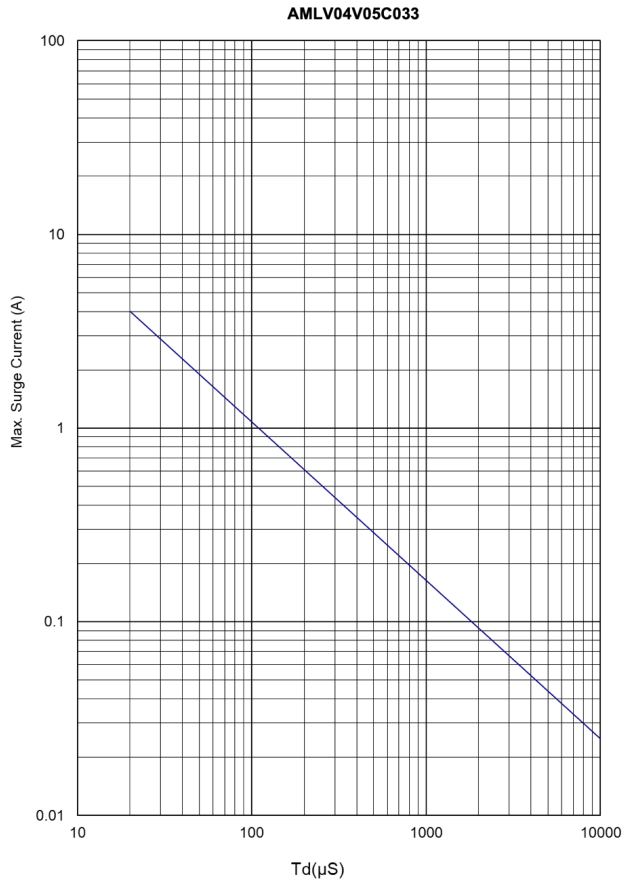

Maximum surge current derating curves

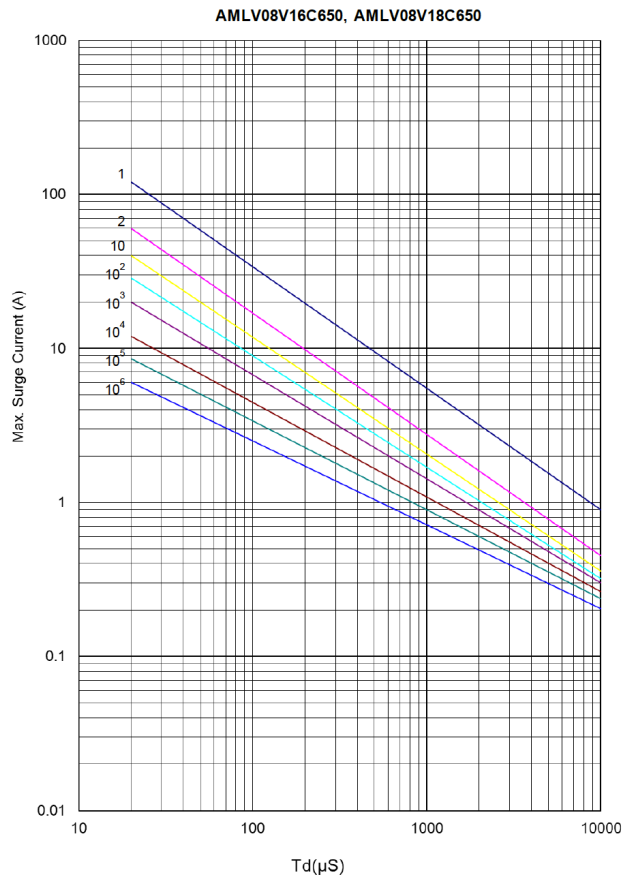
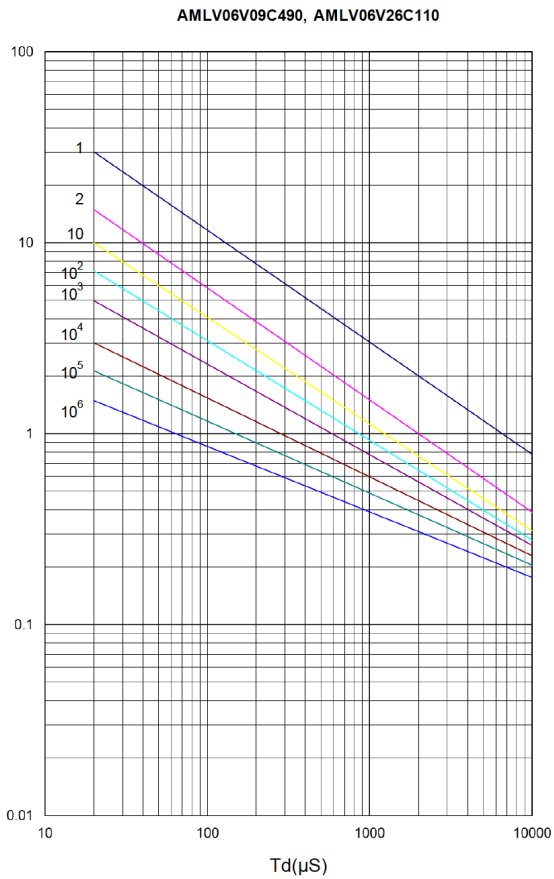
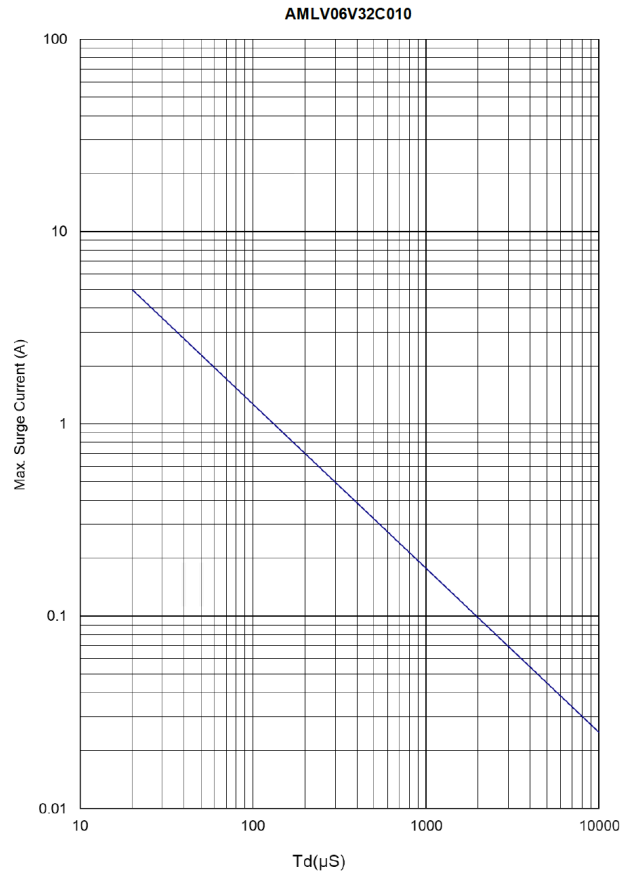
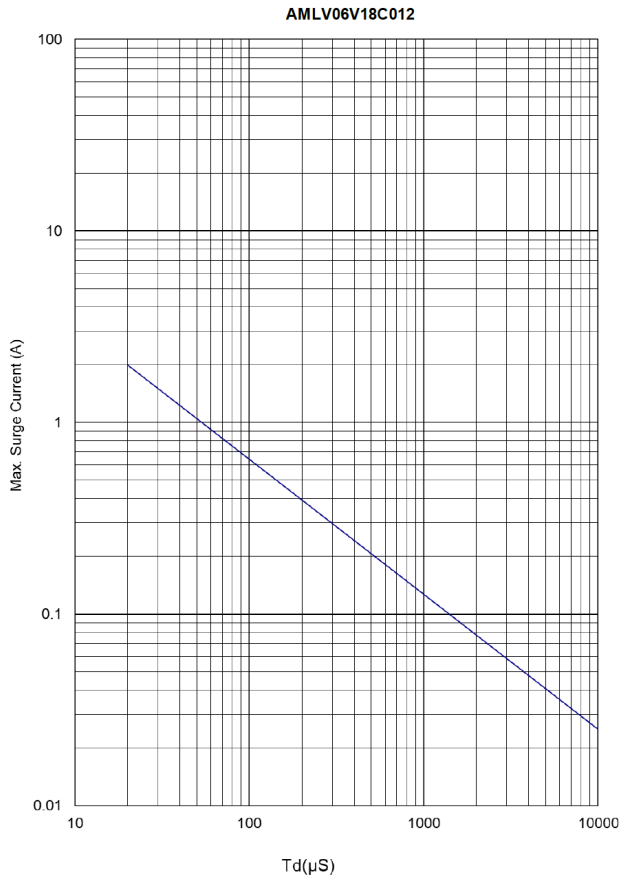

Maximum surge current derating curves

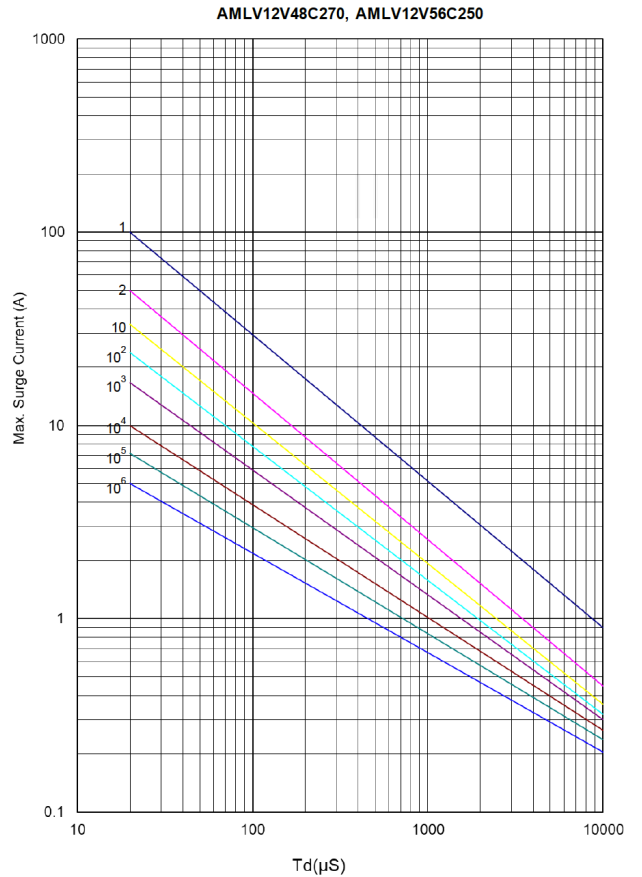
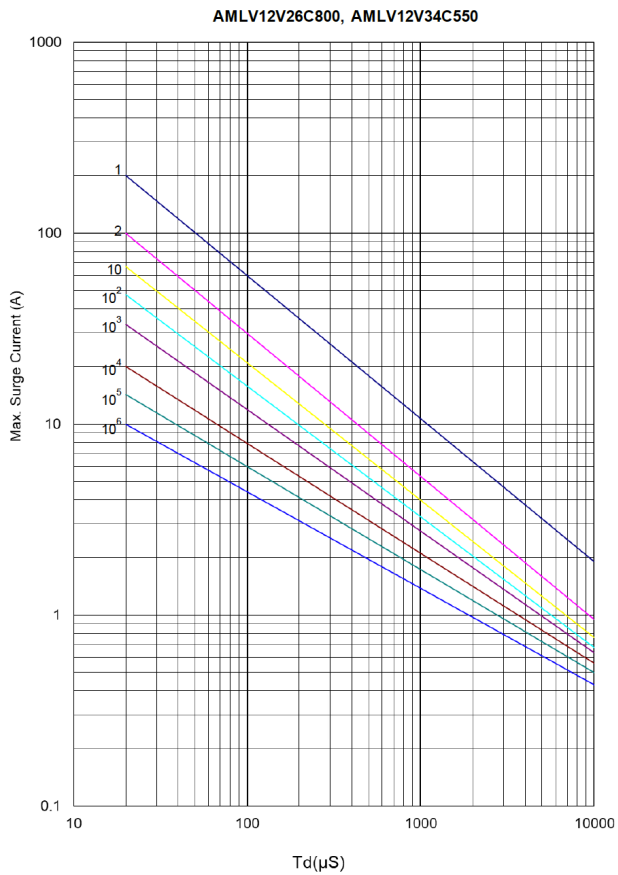
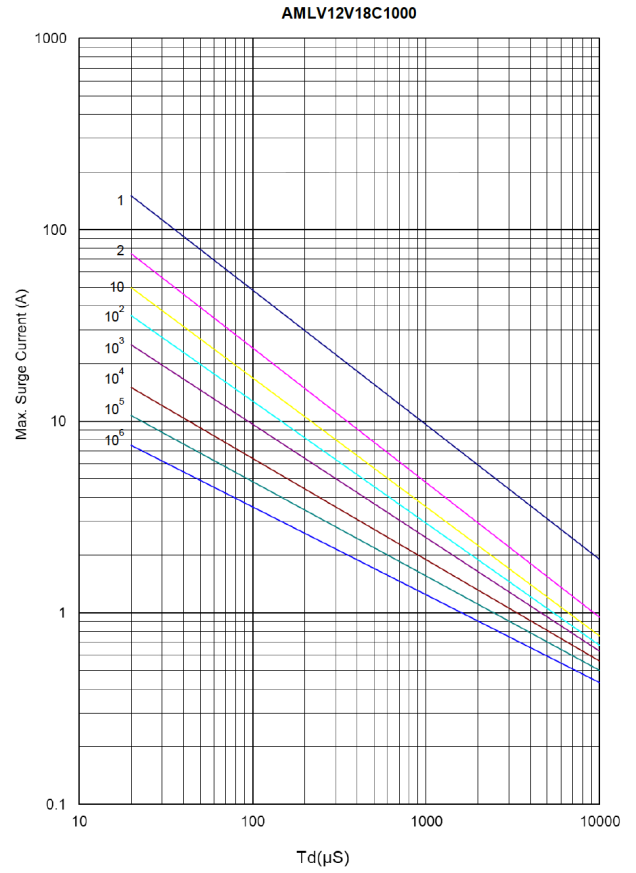
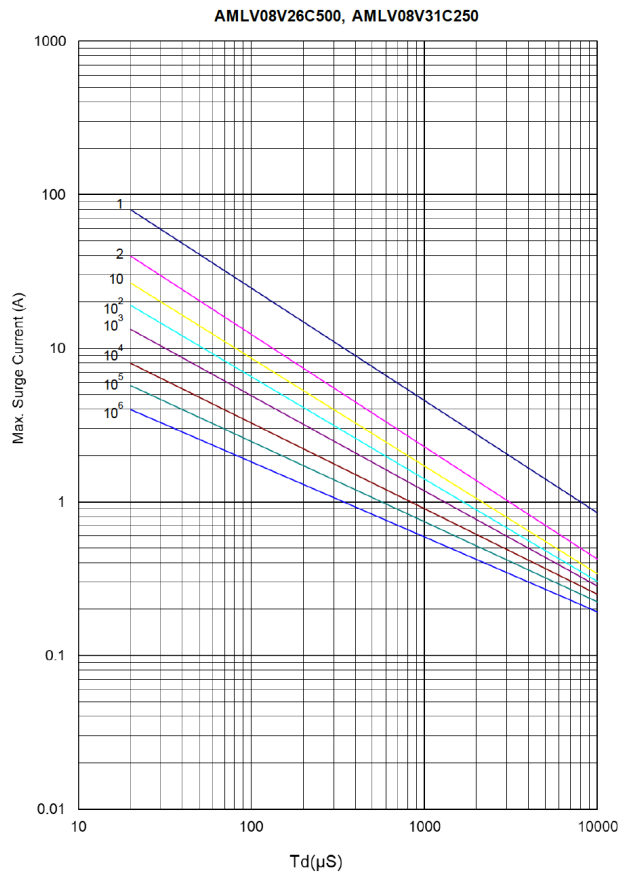

Maximum surge current derating curves

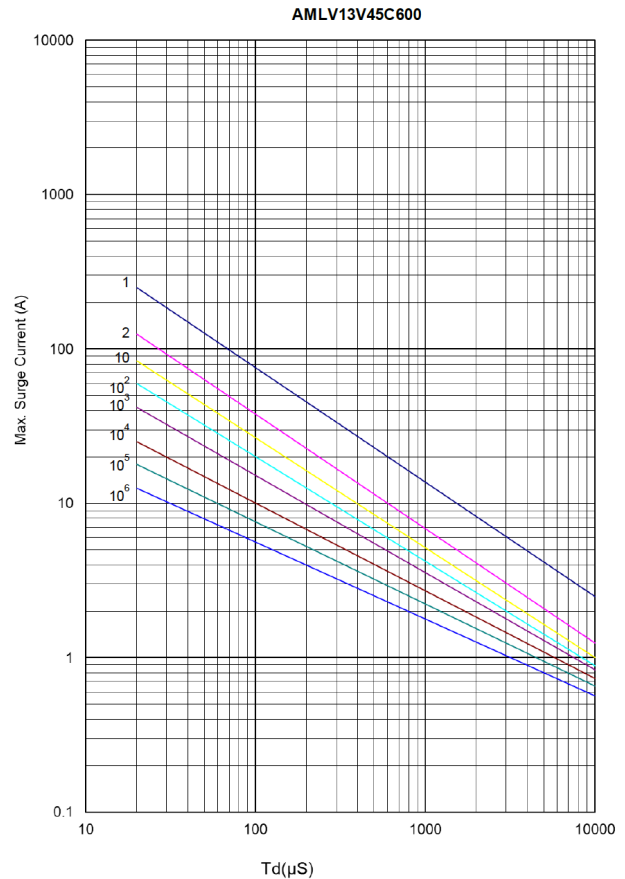
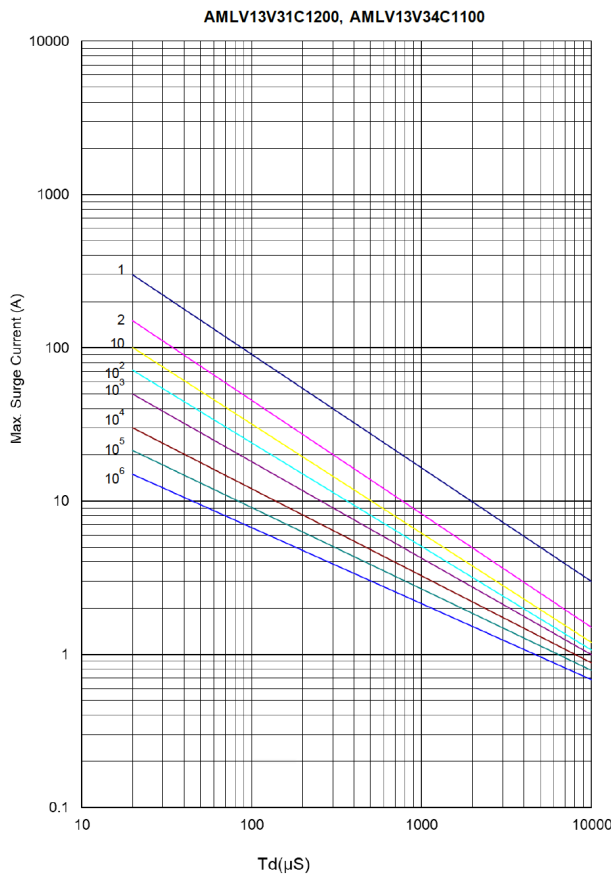
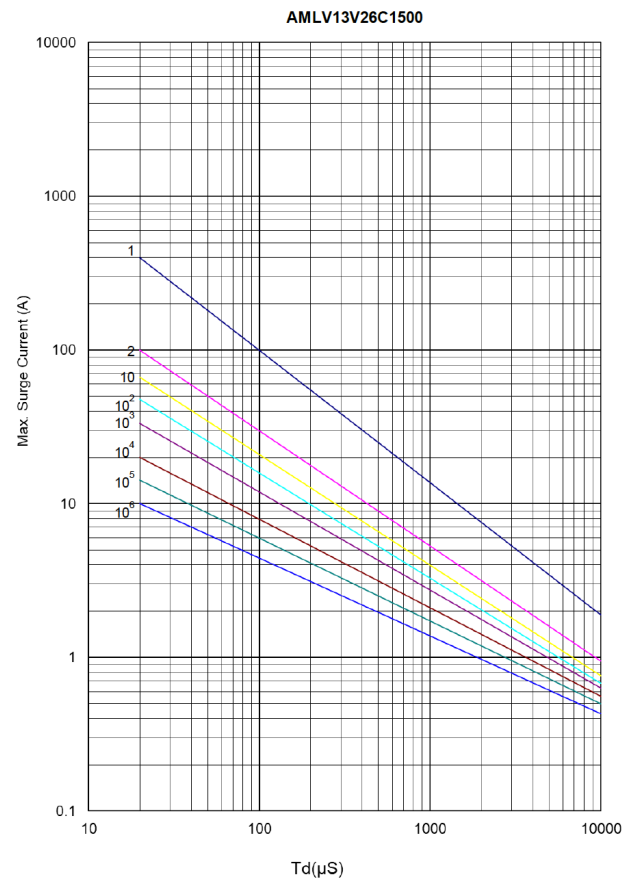
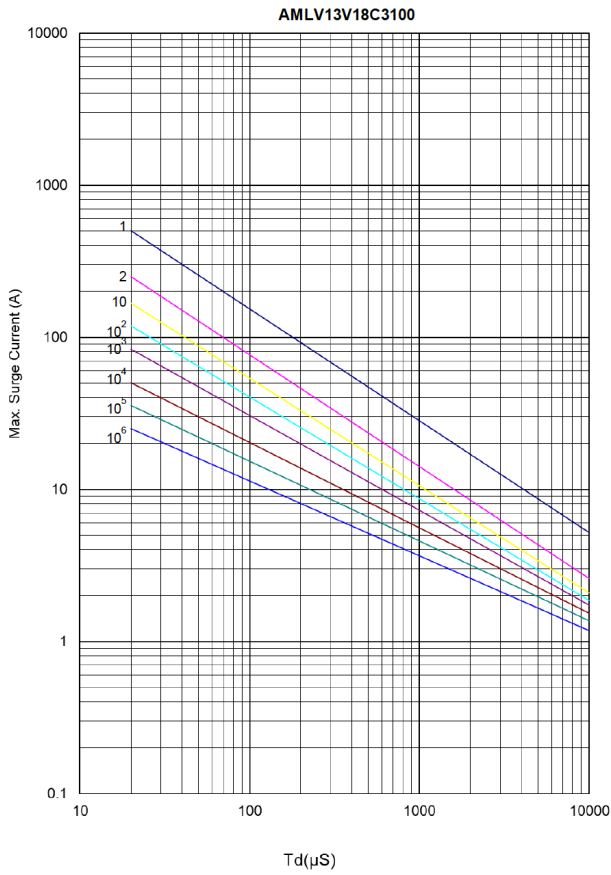

Maximum surge current derating curves

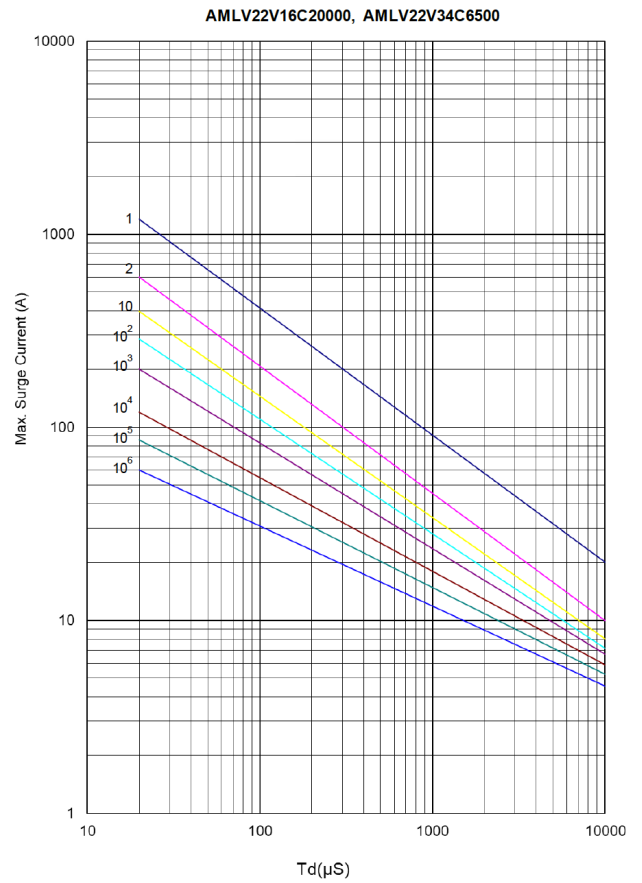
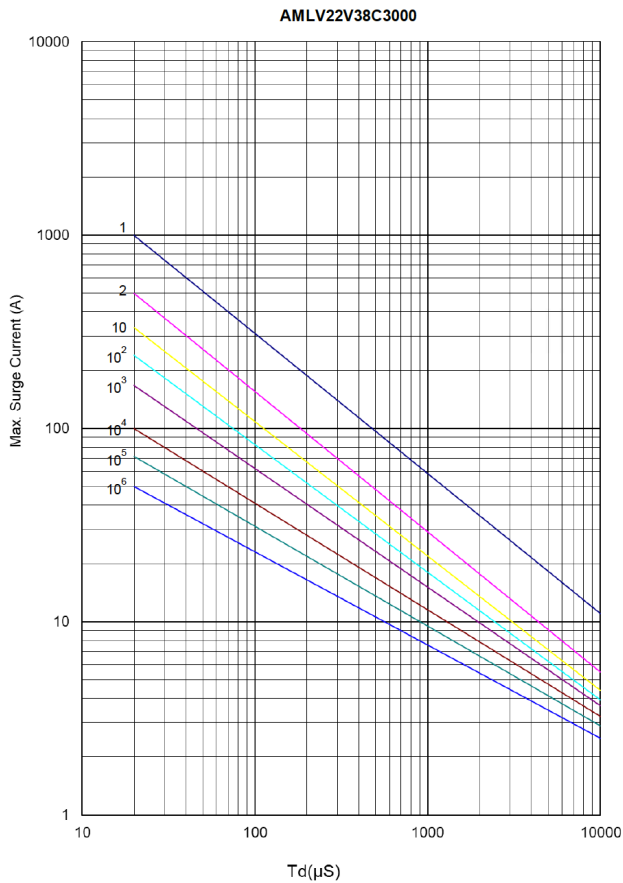
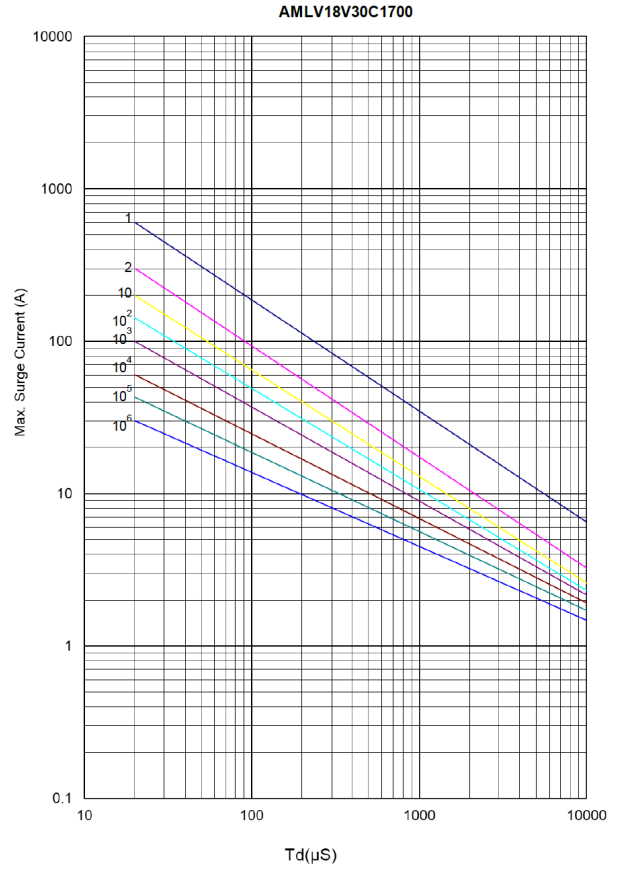
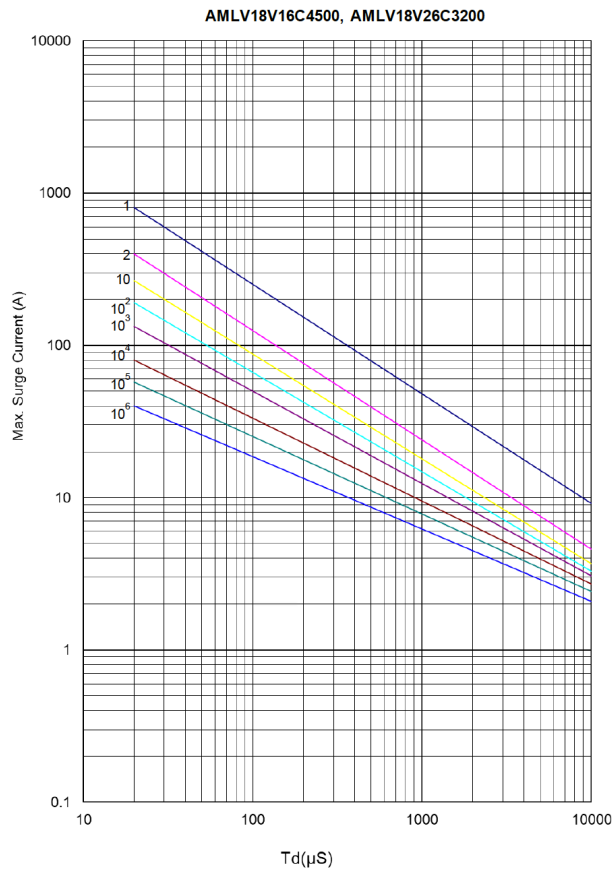

Maximum leakage current and maximum clamping voltage curves

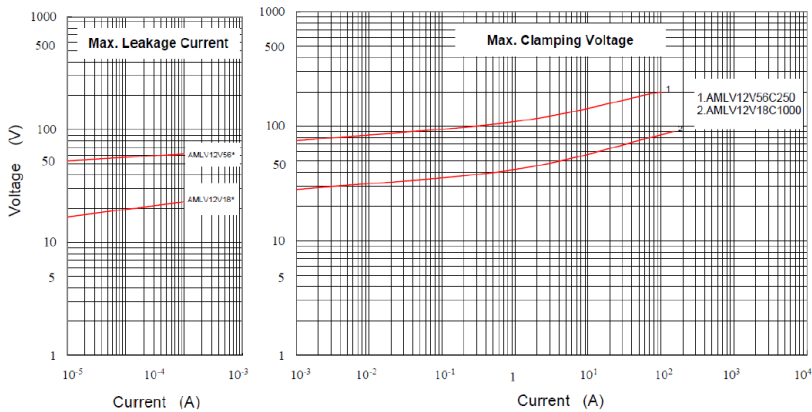
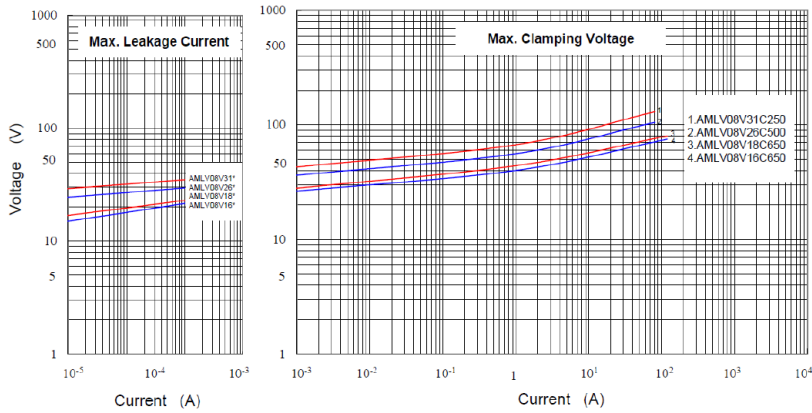
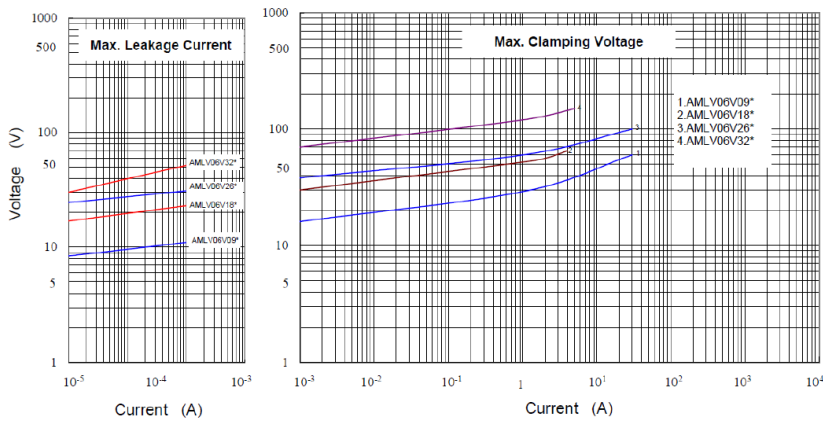
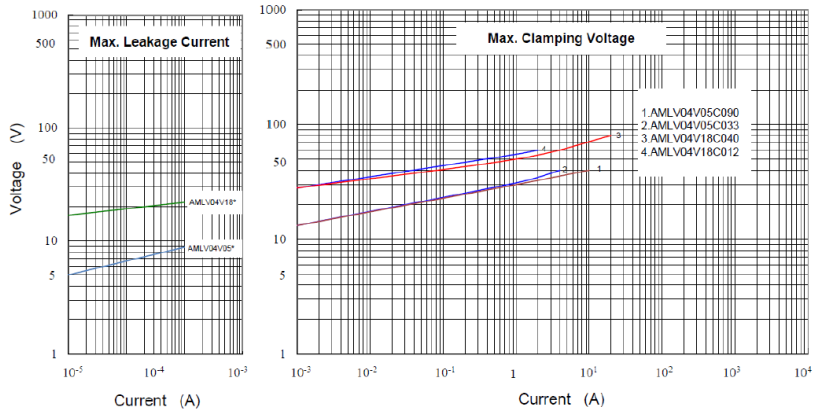

Maximum leakage current and maximum clamping voltage curves

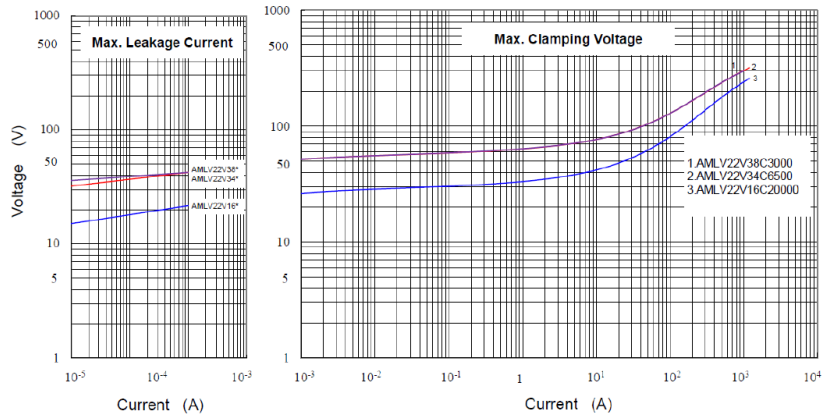
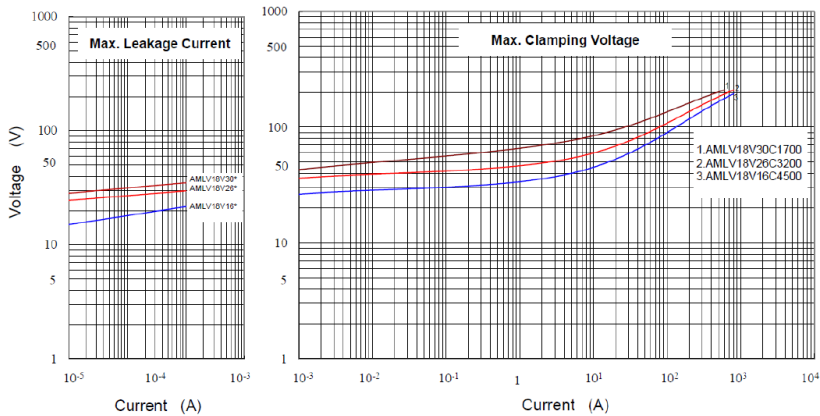
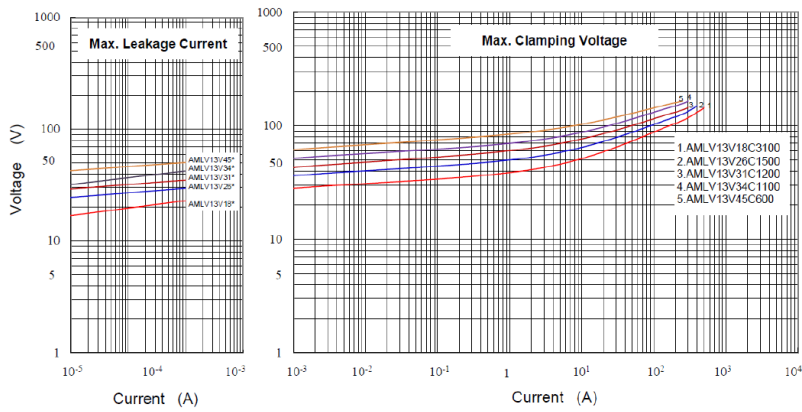
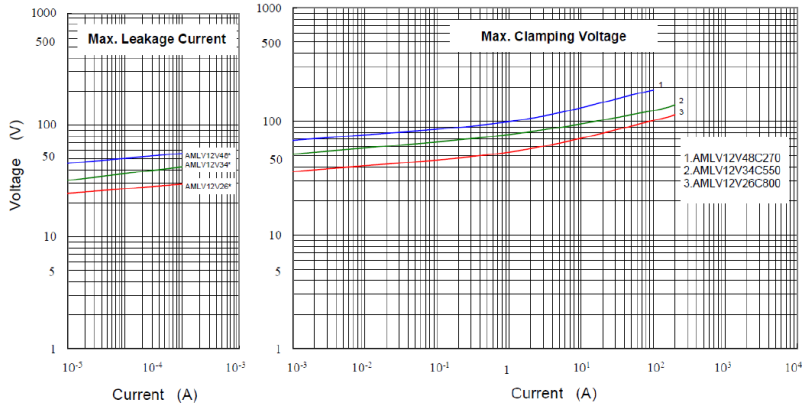

Power derating curve

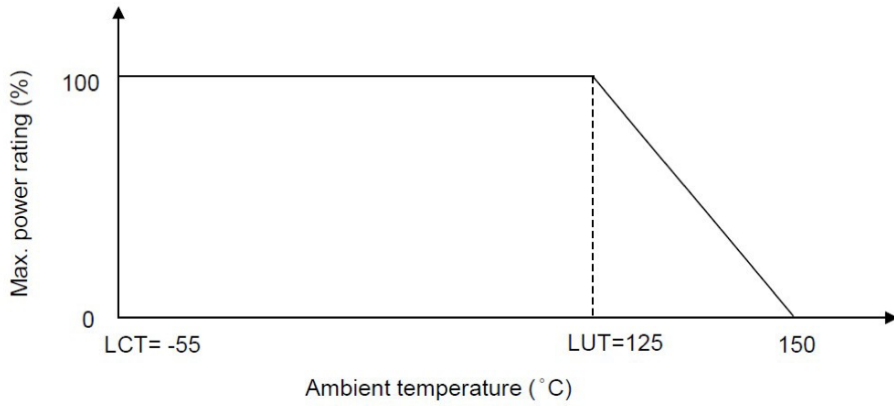

Packaging information - mm

AMLV04: 10,000 parts on a 7" diameter tape and reel (EIA-481 compliant)

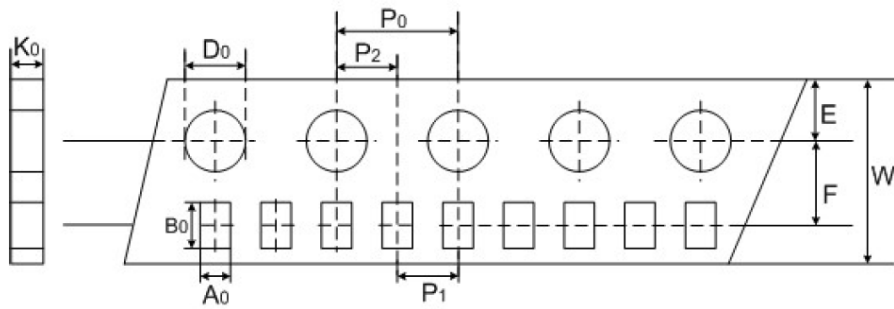

Dimension	AMLV04
A0	0.62 ± 0.05
B0	1.12 ± 0.12
W	8 ± 0.2
E	1.75 ± 0.1
F	3.5 ± 0.05
P0	4 ± 0.1
P1	2 ± 0.1
P2	2 ± 0.05
D0	1.55 ± 0.1
K0	0.60 ± 0.1

Packaging information - mm

AMLV06: 4,000 parts on a 7" diameter tape and reel (EIA-481 compliant)

AMLV08: 3,500 parts on a 7" diameter tape and reel (EIA-481 compliant)

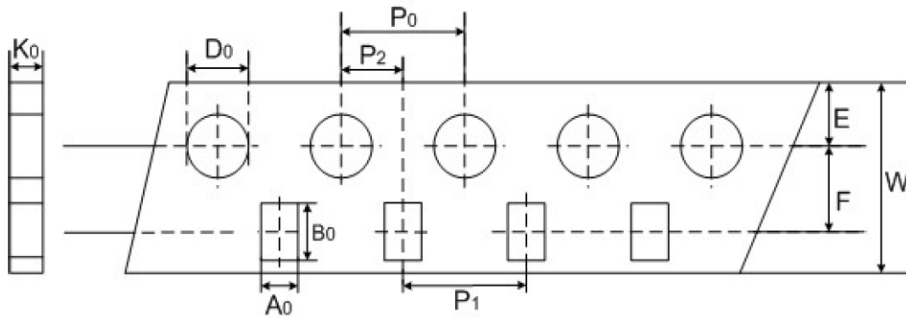

Dimension	AMLV06	AMLV08
A0	1.1 ± 0.2	1.5 ± 0.2
B0	1.9 ± 0.2	2.3 ± 0.2
W	8 ± 0.2	8 ± 0.2
E	1.75 ± 0.1	1.75 ± 0.1
F	3.5 ± 0.05	3.5 ± 0.05
P0	4 ± 0.1	4 ± 0.1
P1	4 ± 0.1	4 ± 0.1
P2	2 ± 0.05	2 ± 0.05
D0	1.55 ± 0.1	1.55 ± 0.1
K0	0.95 ± 0.1	1.00 ± 0.1

AMLV12 and AMLV13: 2500 parts on a 7" diameter tape and reel (EIA-481 compliant)

AMLV18: 1000 part on a 7" diameter tape and reel (EIA-481 compliant)

AMLV22: 800 part on a 7" diameter tape and reel (EIA-481 compliant)

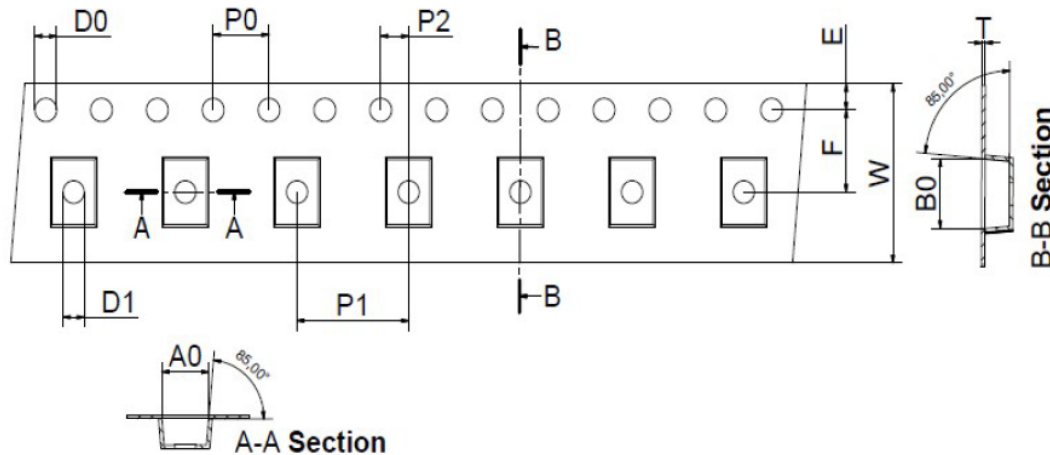

Dimension	AMLV12	AMLV13	AMLV18	AMLV22
A0	1.85 ± 0.2	2.75 ± 0.2	3.65 ± 0.2	5.50 ± 0.2
B0	3.45 ± 0.2	3.55 ± 0.2	4.96 ± 0.2	6.25 ± 0.2
W	8 ± 0.2	8 ± 0.2	12 ± 0.3	12 ± 0.3
E	1.75 ± 0.1	1.75 ± 0.1	1.75 ± 0.1	1.75 ± 0.1
F	3.5 ± 0.05	3.5 ± 0.05	5.5 ± 0.05	5.5 ± 0.05
P0	4 ± 0.1	4 ± 0.1	4 ± 0.1	4 ± 0.1
P1	4 ± 0.1	4 ± 0.1	8 ± 0.1	8 ± 0.1
P2	2 ± 0.05	2 ± 0.05	2 ± 0.05	2 ± 0.05
D0	1.55 ± 0.1	1.55 ± 0.1	1.55 ± 0.1	1.55 ± 0.1
D1	1.00 ± 0.1	1.00 ± 0.1	1.50 ± 0.1	1.50 ± 0.1
T	0.25 ± 0.1	0.25 ± 0.1	0.25 ± 0.1	0.25 ± 0.1

Solder reflow profile

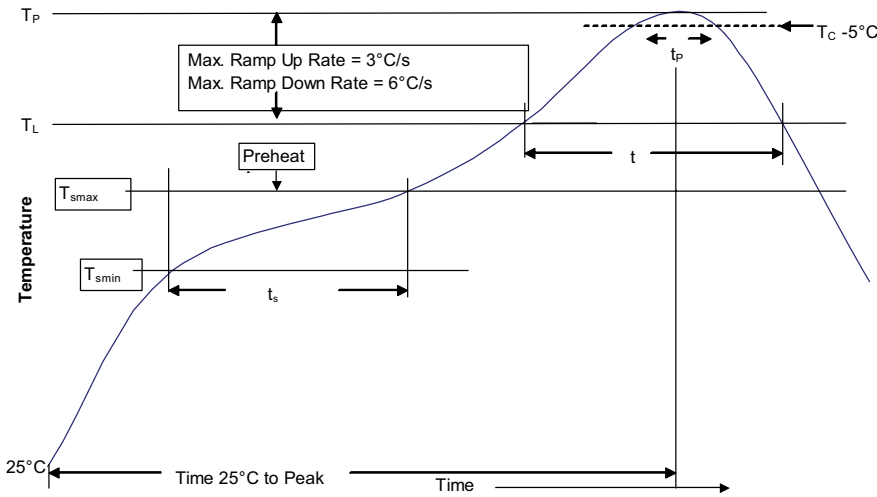

Table 1 - Standard SnPb solder (T_c)

Package thickness	Volume mm^3 <350	Volume mm^3 \geq 350
<2.5 mm)	235 °C	220 °C
\geq 2.5 mm	220 °C	220 °C

Table 2 - Lead (Pb) Free Solder (T_c)

Package thickness	Volume mm^3 <350	Volume mm^3 350 - 2000	Volume mm^3 >2000
<1.6 mm	260 °C	260 °C	260 °C
1.6 – 2.5 mm	260 °C	250 °C	245 °C
>2.5 mm	250 °C	245 °C	245 °C

Reference JDEC J-STD-020

Profile feature	Standard SnPb solder	Lead (Pb) free solder
Preheat and soak		
• Temperature min. (T_{smin})	100 °C	150 °C
• Temperature max. (T_{smax})	150 °C	200 °C
• Time (T_{smin} to T_{smax}) (t_s)	60-120 seconds	60-120 seconds
Average ramp up rate T_{smax} to T_p	3 °C/ second max.	3 °C/ second max.
Liquidous temperature (T_L)	183 °C	217 °C
Time at liquidous (t_L)	60-150 seconds	60-150 seconds
Peak package body temperature (T_p)*	Table 1	Table 2
Time (t_p)** within 5 °C of the specified classification temperature (T_c)	20 seconds**	30 seconds**
Average ramp-down rate (T_p to T_{smax})	6 °C/ second max.	6 °C/ second max.
Time 25 °C to peak temperature	6 minutes max.	8 minutes max.

* Tolerance for peak profile temperature (T_p) is defined as a supplier minimum and a user maximum.

** Tolerance for time at peak profile temperature (t_p) is defined as a supplier minimum and a user maximum.

Life Support Policy: Eaton does not authorize the use of any of its products for use in life support devices or systems without the express written approval of an officer of the Company. Life support systems are devices which support or sustain life, and whose failure to perform, when properly used in accordance with instructions for use provided in the labeling, can be reasonably expected to result in significant injury to the user.

Eaton reserves the right, without notice, to change design or construction of any products and to discontinue or limit distribution of any products. Eaton also reserves the right to change or update, without notice, any technical information contained in this bulletin.

Eaton
Electronics Division
1000 Eaton Boulevard
Cleveland, OH 44122
United States
www.eaton.com/electronics

© 2021 Eaton
All Rights Reserved
Printed in USA
Publication No. ELX1078 BU-ELX21084
August 2021

Eaton is a registered trademark.
All other trademarks are property of their respective owners.

Follow us on social media to get the latest product and support information.

