

Description

The TSV61x family of single and dual operational amplifiers offers low voltage, low power operation, and rail-to-rail input and output.

The devices also feature an ultra-low input bias current as well as a low input offset voltage.

The TSV61x have a gain bandwidth product of 120 kHz while consuming only 10 μ A at 5 V.

These features make the TSV61x family ideal for sensor interfaces, battery supplied and portable applications, as well as active filtering.

Applications

- Battery-powered applications
- Smoke detectors
- Proximity sensors
- Portable devices
- Signal conditioning
- Active filtering
- Medical instrumentation

Features

- Rail-to-rail input and output
- Low power consumption: 10 μ A typ at 5 V
- Low supply voltage: 1.5 to 5.5 V
- Gain bandwidth product: 120 kHz typ
- Unity gain stable
- Low input offset voltage: 800 μ V max (A version)
- Low input bias current: 1 pA typ
- Temperature range: -40 to 85 $^{\circ}$ C

**TSV611ILT/TSV611AILT/
TSV611AICT**

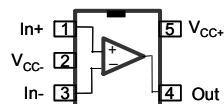

SOT23-5/SC70-5

TSV612IDT/TSV612AIDT

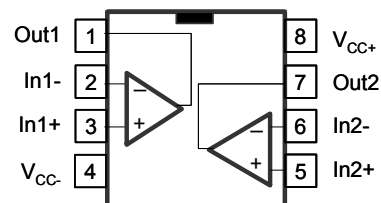

SOP-8

Absolute maximum ratings and operating conditions
Table 1. Absolute maximum ratings

Symbol	Parameter	Value	Unit
V_{CC}	Supply voltage ⁽¹⁾	6	V
V_{id}	Differential input voltage ⁽²⁾	$\pm V_{CC}$	
V_{in}	Input voltage ⁽³⁾	$(V_{CC-}) - 0.2$ to $(V_{CC+}) + 0.2$	
T_{stg}	Storage temperature	-65 to 150	$^{\circ}$ C
R_{thja}	Thermal resistance junction to ambient ^{(4) (5)}		$^{\circ}$ C/W
	SC70-5	205	
	SOT23-5	250	
	SOP8	125	
T_j	Maximum junction temperature	150	$^{\circ}$ C
ESD	HBM: human body model ⁽⁶⁾	4	kV
	MM: machine model ⁽⁷⁾	200	V
	CDM: charged device model ⁽⁸⁾	1.5	kV
	Latch-up immunity	200	mA

- All voltage values, except differential voltage are with respect to network ground terminal.
- Differential voltages are the non-inverting input terminal with respect to the inverting input terminal.
- V_{CC} - V_{in} must not exceed 6 V.
- Short-circuits can cause excessive heating and destructive dissipation.
- R_{th} are typical values.
- Human body model: 100 pF discharged through a 1.5 k Ω resistor between two pins of the device, done for all couples of pin combinations with other pins floating.
- Machine model: a 200 pF cap is charged to the specified voltage, then discharged directly between two pins of the device with no external series resistor (internal resistor < 5 Ω), done for all couples of pin combinations with other pins floating.
- Charged device model: all pins plus package are charged together to the specified voltage and then discharged directly to ground.

Table 2. Operating conditions

Symbol	Parameter	Value	Unit
V_{CC}	Supply voltage	1.5 to 5.5	V
V_{icm}	Common mode input voltage range	$(V_{CC-}) - 0.1$ to $(V_{CC+}) + 0.1$	
T_{oper}	Operating free air temperature range	-40 to 85	$^{\circ}$ C

Electrical characteristics

Table 3. Electrical characteristics at $V_{CC+} = 1.8$ V with $V_{CC-} = 0$ V, $V_{icm} = V_{CC}/2$, $T_{amb} = 25$ °C, and R_L connected to $V_{CC}/2$ (unless otherwise specified)

Symbol	Parameter	Conditions	Min.	Typ.	Max.	Unit
DC performance						
V_{io}	Offset voltage	TSV61x			4	mV
		TSV61xA			0.8	
		$T_{min.} < T_{op} < T_{max.}$ TSV61x			5	
		$T_{min.} < T_{op} < T_{max.}$ TSV61xA			2	
$\Delta V_{io}/\Delta T$	Input offset voltage drift			2		μ V/°C
I_{io}	Input offset current ($V_{out} = V_{CC}/2$)			1	10 ⁽¹⁾	pA
		$T_{min.} < T_{op} < T_{max.}$		1	100	
I_{ib}	Input bias current ($V_{out} = V_{CC}/2$)			1	10 ⁽¹⁾	pA
		$T_{min.} < T_{op} < T_{max.}$		1	100	
CMR	Common mode rejection ratio $20 \log (\Delta V_{ic}/\Delta V_{io})$	0 V to 1.8 V, $V_{out} = 0.9$ V	55	71		dB
		$T_{min.} < T_{op} < T_{max.}$	53			
A_{vd}	Large signal voltage gain	$R_L = 10$ k Ω , $V_{out} = 0.5$ V to 1.3 V	78	83		dB
		$T_{min.} < T_{op} < T_{max.}$	74			
V_{OH}	High level output voltage ($V_{OH} = V_{CC} - V_{out}$)	$R_L = 10$ k Ω $T_{min.} < T_{op} < T_{max.}$		4	35 50	mV
V_{OL}	Low level output voltage	$R_L = 10$ k Ω $T_{min.} < T_{op} < T_{max.}$		7	35 50	
I_{out}	Isink	$V_o = 1.8$ V $T_{min.} < T_{op} < T_{max.}$	9 9	13		mA
	Isource	$V_o = 0$ V $T_{min.} < T_{op} < T_{max.}$	8 8	10		
I_{CC}	Supply current (per operator)	No load, $V_{out} = V_{CC}/2$	6.5	9	12	μ A
		$T_{min.} < T_{op} < T_{max.}$	6		12.5	
AC performance						
GBP	Gain bandwidth product			100		kHz
ϕ_m	Phase margin	$R_L = 10$ k Ω , $C_L = 20$ pF		60		Degrees
G_m	Gain margin			9.5		dB
SR	Slew rate	$R_L = 10$ k Ω , $C_L = 20$ pF, $V_{out} = 0.5$ V to 1.3 V		0.03		V/ μ s

Table 3. Electrical characteristics at $V_{CC+} = 1.8$ V with $V_{CC-} = 0$ V, $V_{icm} = V_{CC}/2$, $T_{amb} = 25$ °C, and R_L connected to $V_{CC}/2$ (unless otherwise specified) (continued)

Symbol	Parameter	Conditions	Min.	Typ.	Max.	Unit
e_n	Equivalent input noise voltage	$f = 1$ kHz		110		$\frac{nV}{\sqrt{Hz}}$
THD+N	Total harmonic distortion + noise	$F_{in} = 1$ kHz, $A_v = 1$, $V_{out} = 1$ V _{pp} , $R_L = 100$ k Ω , $BW = 22$ kHz		0.07		%

1. Guaranteed by design.

Table 4. Electrical characteristics at $V_{CC+} = 3.3$ V, $V_{CC-} = 0$ V, $V_{icm} = V_{CC}/2$, $T_{amb} = 25$ °C, R_L connected to $V_{CC}/2$ (unless otherwise specified)

Symbol	Parameter		Min.	Typ.	Max.	Unit
DC performance						
V_{io}	Offset voltage	TSV61x			4	mV
		TSV61xA			0.8	
		$T_{min} < T_{op} < T_{max}$ TSV61x			5	
		$T_{min} < T_{op} < T_{max}$ TSV61xA			2	
$\Delta V_{io}/\Delta T$	Input offset voltage drift			2		μ V/°C
I_{io}	Input offset current			1	$10^{(1)}$	pA
		$T_{min} < T_{op} < T_{max}$.		1	100	
I_{ib}	Input bias current			1	$10^{(1)}$	pA
		$T_{min} < T_{op} < T_{max}$.		1	100	
CMR	Common mode rejection ratio $20 \log (\Delta V_{ic}/\Delta V_{io})$	0 V to 3.3 V, $V_{out} = 1.75$ V	61	76		dB
		$T_{min} < T_{op} < T_{max}$.	58			
A_{vd}	Large signal voltage gain	$R_L = 10$ k Ω , $V_{out} = 0.5$ V to 2.8 V	85	92		dB
		$T_{min} < T_{op} < T_{max}$.	83			
V_{OH}	High level output voltage ($V_{OH} = V_{CC} - V_{out}$)	$R_L = 10$ k Ω $T_{min} < T_{op} < T_{max}$.		5	35 50	mV
V_{OL}	Low level output voltage	$R_L = 10$ k Ω $T_{min} < T_{op} < T_{max}$.		10	35 50	
I_{out}	Isink	$V_o = V_{CC}$ $T_{min} < T_{op} < T_{max}$.	37 35	44		mA
	Isource	$V_o = 0$ V $T_{min} < T_{op} < T_{max}$.	32 30	38		
I_{CC}	Supply current (per operator)	No load, $V_{out} = V_{CC}/2$	6.5	9.5	12.5	μ A
		$T_{min} < T_{op} < T_{max}$.	6		13	
AC performance						
GBP	Gain bandwidth product			110		kHz
ϕ_m	Phase margin	$R_L = 10$ k Ω , $C_L = 20$ pF		60		Degrees
G_m	Gain margin			9.5		dB
SR	Slew rate	$R_L = 10$ k Ω , $C_L = 20$ pF, $V_{out} = 0.5$ V to 2.8V		0.035		V/ μ s
e_n	Equivalent input noise voltage	$f = 1$ kHz		110		$\frac{nV}{\sqrt{Hz}}$

1. Guaranteed by design.

Table 5. Electrical characteristics at $V_{CC+} = 5$ V, $V_{CC-} = 0$ V, $V_{icm} = V_{CC}/2$, $T_{amb} = 25$ °C, R_L connected to $V_{CC}/2$ (unless otherwise specified)

Symbol	Parameter		Min.	Typ.	Max.	Unit
DC performance						
V_{io}	Offset voltage	TSV61x			4	mV
		TSV61xA			0.8	
		$T_{min} < T_{op} < T_{max}$ TSV61x			5	
		$T_{min} < T_{op} < T_{max}$ TSV61xA			2	
$\Delta V_{io}/\Delta T$	Input offset voltage drift			2		μ V/°C
I_{io}	Input offset current			1	$10^{(1)}$	pA
		$T_{min.} < T_{op} < T_{max.}$		1	100	
I_{ib}	Input bias current			1	$10^{(1)}$	pA
		$T_{min.} < T_{op} < T_{max.}$		1	100	
CMR	Common mode rejection ratio $20 \log (\Delta V_{ic}/\Delta V_{io})$	0 V to 5 V, $V_{out} = 2.5$ V	64	80		dB
		$T_{min.} < T_{op} < T_{max.}$	63			
SVR	Supply voltage rejection ratio $20 \log (\Delta V_{cc}/\Delta V_{io})$	$V_{cc} = 1.8$ to 5 V	76	93		dB
		$T_{min.} < T_{op} < T_{max.}$	74			
A_{vd}	Large signal voltage gain	$R_L = 10$ k Ω , $V_{out} = 0.5$ V to 4.5 V	88	93		dB
		$T_{min} < T_{op} < T_{max}$	85			
V_{OH}	High level output voltage ($V_{OH} = V_{CC} - V_{out}$)	$R_L = 10$ k Ω $T_{min.} < T_{op} < T_{max.}$		7	35 50	mV
V_{OL}	Low level output voltage	$R_L = 10$ k Ω $T_{min.} < T_{op} < T_{max.}$		16	35 50	
I_{out}	Isink	$V_o = V_{CC}$ $T_{min.} < T_{op} < T_{max.}$	52 42	57		mA
	Isource	$V_o = 0$ V $T_{min.} < T_{op} < T_{max.}$	58 49	63		
I_{CC}	Supply current (per operator)	No load, $V_{out} = V_{CC}/2$	7.5	10.5	14	μ A
		$T_{min.} < T_{op} < T_{max.}$	7		15	
AC performance						
GBP	Gain bandwidth product			120		kHz
ϕ_m	Phase margin	$R_L = 10$ k Ω , $C_L = 20$ pF		62		Degrees
G_m	Gain margin			10		dB
SR	Slew rate	$R_L = 10$ k Ω , $C_L = 20$ pF, $V_{out} = 0.5$ V to 4.5V		0.04		V/ μ s

Table 5. Electrical characteristics at $V_{CC+} = 5$ V, $V_{CC-} = 0$ V, $V_{icm} = V_{CC}/2$, $T_{amb} = 25$ °C, R_L connected to $V_{CC}/2$ (unless otherwise specified) (continued)

Symbol	Parameter		Min.	Typ.	Max.	Unit
e_n	Equivalent input noise voltage	$f = 1$ kHz		105		$\frac{nV}{\sqrt{Hz}}$
THD+N	Total harmonic distortion + noise	$F_{in} = 1$ kHz, $A_v = 1$, $V_{out} = 1$ V _{pp} , $R_L = 100$ k Ω , BW = 22kHz		0.02		%

1. Guaranteed by design.

Figure 1. Supply current vs. supply voltage at $V_{icm} = V_{CC}/2$

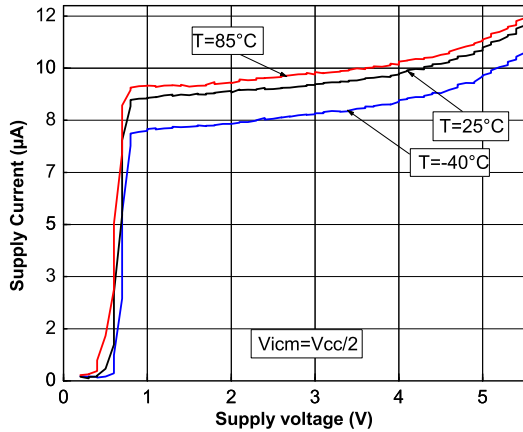

Figure 2. Output current vs. output voltage at $V_{CC} = 1.5$ V

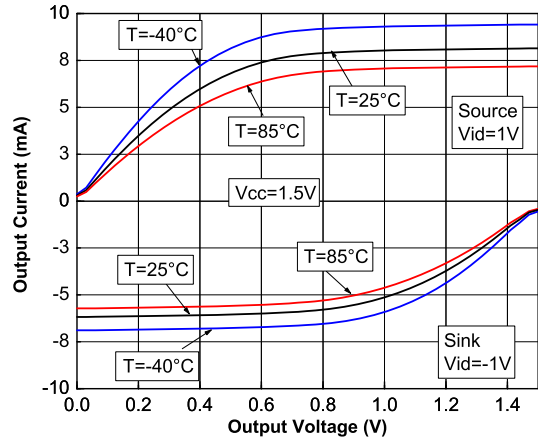

Figure 3. Output current vs. output voltage at $V_{CC} = 5$ V

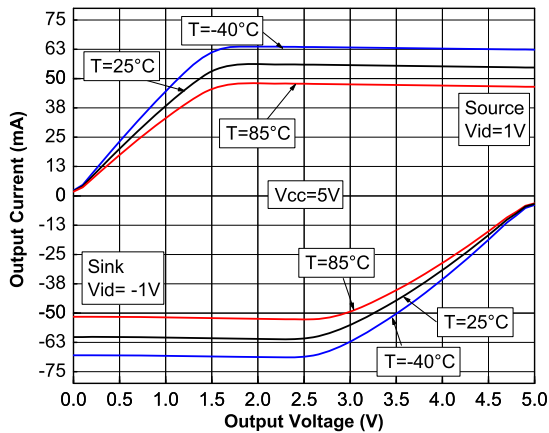

Figure 4. Voltage gain and phase vs. frequency at $V_{CC} = 1.5$ V

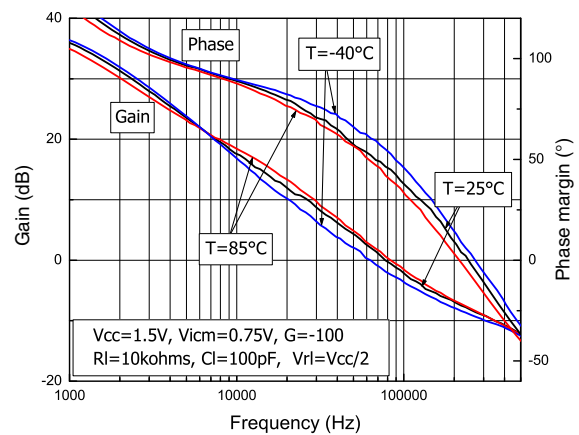

Figure 5. Voltage gain and phase vs. frequency at $V_{CC} = 5$ V

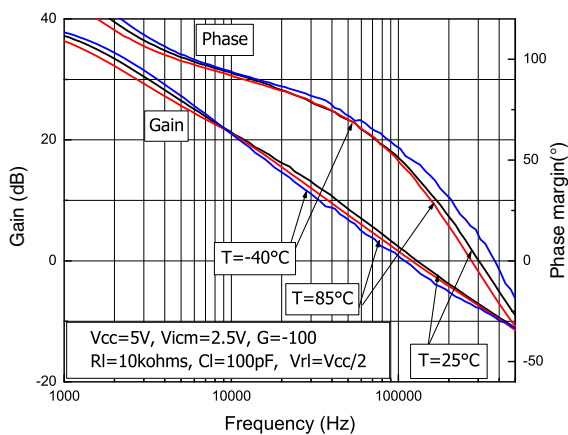
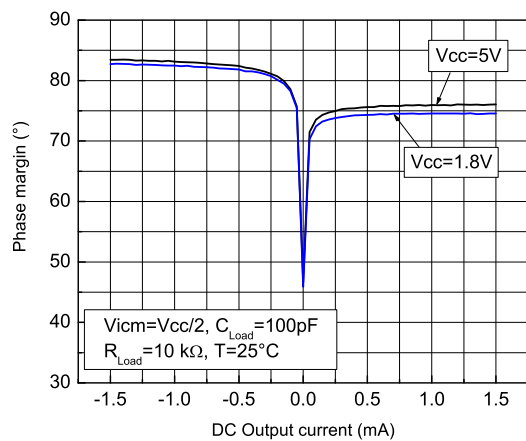

Figure 6. Phase margin vs. output current



Rail-to-rail input/output 10 μ A, 120 kHz CMOS operational amplifiers

Figure 7. Positive slew rate vs. time, $V_{CC} = 1.5$ V, $C_{Load} = 100$ pF, $R_{Load} = 10$ k Ω

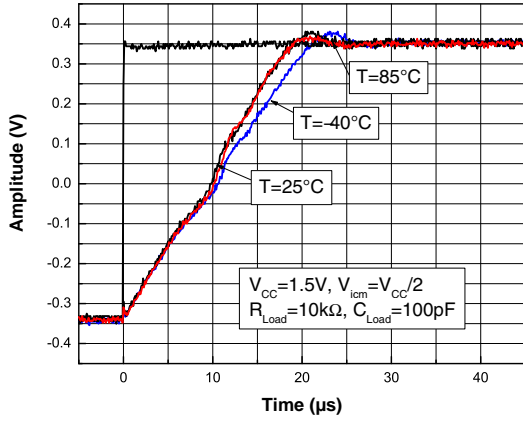

Figure 8. Negative slew rate vs. time, $V_{CC} = 1.5$ V, $C_{Load} = 100$ pF, $R_{Load} = 10$ k Ω

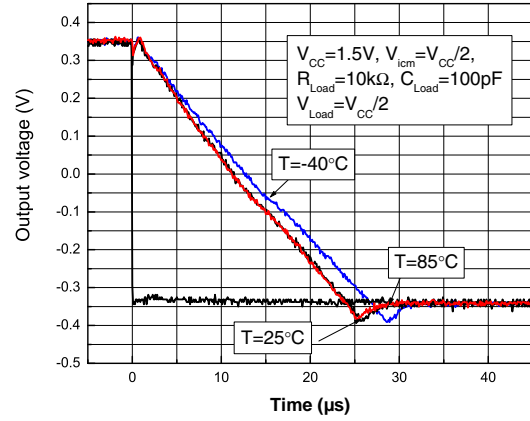

Figure 9. Positive slew rate vs. time, $V_{CC} = 5.5$ V, $C_{Load} = 100$ pF, $R_{Load} = 100$ k Ω

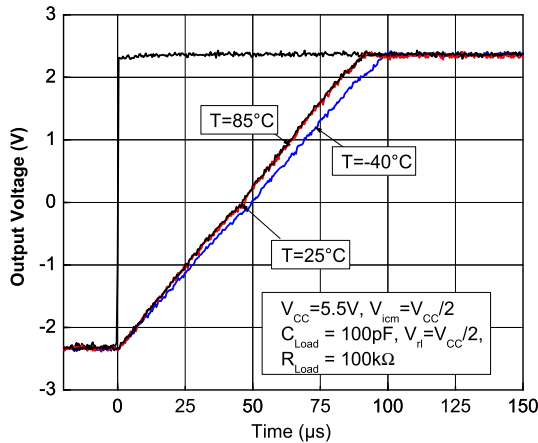

Figure 10. Negative slew rate vs. time, $V_{CC} = 5.5$ V, $C_{Load} = 100$ pF, $R_{Load} = 100$ k Ω

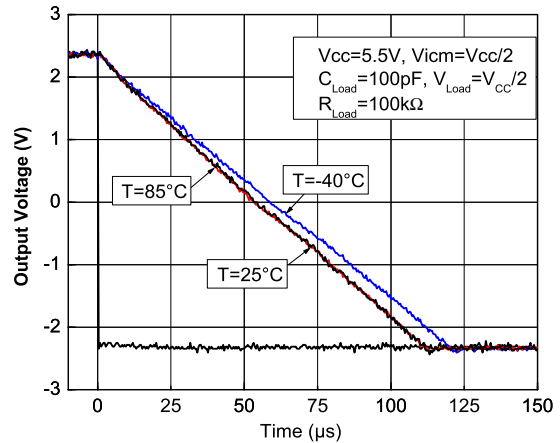

Figure 11. Slew rate vs. supply voltage

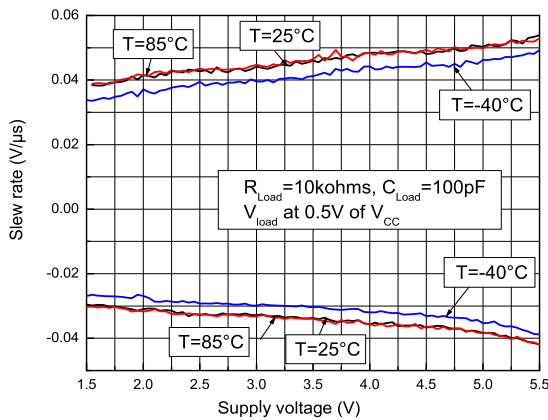

Figure 12. Noise vs. frequency at $V_{CC} = 5$ V

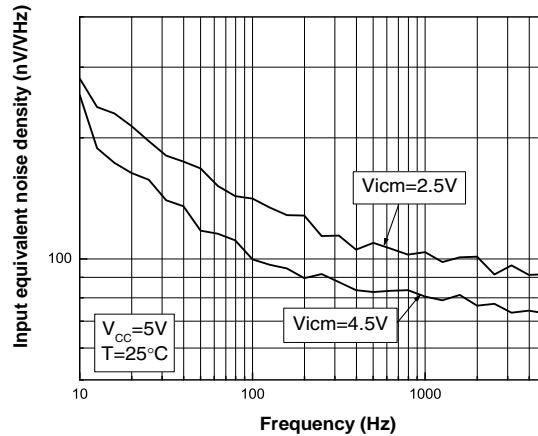

Figure 13. Distortion + noise vs. frequency

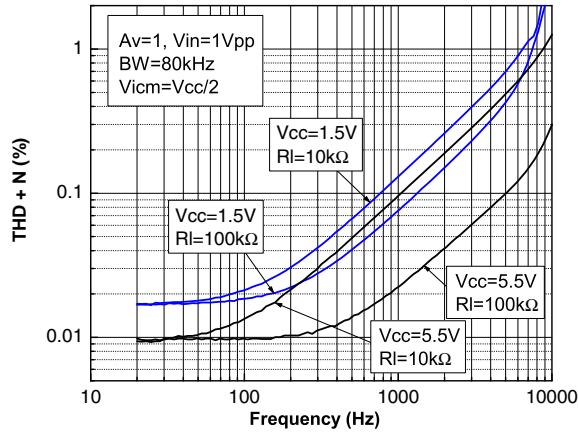

Figure 14. Distortion + noise vs. output voltage

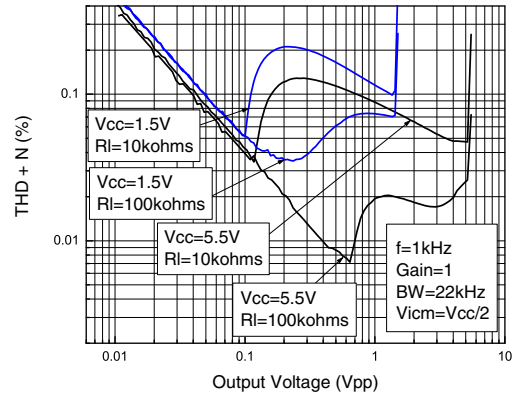

Figure 15. Voltage gain and phase vs. frequency at $V_{CC} = 1.8$ V (based on simulation results)

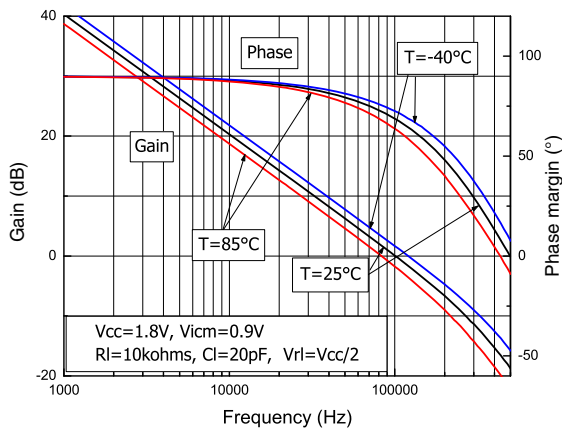

Figure 16. Voltage gain and phase vs. frequency at $V_{CC} = 5$ V (based on simulation results)

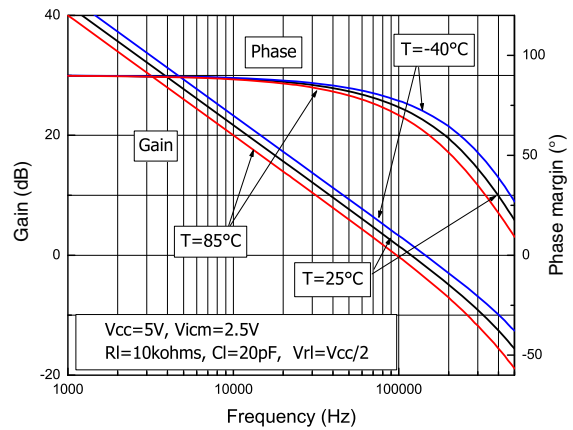
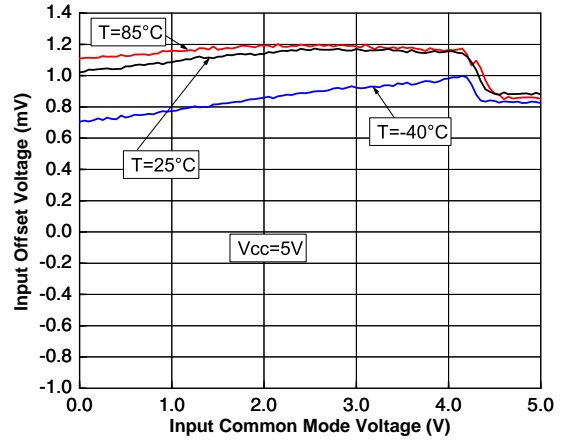
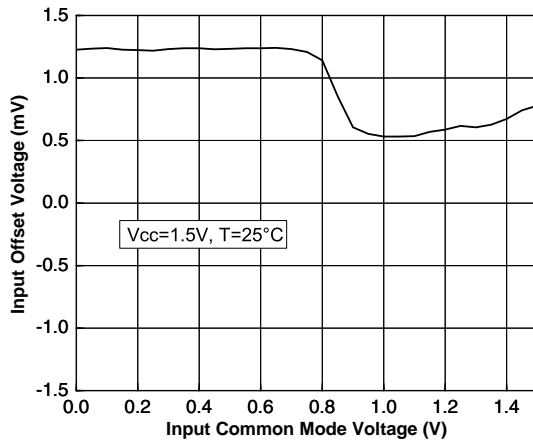

Figure 17. Input offset voltage vs input common mode at $V_{CC} = 1.5$ V Figure 18. Input offset voltage vs input common mode at $V_{CC} = 5$ V



The device is guaranteed without phase reversal.

Package Dimension

SOP-8

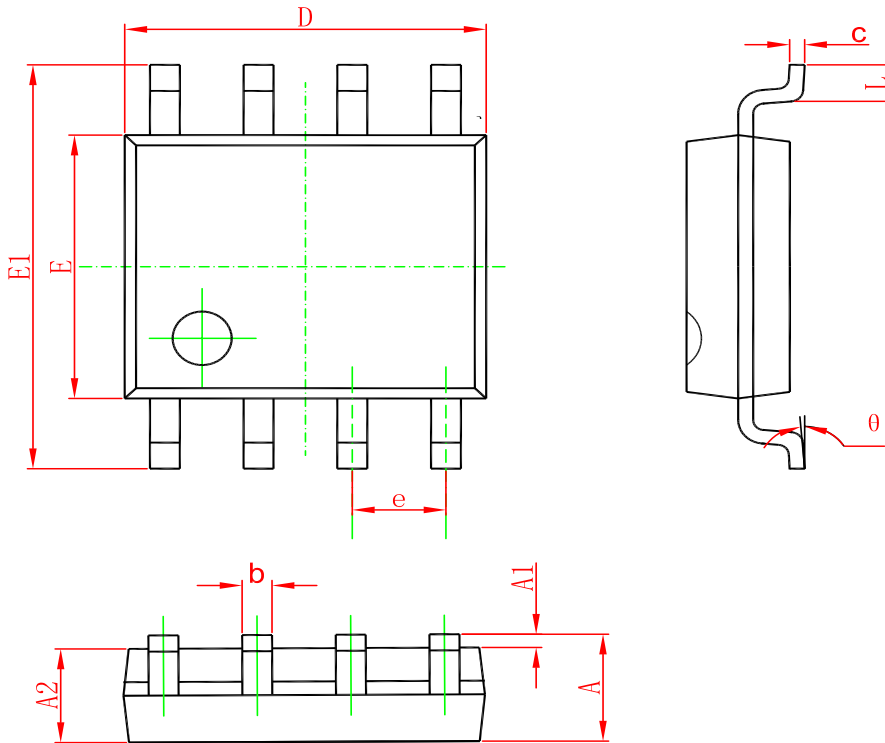

Symbol	Dimensions In Millimeters		Dimensions In Inches	
	Min	Max	Min	Max
A	1.350	1.750	0.053	0.069
A1	0.100	0.250	0.004	0.010
A2	1.350	1.550	0.053	0.061
b	0.330	0.510	0.013	0.020
c	0.170	0.250	0.006	0.010
D	4.700	5.100	0.185	0.200
E	3.800	4.000	0.150	0.157
E1	5.800	6.200	0.228	0.244
e	1.270(BSC)		0.050(BSC)	
L	0.400	1.270	0.016	0.050
θ	0°	8°	0°	8°

SC70-5 (SOT353)

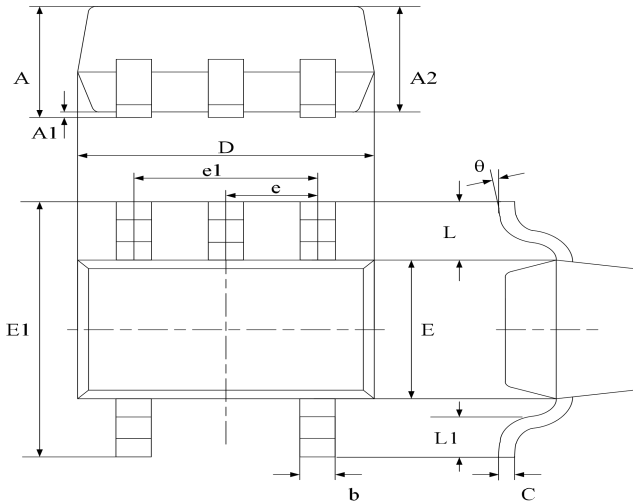

Symbol	Dimensions In Millimeters		Dimensions In Inches	
	Min	Max	Min	Max
A	0.800	1.100	0.035	0.043
A1	0.000	0.100	0.000	0.004
A2	0.800	0.900	0.035	0.039
b	0.150	0.350	0.006	0.014
C	0.080	0.150	0.003	0.006
D	1.8500	2.150	0.079	0.087
E	1.100	1.400	0.045	0.053
E1	1.950	2.200	0.085	0.096
e	0.850 typ.		0.026 typ.	
e1	1.200	1.400	0.047	0.055
L	0.42 ref.		0.021 ref.	
L1	0.260	0.460	0.010	0.018
θ	0°	8°	0°	8°

SOT23-5

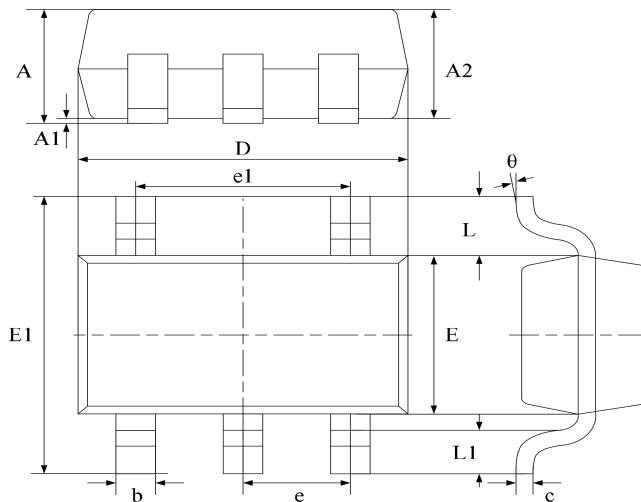

Symbol	Dimensions In Millimeters		Dimensions In Inches	
	Min	Max	Min	Max
A	1.040	1.350	0.042	0.055
A1	0.040	0.150	0.002	0.006
A2	1.000	1.200	0.041	0.049
b	0.380	0.480	0.015	0.020
c	0.110	0.210	0.004	0.009
D	2.720	3.120	0.111	0.127
E	1.400	1.800	0.057	0.073
E1	2.600	3.000	0.106	0.122
e	0.950 typ.		0.037 typ.	
e1	1.900 typ.		0.078 typ.	
L	0.700 ref.		0.028 ref.	
L1	0.300	0.600	0.012	0.024
θ	0°	8°	0°	8°

Ordering information

Order code	Package	Baseqty	Deliverymode	Marking
UMW TSV611ILT	SOT23-5	3000	Tape and reel	K12 U
UMW TSV611AILT	SOT23-5	3000	Tape and reel	K11 U
UMW TSV611AICT	SC70-5	3000	Tape and reel	K11 U
UMW TSV612IDT	SOP-8	2500	Tape and reel	V612I
UMW TSV612AIDT	SOP-8	2500	Tape and reel	V612AI