

SERIES: PS02 | **DESCRIPTION:** PRESSURE SENSOR

FEATURES

- temperature compensated
- multiple pressure range options
- absolute, gauge and sealed pressure options
- stainless steel housing
- o-ring seal
- digital output

SPECIFICATIONS

| parameter | conditions/description | min | typ | max | units |
|--------------------------------|--|----------|-----------|----------|----------|
| pressure range | see Pressure Specifications for more details | 0 | | 6 | MPa |
| pressure reference | gauge pressure, absolute pressure, sealed gauge pressure | | | | |
| excitation | | 3.1 | 3.3 | 3.6 | V |
| current consumption | standby current working current | | | 0.1 3 | mA mA |
| output signal | I ² C (14 bit) | | | | |
| I ² C slave address | 0x060 | | | | |
| data ready time | | | | 2 | ms |
| response time | | | | 3 | ms |
| zero output | at 10% - 90% | | 666 | | C hex |
| span output | at 10% - 90% | | 3,999 | | C hex |
| insulation resistance | at 250 Vdc | 200 | | | MΩ |
| vibration | 20 G (20-5,000 Hz) | | | | |
| shock | 100 G for 10 ms | | | | |
| compensated temperature | <100 kPa models all other models | 0 -20 | | 60 85 | °C °C |
| operating temperature | | -40 | | 105 | °C |
| storage temperature | | -40 | | 125 | °C |
| life | | | 1,000,000 | | cycles |
| RoHS | yes | | | | |

MECHANICAL

| parameter | conditions/description | min | typ | max | units |
|-------------------|---------------------------------------|-----|-----|-----|-------|
| measured medium | all 316L compatible liquids and gases | | | | |
| housing/diaphragm | stainless steel 316L | | | | |
| dimensions | Ø19 x 14 | | | | mm |
| weight | | 19 | | 25 | g |

BASIC PARAMETERS

| parameter | conditions/description | min | typ | max | units |
|-------------------------------------|------------------------|-----|-------|------|----------|
| accuracy ¹ | | | ±0.5 | | %FS |
| hysteresis | | | ±0.05 | ±0.1 | %FS |
| repeatability | | | ±0.05 | ±0.1 | %FS |
| zero temperature drift ¹ | | | ±1.0 | ±1.5 | %FS |
| span temperature drift ¹ | | | ±1.0 | ±1.5 | %FS |
| thermal hysteresis | | | ±0.05 | ±0.2 | %FS |
| long term stability | | | ±0.25 | | %FS/year |

Note: 1. In the compensation temperature range, refer to 25°C.

PRESSURE SPECIFICATIONS

| pressure range | pressure reference ² | overload pressure | burst pressure |
|----------------|---------------------------------|-------------------|----------------|
| 0~35 kPa | G | 300%FS | 400%FS |
| 0~100 kPa | G, A | 200%FS | 300%FS |
| 0~250 kPa | G | 200%FS | 300%FS |
| 0~600 kPa | G | 200%FS | 300%FS |
| 0~1.0 MPa | G | 200%FS | 300%FS |
| 0~1.6 MPa | G, S | 200%FS | 300%FS |
| 0~2.5 MPa | G, S | 200%FS | 300%FS |
| 0~4.0 MPa | S | 200%FS | 300%FS |
| 0~6.0 MPa | S | 200%FS | 300%FS |

Note: 2. A=absolute pressure (vacuum is zero); G=gauge pressure (current atmospheric pressure as zero); S=sealed gauge pressure (calibrated atmospheric pressure is zero).

PART NUMBER KEY

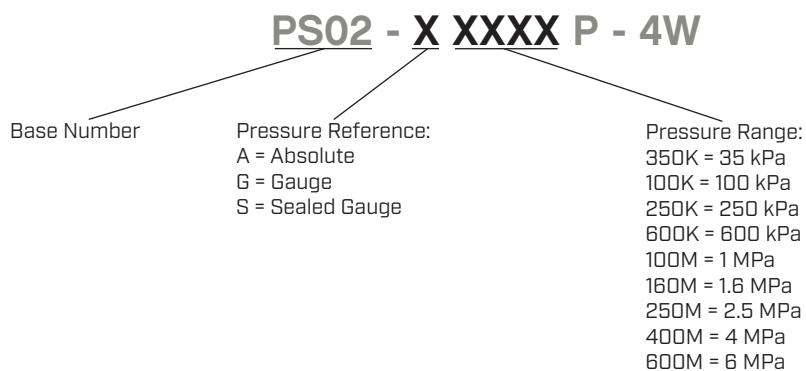

MECHANICAL DRAWING

units: mm
 tolerance: ± 0.1 mm
 unless otherwise noted

| ITEM | DESCRIPTION | MATERIAL | PLATING/COLOR |
|------|-------------|---|---------------|
| A | housing | SS 316L | |
| B | diaphragm | SS 316L | |
| C | oil filling | silicon oil | |
| D | o-ring | NBR | black |
| E | wires | silicon; OD: 1.4 mm; 0.15 mm ² | |

| WIRE CONNECTIONS | |
|------------------|----------|
| Wire Color | Function |
| Red | VDD |
| Blue | GND |
| Yellow | SCL |
| White | SDA |

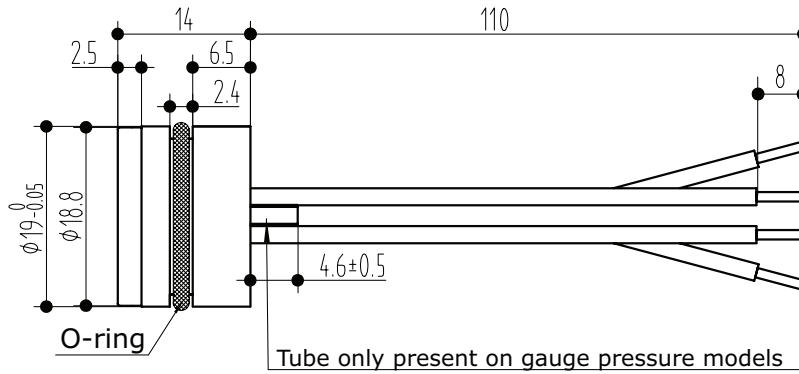

INTERFACE DIAGRAM

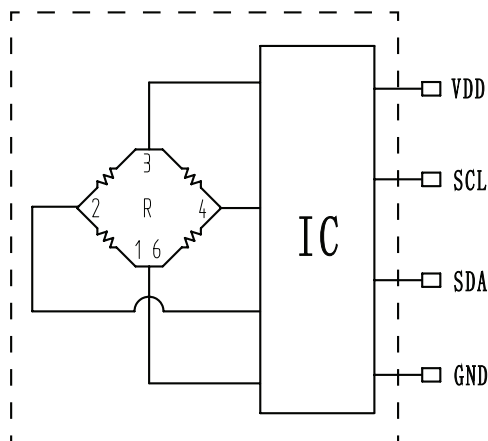

I²C OPERATION

Command Request

I²C slave address: 0x06D

Pressure Command: 0x06

Temperature Command: 0x09

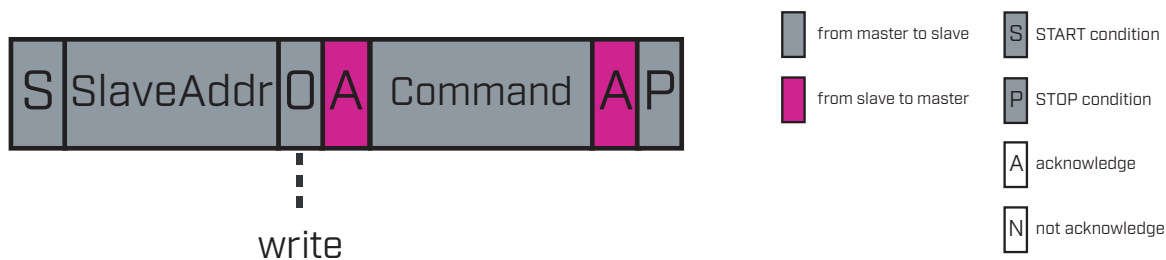

Read Data

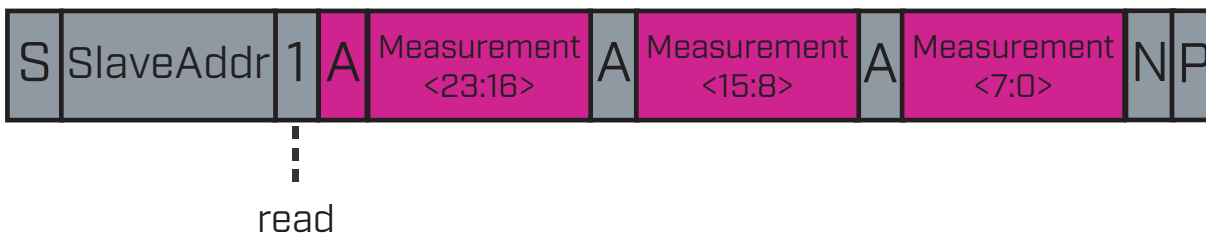

Steps to read data from PS02 sensor

1. Write the corresponding command to the sensor (0x06 for pressure, 0x09 for temperature).
2. Read three bytes from the sensor.
3. Combine these three bytes into a single 24-bit value.
4. Convert the 24-bit value to a standard pressure or temperature unit using the formulas below.

Convert Pressure Value

$$\text{Pressure (kPa)} = P_{\text{max}} / 0.8 * (x / 2^{23} - 0.1)$$

Convert Temperature Value

$$\text{For } x < 2^{23}: \text{Temperature } [^{\circ}\text{C}] = x / 2^{16} + 25$$

$$\text{For } x \geq 2^{23}: \text{Temperature } [^{\circ}\text{C}] = (x - 2^{24}) / 2^{16} + 25$$

I²C TIMING CHARACTERISTICS

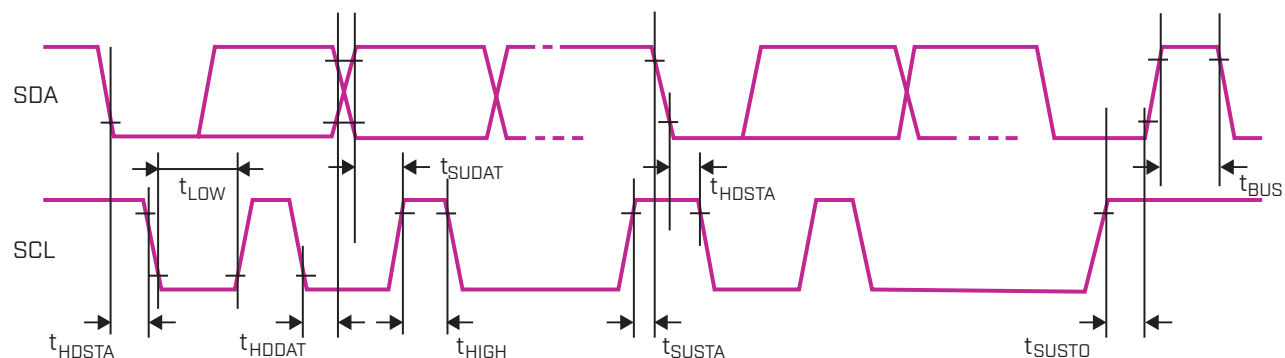

| Specification | Symbol | Min | Typical | Max | Unit |
|--|--------------------|-----|---------|-----|------|
| SCL clock frequency | f _{SCL} | 100 | -- | 400 | kHz |
| Start condition hold time relative to SCL edge | t _{HDSTA} | -- | 0.6 | -- | μs |
| Minimum SCL clock low width | t _{LOW} | -- | 1.3 | -- | μs |
| Minimum SCL clock high width | t _{HIGH} | -- | 0.6 | -- | μs |
| Start condition setup time relative to SCL edge | t _{SUSTA} | -- | 0.6 | -- | μs |
| Data hold time on SDA relative to SCL edge | t _{HDDAT} | -- | 0.6 | -- | μs |
| Data setup time on SDA relative to SCL edge | t _{SUDAT} | -- | 0.1 | -- | μs |
| Stop condition setup time on SCL | t _{SUSTO} | -- | 0.6 | -- | μs |
| Bus free time between stop condition and start condition | t _{BUS} | -- | 1.3 | -- | μs |

PRESSURE TRANSFER FUNCTION

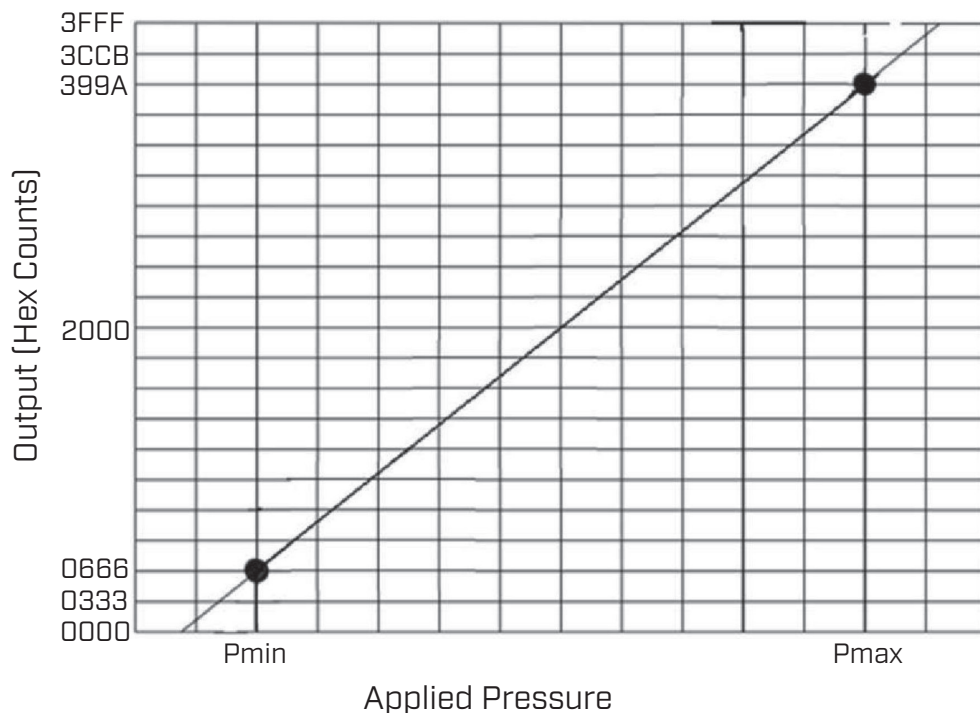

| Output[%] | Decimal[D] | Hexadecimal[H] |
|-----------|------------|----------------|
| 0 | 0 | 0x0000 |
| 5 | 819 | 0x0333 |
| 10 | 1638 | 0x0666 |
| 50 | 8192 | 0x2000 |
| 90 | 14746 | 0x399A |
| 95 | 15563 | 0x3CCB |
| 100 | 16383 | 0x3FFF |

USAGE CONSIDERATIONS

1. Do not touch the diaphragm with hard objects, which may cause damage to the diaphragm.
2. Strictly follow the wiring method, otherwise it may cause product damage or other potential faults.
3. Misuse of the product may cause danger or personal injury.
4. Pressure range can be selected higher or lower than actual conditions, but should be within $\pm 30\%FS$.
5. Pressure reference consists of gauge pressure, absolute pressure, and sealed gauge pressure.
 - a. Gauge pressure is based on the current atmospheric pressure. Generally, it refers to the measurement of pressure which is greater than the current atmospheric pressure. Negative pressure is a special case of gauge pressure. It refers that there is such working condition that the pressure of work site is lower than the current atmospheric pressure.
 - b. Absolute pressure is based on vacuum.
 - c. Sealed gauge pressure uses absolute pressure die for gauge pressure product based on the atmospheric pressure of production site.
6. Confirm the maximum overload of the applied system, which should be less than the overload protection limit of the sensor, otherwise it will affect the product life or even damage the product.
7. The material and process for manufacturing negative pressure sensors are different from those of positive pressure sensors. So, gauge pressure sensors cannot be used as substitute of negative pressure sensors.

REVISION HISTORY

| rev. | description | date |
|------|--------------------------------|------------|
| 1.0 | initial release | 12/14/2021 |
| 1.01 | updated drawing | 06/13/2022 |
| 1.02 | logo, datasheet style update | 08/05/2022 |
| 1.03 | added I ² C details | 12/12/2023 |

The revision history provided is for informational purposes only and is believed to be accurate.



CUI Devices offers a one (1) year limited warranty. Complete warranty information is listed on our website.

CUI Devices reserves the right to make changes to the product at any time without notice. Information provided by CUI Devices is believed to be accurate and reliable. However, no responsibility is assumed by CUI Devices for its use, nor for any infringements of patents or other rights of third parties which may result from its use.

CUI Devices products are not authorized or warranted for use as critical components in equipment that requires an extremely high level of reliability. A critical component is any component of a life support device or system whose failure to perform can be reasonably expected to cause the failure of the life support device or system, or to affect its safety or effectiveness.

cuidevices.com