

APPROVAL SHEET

WLSN105D Series Unshielded SMD Power Inductors



*Contents in this sheet are subject to change without prior notice.

Features

1. Unshielded power inductor.
2. Wide inductance range.

Applications

1. Inductor in DC/DC converter.
2. Use in STB、PDA、Notebook.

Shape and Dimension

Unit: mm

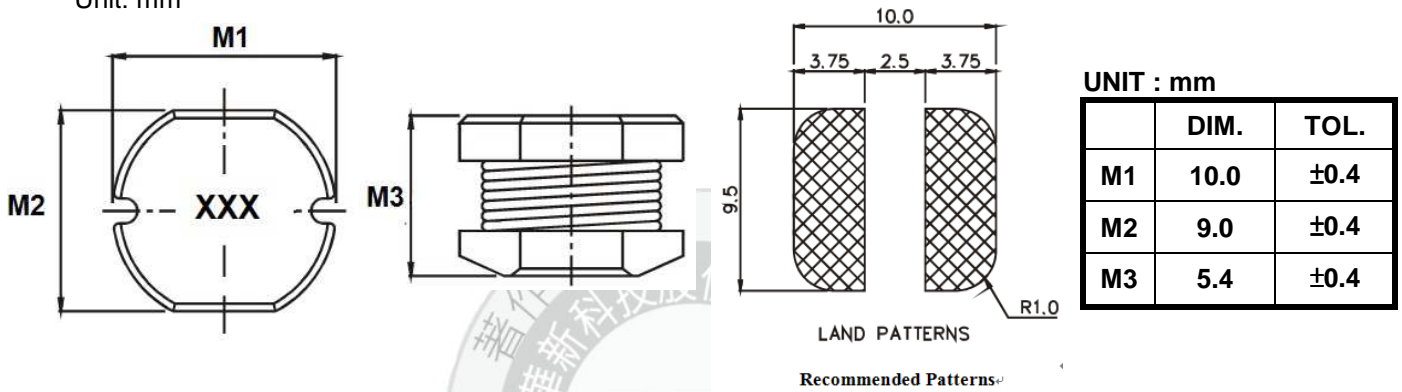

Ordering Information

WL	SN	105D	Z0	M	1R0	L	B
Product Code WL: Inductor	Series Unshielded SMD Power Inductors	Dimensions 10.0 * 9.0 * 5 mm	Series extension Z0:STD	Tolerance K: ± 10% M: ± 20%	Value 100 = 10.0uH 101 = 100uH	Packing Code P=13" Reeled (Embossed tape)	B:STD

Electrical Characteristics

WLSN105D Series	Marking	Inductance (uH)	Inductance Tolerance	Test Freq (KHz)	DCR MAX. (Ω)	Rated Current (A)
WLSN105DZ0□100LB	100	10	K, M	100	0.06	2.60
WLSN105DZ0□120LB	120	12	K, M	100	0.07	2.45
WLSN105DZ0□150LB	150	15	K, M	100	0.08	2.27
WLSN105DZ0□180LB	180	18	K, M	100	0.09	2.15
WLSN105DZ0□220LB	220	22	K, M	100	0.10	1.95
WLSN105DZ0□270LB	270	27	K, M	100	0.11	1.76
WLSN105DZ0□330LB	330	33	K, M	100	0.12	1.50
WLSN105DZ0□390LB	390	39	K, M	100	0.14	1.37
WLSN105DZ0□470LB	470	47	K, M	100	0.17	1.28
WLSN105DZ0□560LB	560	56	K, M	100	0.19	1.17
WLSN105DZ0□680LB	680	68	K, M	100	0.22	1.11
WLSN105DZ0□820LB	820	820	K, M	100	0.25	1.00
WLSN105DZ0□101LB	101	100	K, M	10	0.35	0.97
WLSN105DZ0□121LB	121	120	K, M	10	0.40	0.89
WLSN105DZ0□151LB	151	150	K, M	10	0.47	0.78
WLSN105DZ0□181LB	181	180	K, M	10	0.63	0.72
WLSN105DZ0□221LB	221	220	K, M	10	0.73	0.66
WLSN105DZ0□271LB	271	270	K, M	10	0.97	0.57
WLSN105DZ0□331LB	331	330	K, M	10	1.15	0.52
WLSN105DZ0□391LB	391	390	K, M	10	1.30	0.48
WLSN105DZ0□471LB	471	470	K, M	10	1.48	0.42
WLSN105DZ0□561LB	561	560	K, M	10	1.90	0.33
WLSN105DZ0□681LB	681	680	K, M	10	2.25	0.28
WLSN105DZ0□821LB	821	820	K, M	10	2.55	0.24

- a. Tolerance : M : ±20%, K : ±10%
 b. Operating Temp : -25°C to +105°C.
 c. Inductance measured using the HP4284A LCR meter, CHROMA3302/1320/16502.
 d. DCR measured using the 502BC milli-ohm meter.
 e. Inductance drops no more than 10 % of initial value at Isat , temperature rises $\Delta t < 40^{\circ}\text{C}$ at rated current.
 f. Storage Temperature Range:-40°C to +85°C

※MSL : LEVEL 1

ELECTRICAL CURVE

WLSN105DZ0□100LB

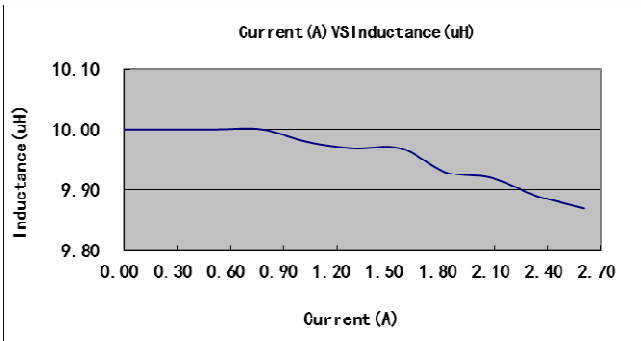

WLSN105DZ0□270LB

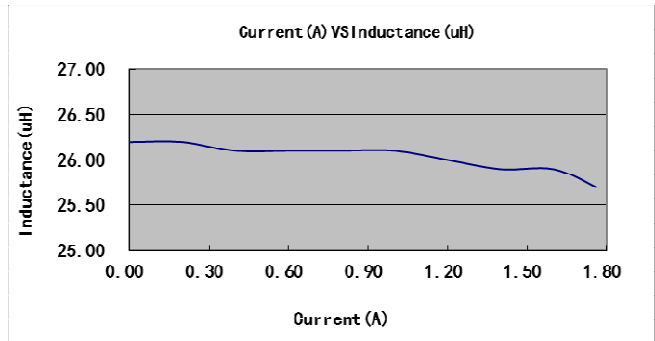

WLSN105DZ0□470LB

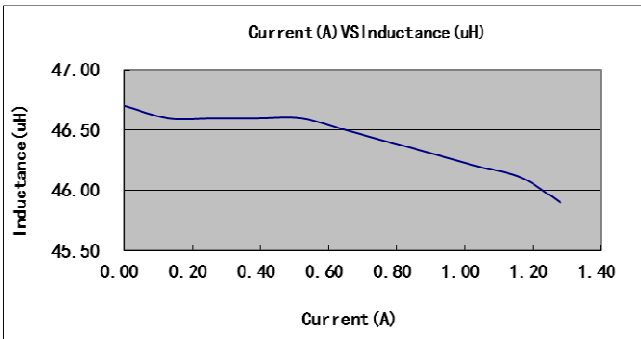

WLSN105DZ0□680LB

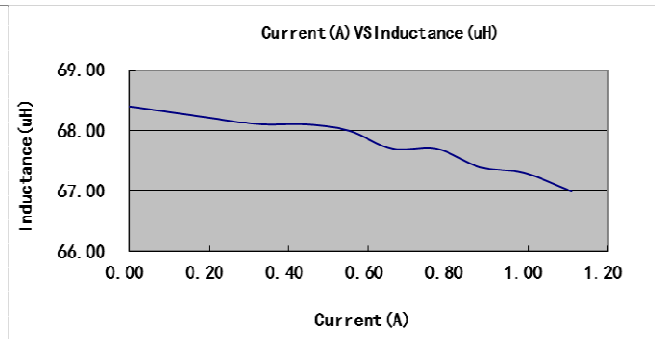

WLSN105DZ0□820LB

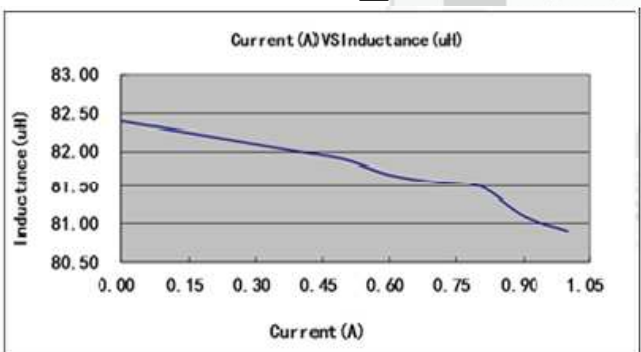

WLSN105DZ0□101LB

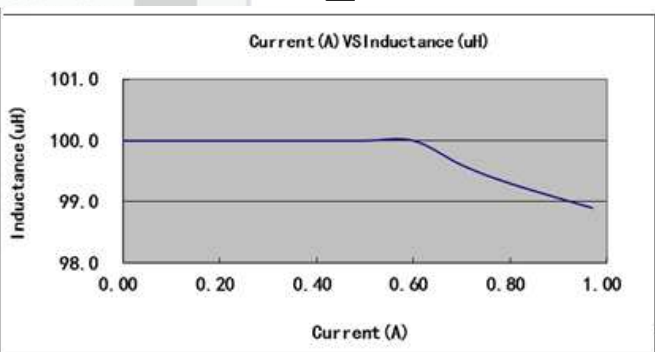

WLSN105DZ0□221LB

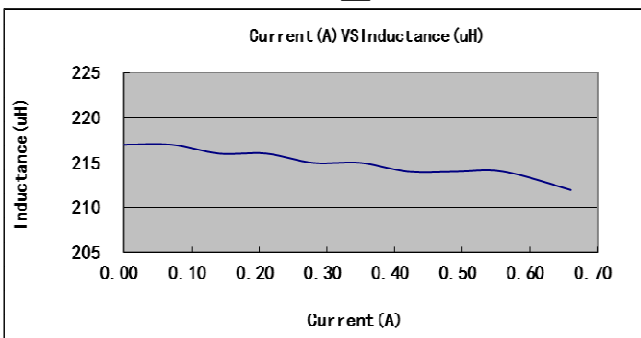

WLSN105DZ0□271LB

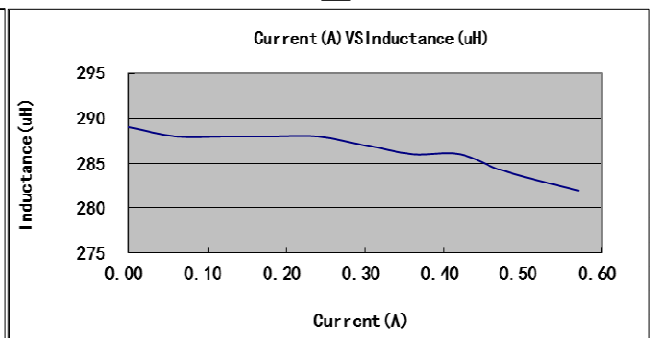

ELECTRICAL CURVE

WLSN105DZ0□681LB

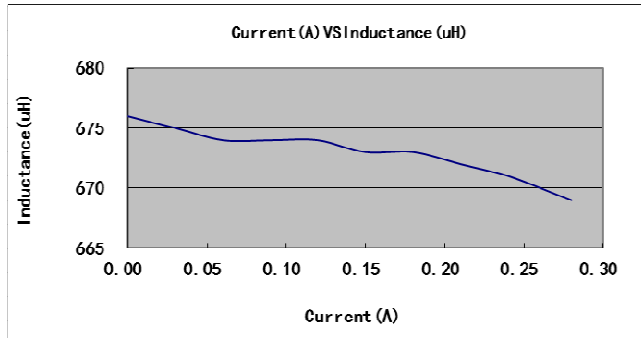

WLSN105DZ0□821LB

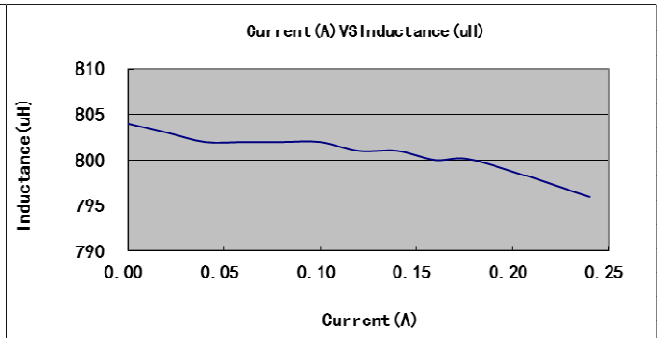

TYPICAL RoHS REFLOW PROFILE

Typical RoHS Reflow Profile

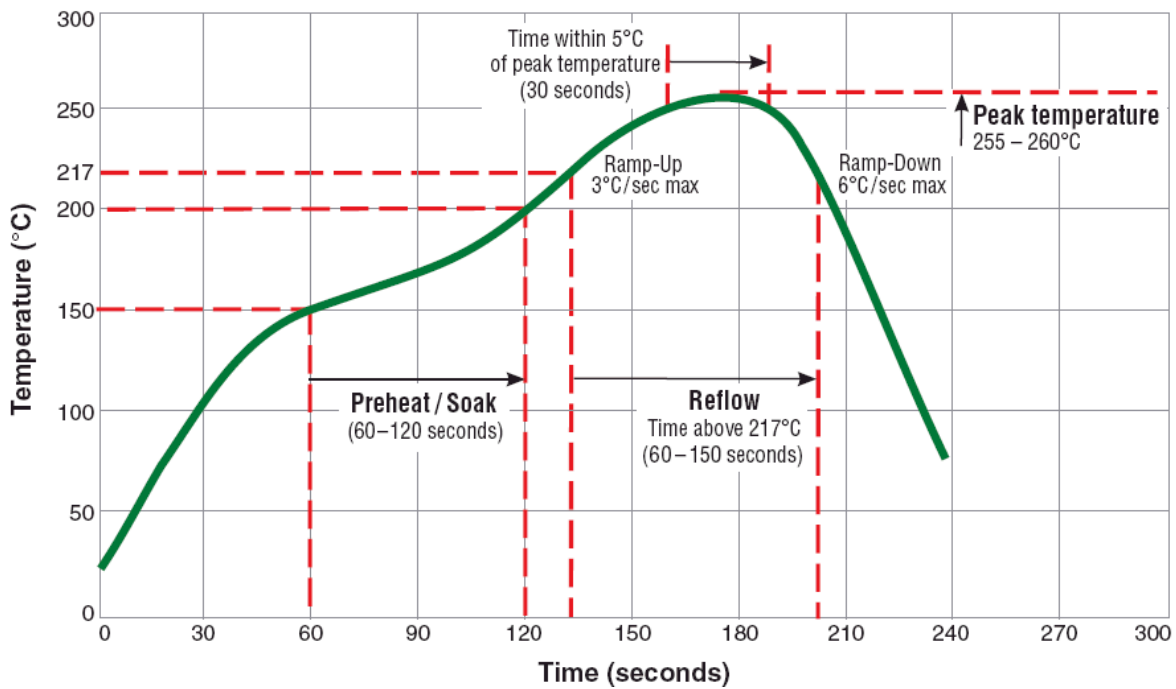

RELIABILITY PERFORMANCE

Reliability Experiment For Electrical

Test Item	Test Condition	Standard Source
Humidity Test	+40°C ± 2°C, humidity of 90% ± 5% (total 96 hours).	MIL-STD-202G Method 103B Test Condition B
High Temperature Test	1. Temperature: +125°C ± 2°C 2. Test time: 48 ± 2hrs	IEC 68-2 Test Condition B
Low Temperature Test	1. Temperature: -40°C ± 2°C 2. Test time: 48 ± 2hrs	IEC 68-2 Test Condition A
Thermal Shock	+125°C ± 5°C (30 minutes) ~ -40 ± 5°C (30 minutes), temperature switch time: 5 minutes (total 50 cycles).	MIL-STD-202G Method 107G Test Condition B-2
Life Test	+70°C ± 5°C (250Hours)	MIL-STD-202G Method 108A Test Condition B

Reliability Experiment For Physical

Test Item	Test Condition	Standard Source
Vibration Test	10-55-10HZ, amplitude: 1.5mm, direction: X, Y, Z axes, each axis 2 hours (total 6 hours).	MIL-STD-202G Method 201A
Solder Heat Resistance Test	IR/convection reflow: Peak Temp 250 ± 5°C for 5Sec in air, Through 2 Cycle. Temperature Ramp: +1~4°C/sec; Above 183°C, must keep 90 s - 120 s	MIL-STD-202G Method 210F Test Condition (Reflow)
Solder Ability Test	Soak in 245 °C solder pot of 3Sec, PAD must have 95% above coverage.	J-STD-003B

Tape & Reel Packaging Dimensions:

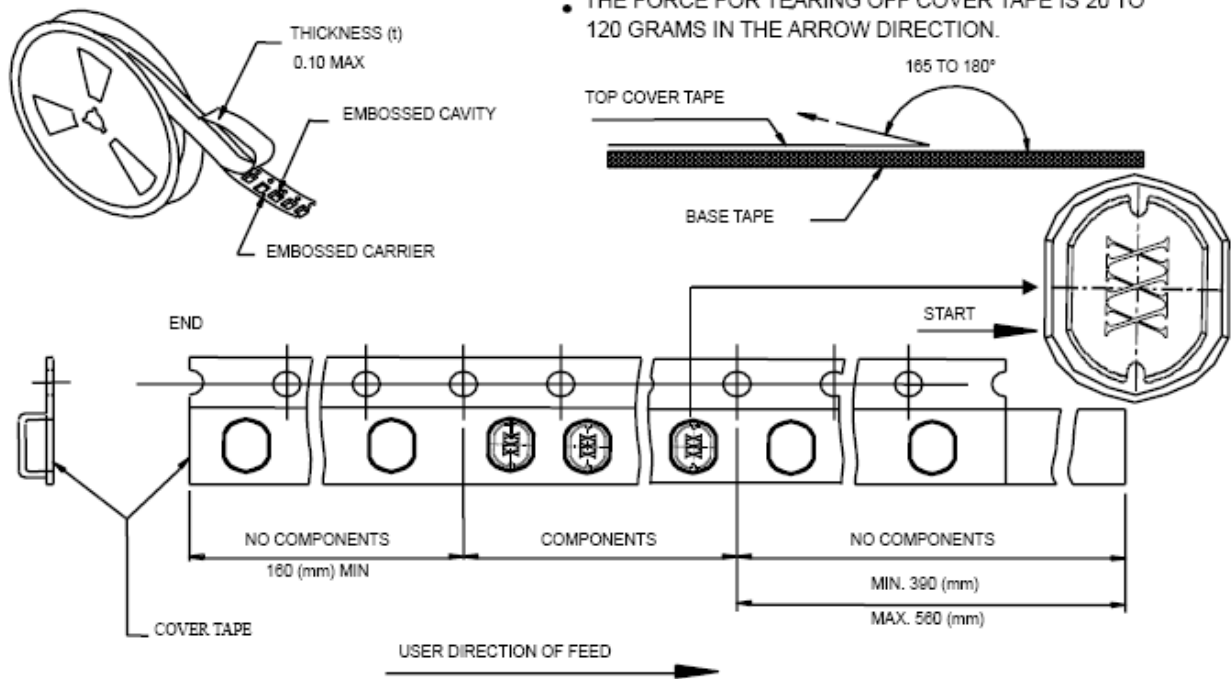

• THE FORCE FOR TEARING OFF COVER TAPE IS 20 TO 120 GRAMS IN THE ARROW DIRECTION.

■ CARRIER TAPE REELS (mm)

MATERIAL: PLASTIC

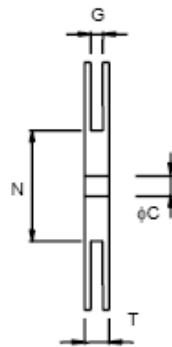
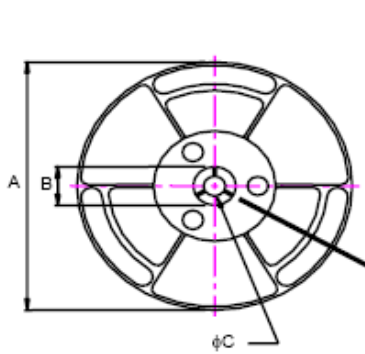

■ DIMENSIONS OF CARRIER TAPE (mm)

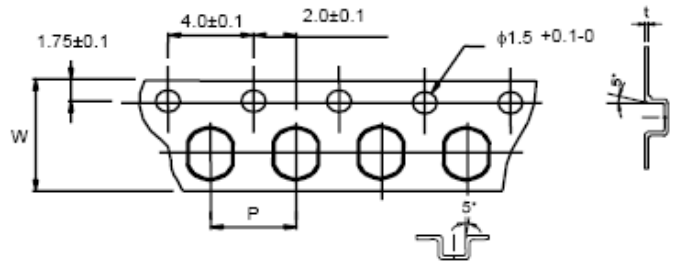

UNIT : mm

	A	B	C	G	N	P	T	W	t
DIM.	360	21	13	24.4	100	16	30.4	24	0.3
TOL.	MAX.	±0.8	±0.5	±2.0	MIN.	±0.1	MAX.	±0.3	±0.05

Quantity per reel : 0.7K pcs