

APPROVAL SHEET



WQQC Series
SMD Square Air Wound Coil Inductors
AEC-Q200

*Contents in this sheet are subject to change without prior notice.

FEATURES

1. Excellence Q and SRF characteristics for RF application.
2. Wide range inductance and various tolerance options.
3. RoHS compliant
4. AEC-Q200

APPLICATIONS

1. Communication system front-end circuit: GSM/3G/LTE, Wi-Fi, GPS.
2. Cabel/Terrestrial/BS Tuner, Bluetooth, Wireless Audio, Remote control.
3. M2M: ZigBee, Proprietary wilreless.
4. EMI solusion in high frequency circuits.
5. Automotive

Shape and Dimension

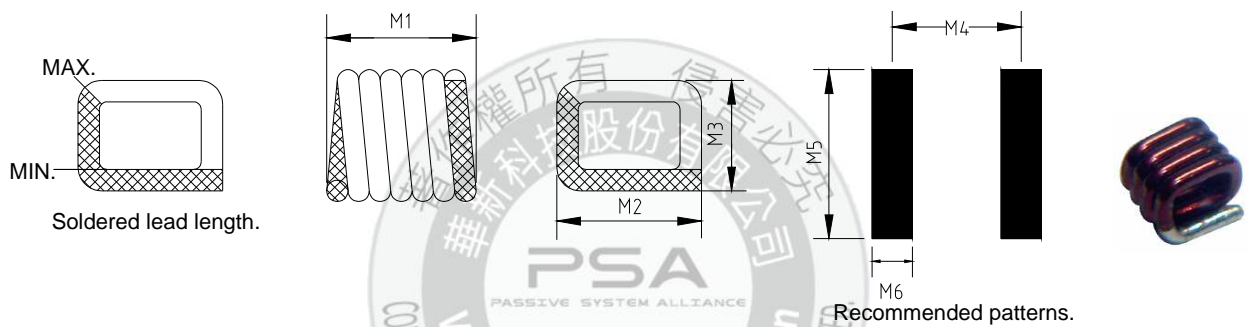

Unit: mm

WQQC0806 Series	M1	M2	M3	M4	M5	M6
WQQC0806Z0□5N5PB	1.346±0.102	1.829±0.254	1.397±0.102	0.962	2.6	0.51
WQQC0806Z0□6N0PB	1.295±0.102	1.829±0.254	1.397±0.102	1.020	2.6	0.51
WQQC0806Z0□8N9PB	1.626±0.152	1.829±0.254	1.397±0.102	1.320	2.6	0.51
WQQC0806Z0□12NPB	1.930±0.152	1.829±0.254	1.397±0.102	1.630	2.6	0.51
WQQC0806Z0□16NPB	2.286±0.152	1.829±0.254	1.397±0.102	1.960	2.6	0.51
WQQC0806Z0□19NPB	2.591±0.152	1.829±0.254	1.397±0.102	2.290	2.6	0.51
WQQC0807 Series	M1	M2	M3	M4	M5	M6
WQQC0807Z0□6N9PB	1.295±0.102	1.829±0.254	1.524±0.254	1.02	2.6	0.51
WQQC0807Z0□10NPB	1.626±0.102	1.829±0.254	1.524±0.254	1.32	2.6	0.51
WQQC0807Z0□11NPB	1.549±0.152	1.829±0.254	1.524±0.254	1.24	2.6	0.51
WQQC0807Z0□14NPB	1.930±0.152	1.829±0.254	1.524±0.254	1.63	2.6	0.51
WQQC0807Z0□17NPB	2.286±0.152	1.829±0.254	1.524±0.254	1.96	2.6	0.51
WQQC0807Z0□22NPB	2.591±0.152	1.829±0.254	1.524±0.254	2.29	2.6	0.51

WQQC0908 Series	M1	M2	M3	M4	M5	M6
WQQC0908Z0□8N1PB	1.473±0.152	2.134±0.152	1.829±0.152	1.12	2.8	0.64
WQQC0908Z0□12NPB	1.854±0.152	2.134±0.152	1.829±0.152	1.45	2.8	0.64
WQQC0908Z0□15NPB	1.549±0.152	2.134±0.152	1.829±0.152	1.24	2.8	0.64
WQQC0908Z0□17NPB	2.210±0.152	2.134±0.152	1.829±0.152	1.83	2.8	0.64
WQQC0908Z0□22NPB	2.565±0.152	2.134±0.152	1.829±0.152	2.18	2.8	0.64
WQQC0908Z0□23NPB	2.235±0.152	2.134±0.152	1.829±0.152	1.90	2.8	0.64
WQQC0908Z0□25NPB	2.972±0.152	2.134±0.152	1.829±0.152	2.57	2.8	0.64
WQQC0908Z0□27NPB	2.972±0.152	2.134±0.152	1.829±0.152	2.57	2.8	0.64

Ordering Information

WQ	QC	0806	Z0	J	5N5	P	B
Product Code WQ: Inductor AEC-Q200	Series Square air wound coil inductor.	Dimensions 0806 0807 0908	Series extension Z0:STD	Tolerance J: ± 5%	Value 5N5 =5.5nH 17N=17nH	Packing Code P=7" Reeled (Embossed Tape)	B B:STD

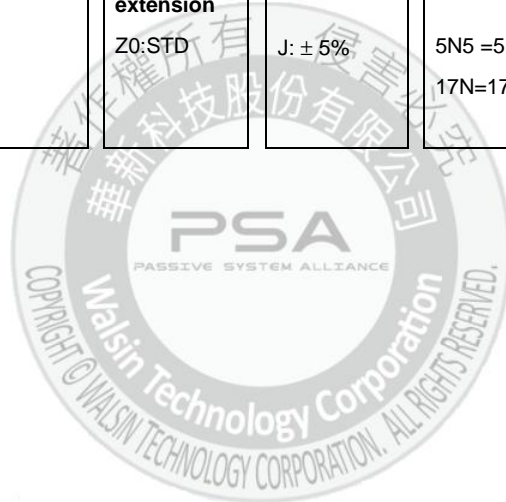

Electrical Characteristics

WQQC0806 Series	Turns	Tolerance	L (nH)	Q (min)	Test Freq (MHz)	DCR (mΩ)Max	SRF (GHz)Typ	Rated Current (A) Max
WQQC0806Z0□5N5PB	3	J	5.5	60	400	3.4	4.9	2.9
WQQC0806Z0□6N0PB	3	J	6.0	64	400	6.0	5.2	2.9
WQQC0806Z0□8N9PB	4	J	8.9	90	400	7.0	4.3	2.9
WQQC0806Z0□12NPB	5	J	12.3	90	400	8.0	4.8	2.9
WQQC0806Z0□16NPB	6	J	15.7	90	400	9.0	4.4	2.9
WQQC0806Z0□19NPB	7	J	19.4	90	400	10.0	4.0	2.9
WQQC0807 Series	Turns	Tolerance	L (nH)	Q (min)	Test Freq (MHz)	DCR (mΩ)Max	SRF (GHz)Typ	Rated Current (A) Max
WQQC0807Z0□6N9PB	3	J	6.9	100	400	6.0	4.6	2.7
WQQC0807Z0□10NPB	4	J	10.2	100	400	7.0	4.0	2.7
WQQC0807Z0□11NPB	4	J	11.2	90	400	6.3	3.6	2.7
WQQC0807Z0□14NPB	5	J	13.7	100	400	8.0	4.3	2.7
WQQC0807Z0□17NPB	6	J	17.0	100	400	9.0	4.0	2.7
WQQC0807Z0□22NPB	7	J	22.0	100	400	10.0	3.5	2.7
WQQC0908 Series	Turns	Tolerance	L (nH)	Q (min)	Test Freq (MHz)	DCR (mΩ)Max	SRF (GHz)Typ	Rated Current (A) Max
WQQC0908Z0□8N1PB	3	J	8.1	130	400	6.0	5.2	4.4
WQQC0908Z0□12NPB	4	J	12.1	130	400	7.0	4.3	4.4
WQQC0908Z0□15NPB	4	J	14.7	90	400	7.2	3.0	4.4
WQQC0908Z0□17NPB	5	J	16.6	130	400	8.0	3.4	4.4
WQQC0908Z0□22NPB	6	J	21.5	130	400	9.0	3.7	4.4
WQQC0908Z0□23NPB	6	J	23.0	130	400	10.0	2.6	4.4
WQQC0908Z0□25NPB	7	J	25.0	130	400	10.0	2.5	4.4
WQQC0908Z0□27NPB	7	J	27.3	130	400	10.0	3.2	4.4

1. Tolerance : J:±5%,
2. Inductance & Q measured on the HP4291B. With HP16193A test fixture.
3. SRF measured using the HP8753E
4. Operating temperature range: -40°C to +125°C.
5. Storage temperature Component:-40°C to +145°C, Packaging : -40°C. TO +80°C
6. Electrical specifications at 25°C.
7. MSL : LEVEL 1

Characteristic Curve

WQQC0806

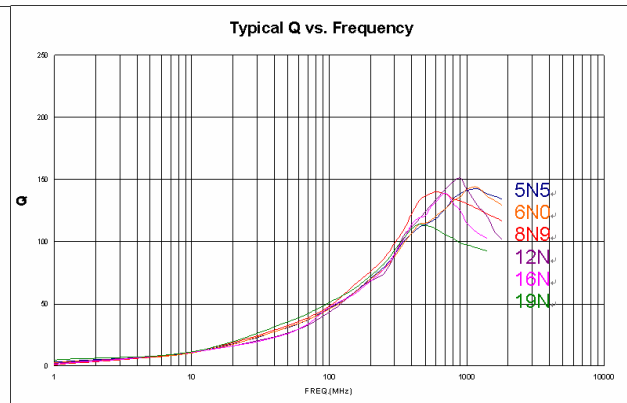
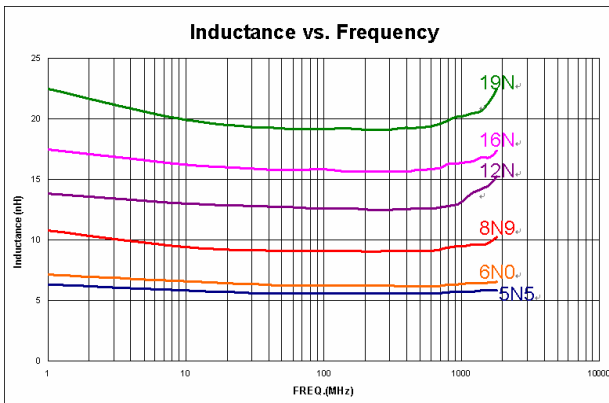

WQQC0807

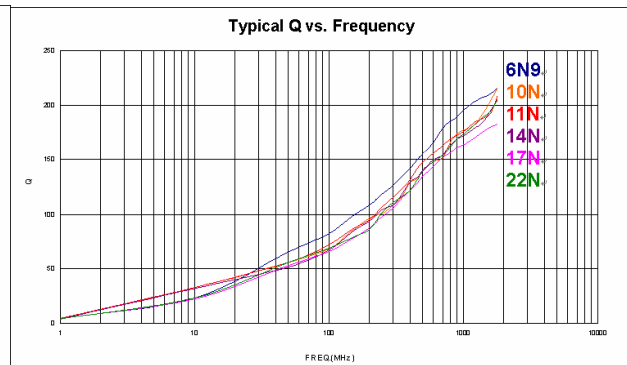
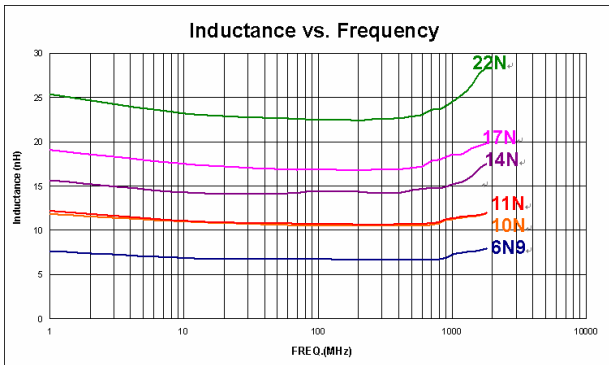

WQQC0908

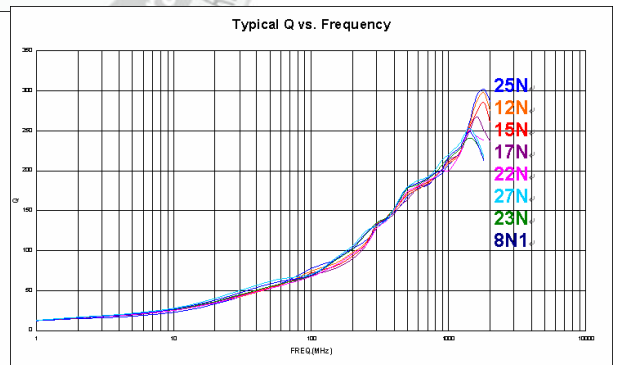
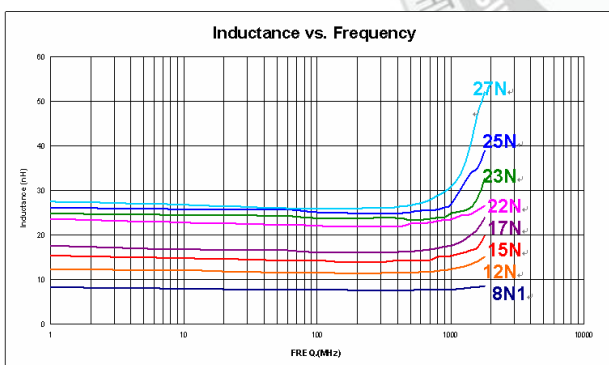

RELIABILITY PERFORMANCE

Test Item	Test Condition	Standard Source
High Temperature Exposure (Storage)	1000 hrs. at rated operating temperature (e.g. 125°C part can be stored for 1000 hrs. @ 125°C. Same applies for 105°C and 85°C. Unpowered. Measurement at 24±4 hours after test conclusion.	MIL-STD-202 Method 108
Temperature Cycling	1000 cycles (-40°C to +125°C). Note: If 85°C part or 105°C part the 1000 cycles will be at that temperature. Measurement at 24±4 hours after test conclusion. 30min maximum dwell time at each temperature extreme. 1 min. maximum transition time.	JESD22 Method JA-104
Biased Humidity	1000 hours 85°C/85%RH. Unpowered. Measurement at 24±4 hours after test conclusion.	MIL-STD-202 Method 103
Operational Life	1000 hrs. @ 105°C. If 85°C or 125°C part will be tested at that temperature. Measurement at 24±4 hours after test conclusion.	MIL-PRF-27
Mechanical Shock	Method 213. Condition C, Peak Value: 100g's, Duration: 6ms, Waveform: Half-sine Velocity Change: 12.3ft/sec	MIL-STD-202 Method 213
Vibration	5g's for 20 minutes, 12 cycles each of 3 orientations. Note: Use 8"X5" PCB, .031" thick, 7 secure points on one long side and 2 secure points at corners of opposite sides. Parts mounted within 2" from any secure point. Test from 10-2000 Hz.	MIL-STD-202 Method 204
Resistance to Soldering Heat	Condition B No pre-heat of samples. Note: Single Wave Solder - Procedure 2 for SMD and Procedure 1 for Leaded with solder within 1.5mm of device body.	MIL-STD-202 Method 210
ESD	Passive Component Human Body Model (HBM) Electrostatic Discharge (ESD) Test. Only direct contact discharge, record the voltage value what the sample can pass.	AEC-Q200-002 Or ISO/DIS10605
Solderability	For both Leaded & SMD. Electrical Test not required. Magnification 50X. Conditions: Leaded: Method A @ 235°C, category 3. SMD: a) Method B, 4 hrs @ 155°C dry heat @ 235°C b) Method B @ 215°C category 3. c) Method D category 3 @ 260°C.	J-STD-002
Flammability	V-0 or V-1 Acceptable	UL-94
Board Flex	60 sec minimum holding time.	AEC-Q200-005
Terminal Strength (SMD)	Force of 1.8kg for 60 seconds.	AEC-Q200-006

TYPICAL RoHS REFLOW PROFILE

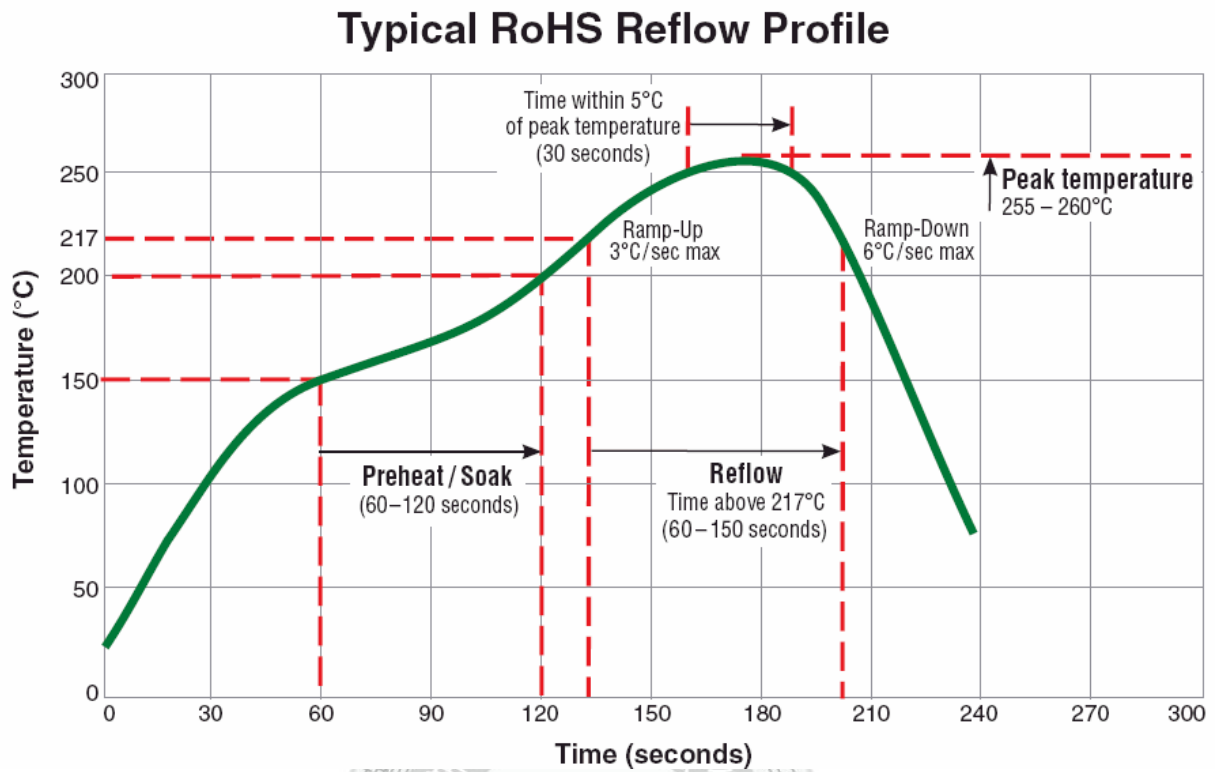

Packaging Specification

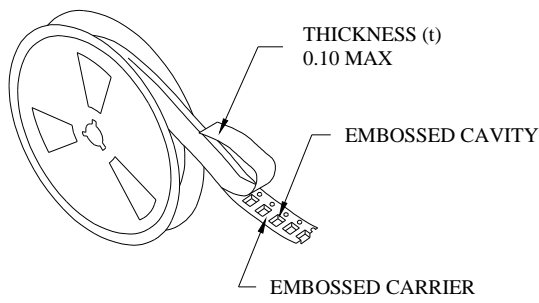

- THE FORCE FOR TEARING OFF COVER TAPE IS 10 TO 130 GRAMS IN THE ARROW DIRECTION.

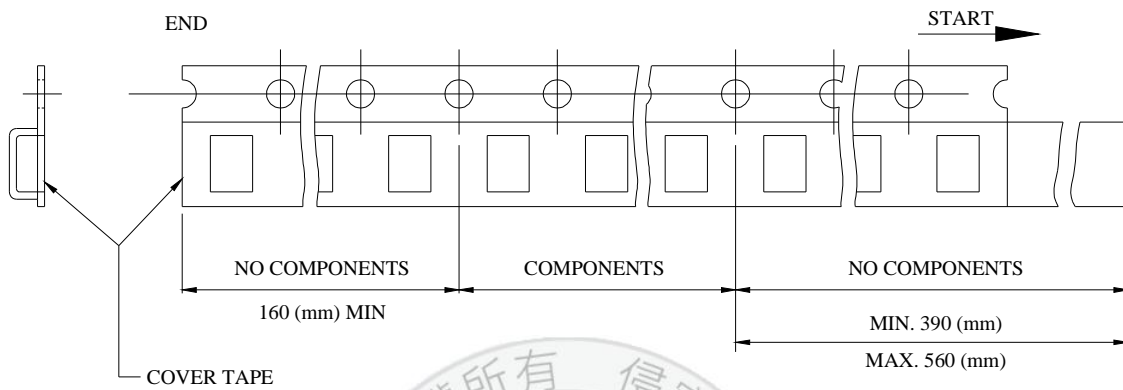
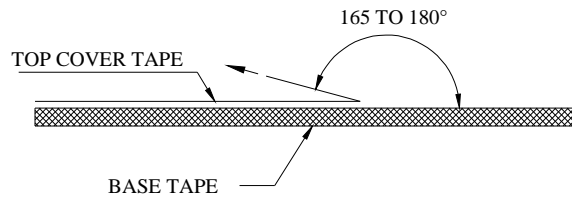

■ CARRIER TAPE REELS (mm)

MATERIAL: PLASTIC

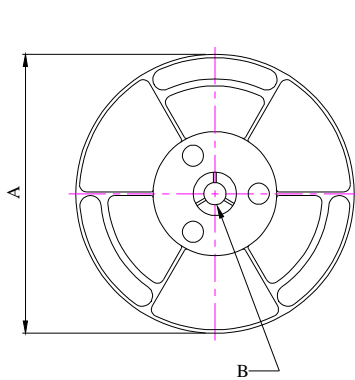

(Unit : mm)

■ DIMENSIONS OF CARRIER TAPE (mm)

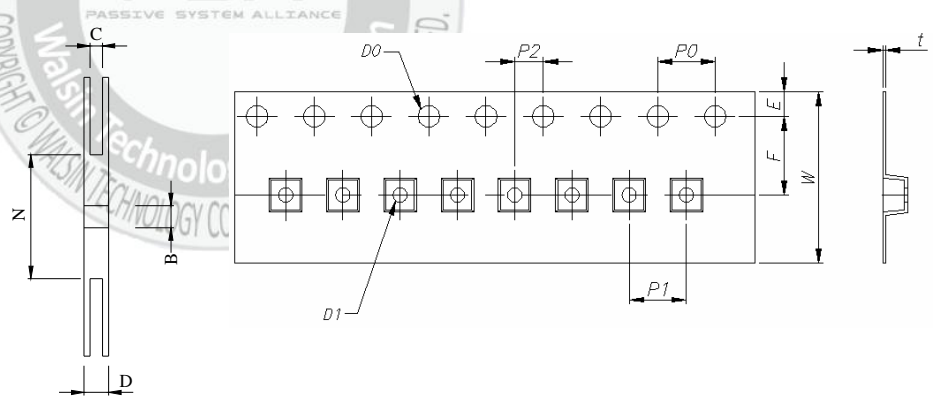

0806	A	B	C	D	N	W	E	F	P1	P2	P0	D0	D1	t
DIM.	178	13.0	12.4	16.8	50	12.0	1.75	5.50	4.00	2.0	4.0	1.5	1.0	0.23
TOL.	±2.0	+0.5 -0.2	+2.0 -0	MAX.	MIN.	±0.2	±0.1	±0.1	±0.10	±0.1	±0.1	+0.1/-0	±0.1	±0.05

0807	A	B	C	D	N	W	E	F	P1	P2	P0	D0	D1	t
DIM.	178	13.0	12.4	16.8	50	12.0	1.75	5.50	4.00	2.0	4.0	1.5	1.0	0.23
TOL.	±2.0	+0.5 -0.2	+2.0 -0	MAX.	MIN.	±0.2	±0.1	±0.1	±0.10	±0.1	±0.1	+0.1/-0	±0.1	±0.05

0908	A	B	C	D	N	W	E	F	P1	P2	P0	D0	D1	t
DIM.	178	13.0	12.4	16.8	50	12.0	1.75	5.50	4.00	2.0	4.0	1.5	1.0	0.25
TOL.	±2.0	+0.5 -0.2	+2.0 -0	MAX.	MIN.	±0.2	±0.1	±0.1	±0.10	±0.1	±0.1	+0.1/-0	±0.1	±0.05

Quantity per reel : 2K pcs

