

# MILITARY i860™ XR 32/64-BIT MICROPROCESSOR

- **Parallel Architecture that Supports Up to Three Operations per Clock**
  - One Integer or Control Instruction per Clock
  - Up to Two Floating-Point Results per Clock
- **High Performance Design**
  - 80 Peak Single Precision MFLOPs
  - 60 Peak Double Precision MFLOPs
  - 64-Bit External Data Bus
  - 64-Bit Internal Instruction Cache Bus
  - 128-Bit Internal Data Cache Bus
- **High Level of Integration on One Chip**
  - 32-Bit Integer and Control Unit
  - 32/64-Bit Pipelined Floating-Point Adder and Multiplier Units
  - 64-Bit 3-D Graphics Unit
  - Paging Unit with Translation Lookaside Buffer (TLB)
  - 4 Kbyte Instruction Cache
  - 8 Kbyte Data Cache
- **Compatible with Industry Standards**
  - ANSI/IEEE Standard 754-1985 for Binary Floating-Point Arithmetic
  - i386™/i486™ Microprocessor Data Formats and Page Table Entries
- **Easy to Use**
  - On-Chip Debug Register
  - Assembler, Linker, Simulator, Debugger, C, FORTRAN and Ada Compilers, FORTRAN Vectorizer, Scalar and Vector Math Libraries for both VMS\* and UNIX\* Environments
- **Military Temperature Range:**
  - 55°C to +125°C (T<sub>C</sub>)
- **Available in a 168-pin Ceramic Pin Grid Array Package** (See Package/Module/PC Card Outlines and Dimensions, Order #231369)
- **Available in 196-Lead Ceramic Quad Flatpack** (See Package/Module/PC Card Outlines and Dimensions, Order #231369)

The Intel i860™ XR Microprocessor delivers supercomputing performance in a single VLSI component. The 32/64-bit design of the i860 XR Microprocessor balances integer, floating point and graphics performance for applications such as target tracking, acoustic imaging, terrain data mapping and image processing. Its parallel architecture achieves high throughput with RISC design techniques, pipelined processing units, wide data paths, large on-chip caches, million-transistor design, and fast one-micron CHMOS IV silicon technology.

**NOTE:**

References to devices within this document refer to the Military versions of those devices.

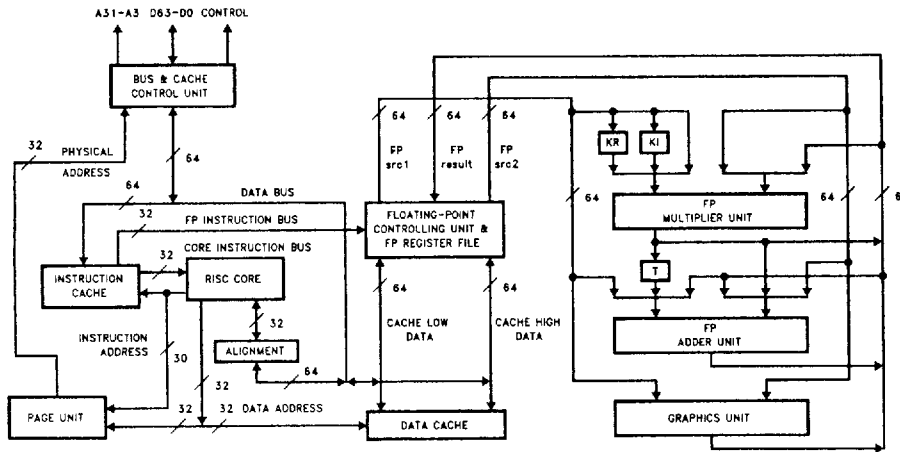

Figure 0.1 Block Diagram

271121-1



Intel, intel, i386, i486 and i860 are trademarks of Intel Corporation  
 \*UNIX is a registered trademark of AT&T. \*VMS is a trademark of Digital Equipment Corporation.

October 1992  
 Order Number: 271121-005

# Military i860™ XR 32/64-Bit Microprocessor

## CONTENTS

|  | PAGE |
|--|------|
| <b>1.0 FUNCTIONAL DESCRIPTION</b> .....        | 9-7  |
| <b>2.0 PROGRAMMING INTERFACE</b> .....         | 9-7  |
| 2.1 Data Types .....                           | 9-8  |
| 2.1.1 Integer .....                            | 9-8  |
| 2.1.2 Ordinal .....                            | 9-8  |
| 2.1.3 Single- and Double-Precision Real .....  | 9-8  |
| 2.1.4 Pixel .....                              | 9-9  |
| 2.2 Register Set .....                         | 9-9  |
| 2.2.1 Integer Register File .....              | 9-10 |
| 2.2.2 Floating-Point Register File .....       | 9-10 |
| 2.2.3 Processor Status Register .....          | 9-10 |
| 2.2.4 Extended Processor Status Register ..... | 9-13 |
| 2.2.5 Data Breakpoint Register .....           | 9-14 |
| 2.2.6 Directory Base Register .....            | 9-14 |
| 2.2.7 Fault Instruction Register .....         | 9-15 |
| 2.2.8 Floating-Point Status Register .....     | 9-15 |
| 2.2.9 KR, KI, T and MERGE Registers .....      | 9-16 |
| 2.3 Addressing .....                           | 9-17 |
| 2.4 Virtual Addressing .....                   | 9-17 |
| 2.4.1 Page Frame .....                         | 9-19 |
| 2.4.2 Virtual Address .....                    | 9-19 |
| 2.4.3 Page Tables .....                        | 9-19 |
| 2.4.4 Table Entries .....                      | 9-20 |
| 2.4.5 Address Translation Algorithm .....      | 9-22 |
| 2.4.6 Address Translation Faults .....         | 9-23 |
| 2.4.7 Page Translation Cache .....             | 9-23 |
| 2.5 Caching and Cache Flushing .....           | 9-23 |
| 2.6 Instruction Set .....                      | 9-24 |
| 2.6.1 Pipelined and Scalar Operations .....    | 9-24 |
| 2.6.2 Dual-Instruction Mode .....              | 9-27 |
| 2.6.3 Dual-Operation Instructions .....        | 9-28 |

**CONTENTS**

PAGE

**2.0 PROGRAMMING INTERFACE (Continued)**

2.7 Addressing Modes ..... 9-28

2.8 Traps and Interrupts ..... 9-29

    2.8.1 Trap Handler Invocation ..... 9-29

    2.8.2 Instruction Fault ..... 9-30

    2.8.3 Floating-Point Fault ..... 9-30

    2.8.4 Instruction Access Fault ..... 9-31

    2.8.5 Data Access Fault ..... 9-31

    2.8.6 Interrupt Trap ..... 9-32

    2.8.7 Reset Trap ..... 9-32

2.9 Debugging ..... 9-32

**3.0 HARDWARE INTERFACE** ..... 9-32

3.1 Signal Description ..... 9-32

    3.1.1 Clock (CLK) ..... 9-33

    3.1.2 System Reset (RESET) ..... 9-33

    3.1.3 Bus Hold (HOLD) and Bus Hold Acknowledge (HLDA) ..... 9-33

    3.1.4 Bus Request (BREQ) ..... 9-33

    3.1.5 Interrupt/Code-Size (INT/CS8) ..... 9-33

    3.1.6 Address Pins (A31–A3) and Byte Enables ( $\overline{BE7}$ – $\overline{BE0}$ ) ..... 9-34

    3.1.7 Data Pins (D63–D0) ..... 9-35

    3.1.8 Bus Lock ( $\overline{LOCK}$ ) ..... 9-35

    3.1.9 Write/Read Bus Cycle (W/ $\overline{R}$ ) ..... 9-35

    3.1.10 Next Near ( $\overline{NENE}$ ) ..... 9-35

    3.1.11 Next Address Request ( $\overline{NA}$ ) ..... 9-35

    3.1.12 Transfer Acknowledge ( $\overline{READY}$ ) ..... 9-36

    3.1.13 Address Status ( $\overline{ADS}$ ) ..... 9-36

    3.1.14 Cache Enable ( $\overline{KEN}$ ) ..... 9-36

    3.1.15 Page Table Bit (PTB) ..... 9-36

    3.1.16 Boundary Scan Shift Input (SHI) ..... 9-36

    3.1.17 Boundary Scan Enable (BSCN) ..... 9-36

    3.1.18 Shift Scan Path (SCAN) ..... 9-36

    3.1.19 Configuration (CC1–CC0) ..... 9-36

    3.1.20 System Power ( $V_{CC}$ ) and Ground ( $V_{SS}$ ) ..... 9-36

3.2 Initialization ..... 9-37

3.3 Testability ..... 9-37

    3.3.1 Normal Mode ..... 9-38

    3.3.2 Shift Mode ..... 9-38



**PRELIMINARY**

9-3



**CONTENTS**

PAGE

**4.0 BUS OPERATION** ..... 9-38

    4.1 Pipelining ..... 9-39

    4.2 Bus State Machine ..... 9-39

    4.3 Bus Cycles ..... 9-41

        4.3.1 Nonpipelined Read Cycles ..... 9-41

        4.3.2 Nonpipelined Write Cycles ..... 9-42

        4.3.3 Pipelined Read and Write Cycles ..... 9-44

        4.3.4 Locked Cycles ..... 9-46

        4.3.5 HOLD and BREQ Arbitration Cycles ..... 9-46

    4.4 Bus States During RESET ..... 9-47

**5.0 MECHANICAL DATA** ..... 9-48

**6.0 ELECTRICAL DATA** ..... 9-55

    6.1 Absolute Maximum Ratings ..... 9-55

    6.2 Operating Conditions ..... 9-55

    6.3 DC Characteristics ..... 9-55

    6.4 AC Characteristics ..... 9-56

**7.0 INSTRUCTION SET** ..... 9-58

    7.1 Instruction Definitions in Alphabetical Order ..... 9-59

    7.2 Instruction Format and Encoding ..... 9-67

        7.2.1 REG-Format Instructions ..... 9-67

        7.2.2 CTRL-Format Instructions ..... 9-70

        7.2.3 Floating-Point Instructions ..... 9-71

    7.3 Instruction Timings ..... 9-73

    7.4 Instruction Characteristics ..... 9-76

PRELIMINARY |

**FIGURES**

- Figure 0.1 Block Diagram
- Figure 2.1 Real Number Formats
- Figure 2.2 Pixel Format Example
- Figure 2.3 Registers and Data Paths
- Figure 2.4 Processor Status Register (psr)
- Figure 2.5 Extended Processor Status Register (epsr)
- Figure 2.6 Directory Base Register (dirbase)
- Figure 2.7 Floating-Point Status Register (fsr)
- Figure 2.8 Little and Big Endian Accesses
- Figure 2.9 Format of a Virtual Address
- Figure 2.10 Address Translation
- Figure 2.11 Format of a Page-Table and Page-Directory Entry
- Figure 2.12 FP-Adder Pipelined Instruction Execution
- Figure 2.13 Dual-Instruction Mode Transitions
- Figure 2.14 Dual-Operation Data Paths
- Figure 3.1 Order of Boundary Scan Chain
- Figure 4.1 Bus State Machine
- Figure 4.2 Fastest Read Cycles
- Figure 4.3 Fastest Write Cycles
- Figure 4.4 Fastest Read/Write Cycles
- Figure 4.5 Pipelined Read Followed by Pipelined Write
- Figure 4.6 Pipelined Write Followed by Pipelined Read
- Figure 4.7 Pipelining Driven by  $\overline{NA}$
- Figure 4.8  $\overline{NA}$  Active with No Internal Bus Request
- Figure 4.9 Locked Cycles
- Figure 4.10 HOLD, HLDA and BREQ
- Figure 4.11 Reset Activities
- Figure 5.1 168-Pin Ceramic Pin Grid Array. Pin Configuration—View from Top Side
- Figure 5.2 168-Pin Ceramic Pin Grid Array. Pin Configuration—View from Pin Side
- Figure 5.3 196-Pin Ceramic Quad Flatpack. Pin Configuration—View from Lid Side
- Figure 6.1 CLK, Input and Output Timings
- Figure 7.1 REG-Format Variations
- Figure 7.2 Core Escape Instruction Format
- Figure 7.3 CTRL Instruction Format
- Figure 7.4 Floating-Point Instruction Encoding



**PRELIMINARY**

**TABLES**

|           |   |
|-----------|---|
| Table 2.1 | Pixel Formats   |
| Table 2.2 | Values of PS  |
| Table 2.3 | Values of RB  |
| Table 2.4 | Values of RC  |
| Table 2.5 | Values of RM  |
| Table 2.6 | Combining Directory and Page Protections                        |
| Table 2.7 | Instruction Set   |
| Table 2.8 | Types of Traps  |
| Table 2.9 | Register and Cache Values after Reset                           |
| Table 3.1 | Pin Summary   |
| Table 3.2 | Identifying Instruction Fetches                                 |
| Table 3.3 | Cacheability Based on $\overline{KEN}$ and CD or WT             |
| Table 3.4 | Output Pin Status During Reset                                  |
| Table 3.5 | Test Mode Selection   |
| Table 3.6 | Test Mode Latches   |
| Table 5.1 | 168-Pin Ceramic PGA Pin Assignment by Location                  |
| Table 5.2 | 168-Pin Ceramic PGA Pin Assignment by Function                  |
| Table 5.3 | 196-Pin Ceramic Quad Flatpack (CQFP) Pin Assignment by Location |
| Table 5.4 | 196-Pin Ceramic Quad Flatpack (CQFP) Pin Assignment by Function |
| Table 6.1 | DC Characteristics  |
| Table 6.2 | AC Characteristics  |
| Table 7.1 | Precision Specification   |
| Table 7.2 | FADDP MERGE Update  |
| Table 7.3 | Register Encoding   |
| Table 7.4 | REG-Format Opcodes  |
| Table 7.5 | Core Escape Opcodes   |
| Table 7.6 | CTRL-Format Opcodes   |
| Table 7.7 | Floating-Point Opcodes  |
| Table 7.8 | DPC Encoding  |
| Table 7.9 | Instruction Characteristics                                     |



### 1.0 FUNCTIONAL DESCRIPTION

As shown by the block diagram on the front page, the Military i860 XR microprocessor consists of 9 units:

1. RISC Based Core Execution Unit
2. Floating-Point Control Unit
3. Floating-Point Adder Unit
4. Floating-Point Multiplier Unit
5. Graphics Unit
6. Paging Unit
7. Instruction Cache
8. Data Cache
9. Bus and Cache Control Unit

The core execution unit controls overall operation of the Military i860 XR microprocessor. The core unit executes load, store, integer, bit, and control-transfer operations, and fetches instructions for the floating-point unit as well. A set of 32 x 32-bit general-purpose registers are provided for the manipulation of integer data. Load and store instructions move 8-, 16-, and 32-bit data to and from these registers. Its full set of integer, logical, and control-transfer instructions give the core unit the ability to execute complete systems software and applications programs. A trap mechanism provides rapid response to exceptions and external interrupts. Debugging is supported by the ability to trap on data or instruction reference.

The floating-point hardware is connected to a separate set of floating-point registers, which can be accessed as 16 x 64-bit registers, or 32 x 32-bit registers. Special load and store instructions can also access these same registers as 8 x 128-bit registers. All floating-point instructions use these registers as their source and destination operands.

The floating-point control unit controls both the floating-point adder and the floating-point multiplier, issuing instructions, handling all source and result exceptions, and updating status bits in the floating-point status register. The adder and multiplier can operate in parallel, producing up to two floating-point results per clock. The floating-point data types, floating-point instructions and exception handling all support the IEEE Standard for Binary Floating-Point Arithmetic (ANSI/IEEE Std 754-1985).

The floating-point adder performs addition, subtraction, comparison, and conversions on 64- and 32-bit floating-point values. An adder instruction executes in three clocks; however, in pipelined mode, a new result is generated every clock.

The floating-point multiplier performs floating-point and integer multiply and floating-point reciprocal operations on 64- and 32-bit floating-point values. A multiplier instruction executes in three to four clocks;

however, in pipelined mode, a new result can be generated every clock for single-precision and every other clock for double precision.

The graphics unit has special integer logic that supports three-dimensional drawing in a graphics frame buffer, with color intensity shading and hidden surface elimination via the Z-buffer algorithm. The graphics unit recognizes the pixel as an 8-, 16- or 32-bit data type. It can compute individual red, blue and green color intensity values within a pixel; but it does so with parallel operations that take advantage of the 64-bit internal word size and 64-bit external bus. The graphics features of the Military i860 XR microprocessor assume that the surface of a solid object is drawn with polygon patches whose shapes approximate the original object. The color intensities of the vertices of the polygon and their distances from the viewer are known, but the distances and intensities of the other points must be calculated by interpolation. The graphics instructions of the Military i860 XR microprocessor directly aid such interpolation.

The paging unit implements a protected, paged, virtual memory system via a 64-entry, four-way set-associative TLB (Translation Lookaside Buffer). The paging unit uses the TLB to perform the translation of logical address to physical address, and to check for access violations. The access protection scheme employs two levels of privilege: user and supervisor.

The instruction cache is a two-way set-associative memory of four Kbytes, with a 32-byte line size. It transfers up to 64 bits per clock (266 Mbyte/sec at 33 MHz).

The data cache is a two-way set-associative memory of eight Kbytes, with a 32-byte line size. It transfers up to 128 bits per clock (640 Mbyte/sec at 40 MHz). The Military i860 XR microprocessor uses writeback caching, i.e. memory writes update the cache (if applicable) without necessarily updating memory immediately; however, caching can be inhibited by software where necessary.

The bus and cache control unit performs data and instruction accesses for the core unit. It receives cycle requests and specifications from the core unit, performs the data-cache or instruction-cache miss processing, controls TLB translation, and provides the interface to the external bus. Its pipelined structure supports up to three outstanding bus cycles.



### 2.0 PROGRAMMING INTERFACE

The programmer-visible aspects of the architecture of the Military i860 XR microprocessor include data types, registers, instructions and traps.

**PRELIMINARY**

## 2.1 Data Types

The Military i860 XR microprocessor provides operations for integer and floating-point data. Integer operations are performed on 32-bit operands with some support also for 64-bit operands. Load and store instructions can reference 8-bit, 16-bit, 32-bit, 64-bit and 128-bit operands. Floating-point operations are performed on IEEE-standard 32- and 64-bit formats. Graphics oriented instructions operate on arrays of 8-, 16- or 32-bit pixels.

### 2.1.1 INTEGER

An integer is a 32-bit signed value in standard two's complement form. A 32-bit integer can represent a value in the range  $-2,147,483,648 (-2^{31})$  to  $2,147,483,647 (+2^{31} - 1)$ . Arithmetic operations on 8- and 16-bit integers can be performed by sign-extending the 8- or 16-bit values to 32 bits, then using the 32-bit operations.

There are also add and subtract instructions that operate on 64-bit long integers.

Load and store instructions may also reference (in addition to the 32- and 64-bit formats previously mentioned) 8- and 16-bit items in memory. When an 8- or 16-bit item is loaded into a register, it is converted to an integer by sign-extending the value to 32 bits. When an 8- or 16-bit item is stored from a register, the corresponding number of low-order bits of the register are used.

### 2.1.2 ORDINAL

Arithmetic operations are available for 32-bit ordinals. An ordinal is an unsigned integer. An ordinal can represent values in the range 0 to  $4,294,967,295 (+2^{32} - 1)$ .

Also, there are add and subtract instructions that operate on 64-bit ordinals.

### 2.1.3 SINGLE- AND DOUBLE-PRECISION REAL

Figure 2.1 shows the real number formats. A single-precision real (also called "single real") data type is a 32-bit binary floating-point number. Bit 31 is the sign bit; bits 30..23 are the exponent; and bits 22..0 are the fraction. In accordance with ANSI/IEEE standard 754, the value of a single-precision real is defined as follows:

1. If  $e = 0$  and  $f \neq 0$  or  $e = 255$  then generate a floating-point source-exception trap when encountered in a floating-point operation.
2. If  $0 < e < 255$ , then the value is  $(-1)^s \times 1.f \times 2^{e-127}$ .
3. If  $e = 0$  and  $f = 0$ , then the value is signed zero.

A double-precision real (also called "double real") data type is a 64-bit binary floating-point number. Bit 63 is the sign bit; bits 62..52 are the exponent; and bits 51..0 are the fraction. In accordance with ANSI/IEEE standard 754, the value of a double-precision real is defined as follows:

1. If  $e = 0$  and  $f \neq 0$  or  $e = 2047$ , then generate a floating-point source-exception trap when encountered in a floating-point operation.
2. If  $0 < e < 2047$ , then the value is  $(-1)^s \times 1.f \times 2^{e-1023}$ .

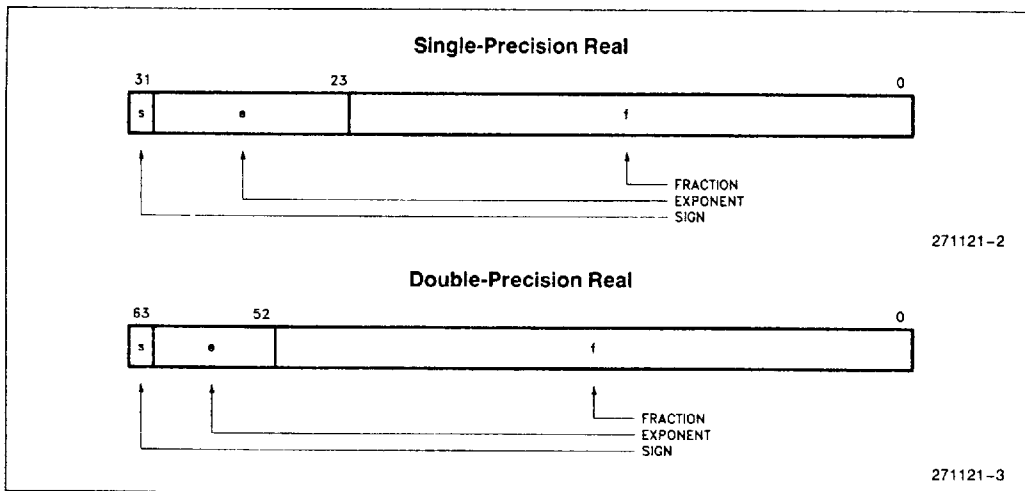

Figure 2.1 Real Number Formats



3. If  $e = 0$  and  $f = 0$ , then the value is signed zero.

The special values infinity, NaN ("Not a Number"), indefinite, and denormal generate a trap when encountered. The trap handler implements IEEE-standard results.

A double-precision real value occupies an even/odd pair of floating-point registers. Bits 31..0 are stored in the even-numbered floating-point register; bits 63..32 are stored in the next higher odd-numbered floating-point register.

### 2.1.4 PIXEL

A pixel may be 8, 16, or 32 bits long depending on color and intensity resolution requirements. Regardless of the pixel size, the Military i860 XR microprocessor always operates on 64 bits worth of pixels at a time. The pixel data type is used by two kinds of instructions:

- The selective pixel-store instruction that helps implement hidden surface elimination.
- The pixel add instruction that helps implement 3-D color intensity shading.

To perform color intensity shading efficiently in a variety of applications, the Military i860 XR microprocessor defines three pixel formats according to Table 2.1.

Figure 2.2 illustrates one way of assigning meaning to the fields of pixels. These assignments are for illustration purposes only. The Military i860 XR microprocessor defines only the field sizes, not the specific use of each field. Other ways of using the fields of pixels are possible.

**Table 2.1 Pixel Formats**

| Pixel Size (in bits) | Bits of Color 1 Intensity         | Bits of Color 2 Intensity | Bits of Color 3 Intensity | Bits of Other Attribute (Texture) |
|----------------------|-----------------------------------|---------------------------|---------------------------|-----------------------------------|
| 8                    | N ( $\leq 8$ ) bits of intensity* |                           |                           | 8 - N                             |
| 16                   | 6                                 | 6                         | 4                         | 0                                 |
| 32                   | 8                                 | 8                         | 8                         | 8                                 |

The intensity attribute fields may be assigned to colors in any order convenient to the application.

\*With 8-bit pixels, up to 8 bits can be used for intensity; the remaining bits can be used for any other attribute, such as color. The intensity bits must be the low-order bits of the pixel.

### 2.2 Register Set

As Figure 2.3 shows, the Military i860 XR microprocessor has the following registers:

- An integer register file
- A floating-point register file
- Six control registers (**psr**, **epsr**, **db**, **dirbase**, **fir** and **fsr**)
- Four special-purpose registers (KR, KI, T and MERGE)

The control registers are accessible only by load and store control-register instructions; the integer and floating-point registers are accessed by arithmetic operations and load and store instructions. The special-purpose registers KR, KI, T and MERGE are used by a few specific instructions.

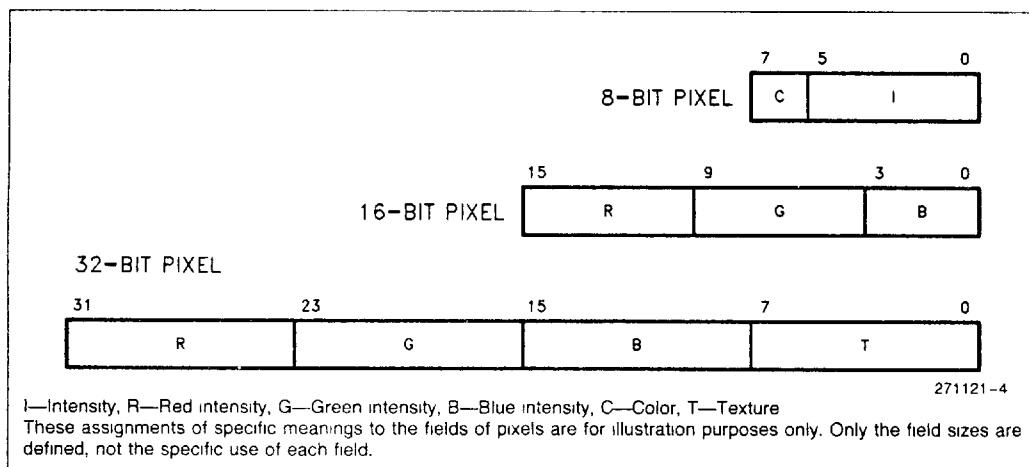

**Figure 2.2 Pixel Format Example**



### 2.2.1 INTEGER REGISTER FILE

There are 32 integer registers, each 32 bits wide, referred to as **r0** through **r31**, which are used for address computation and scalar integer computations. Register **r0** always returns zero when read, independently of what is stored in it. This special behavior of **r0** makes it useful for modifying the function of certain instructions.

### 2.2.2 FLOATING-POINT REGISTER FILE

There are 32 floating-point registers, each 32-bits wide, referred to as **f0** through **f31**, which are used for floating-point computations. Registers **f0** and **f1** always return zero when read, independently of what is stored in them. The floating-point registers are also used by a set of graphics operations, primarily for 3D graphics computations.

When accessing 64-bit floating-point or integer values, the Military i860 XR microprocessor uses an even/odd pair of registers. When accessing 128-bit values, it uses an aligned set of four contiguous registers (**f0**, **f4**, **f8**, . . . , **f28**). The instruction must designate the lowest register number of the set of registers containing 64- or 128-bit values. The register with the lowest number contains the least significant part of the value. For 128-bit values, the register pair with the lower numbers contain the least significant 64 bits while the register pair with the higher numbers contain the most significant 64 bits.

The 128-bit load and store instructions, along with the 128-bit data path between the floating-point registers and the data cache help to sustain the extraordinarily high rate of computation.

### 2.2.3 PROCESSOR STATUS REGISTER

The processor status register (**psr**) contains state information for the current process. Figure 2.4 shows the format of **psr**.

- **BR** (Break Read) and **BW** (Break Write) enable a data access trap when the operand address matches the address in the Data Breakpoint (**db**) register and a read or write (respectively) occurs.
- Various instructions set **CC** (Condition Code) according to tests they perform. The branch-on-condition-code instructions test its value. The Branch on CC and Add instruction sets and tests **LCC** (Loop Condition Code).
- **IM** (Interrupt Mode) enables external interrupts if set; disables interrupts if clear.
- **U** (User Mode) is set when the Military i860 XR microprocessor is executing in user mode; it is clear when the Military i860 XR microprocessor is executing in supervisor mode. In user mode, writes to some control registers are inhibited. This bit also controls the memory protection mechanism. See section 2.4.4.3 for a description of memory protection in user and supervisor modes.

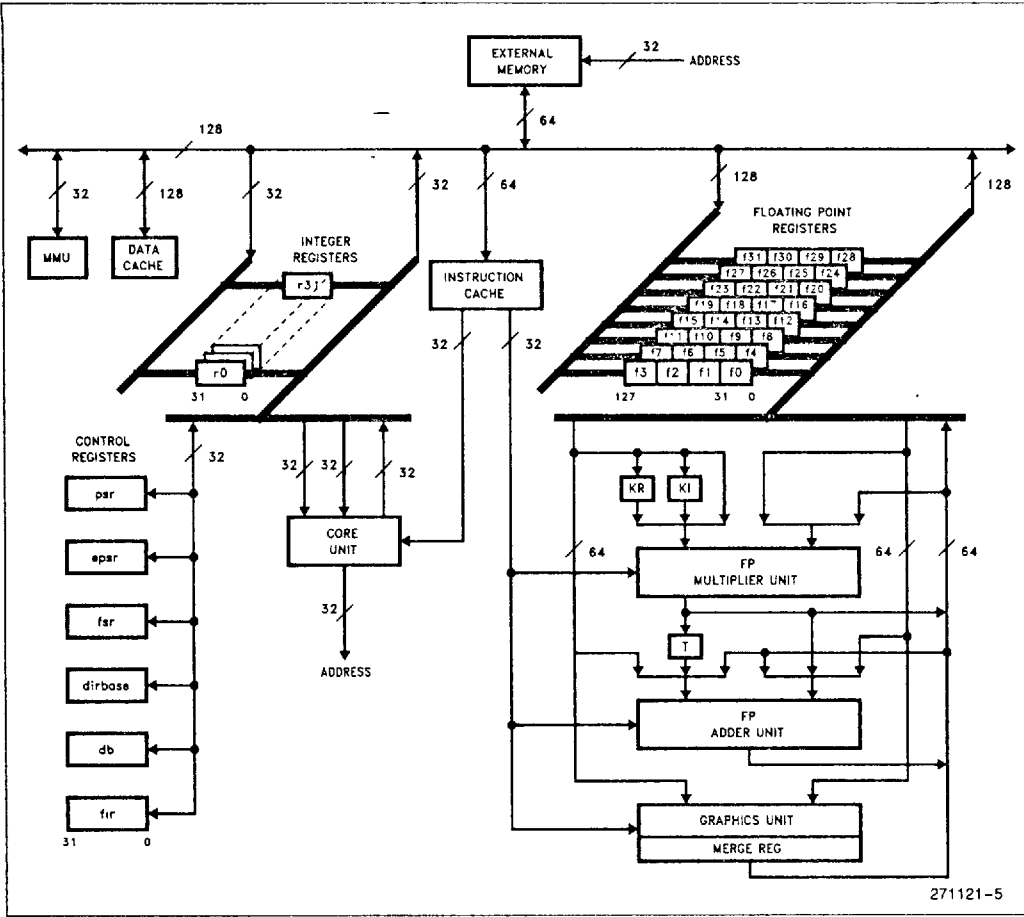

Figure 2.3 Registers and Data Paths



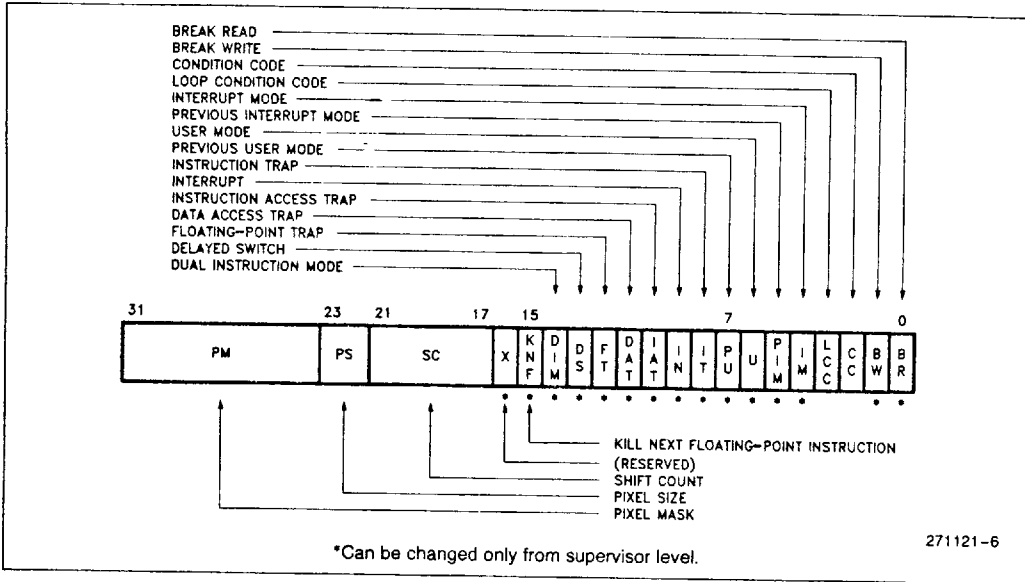

Figure 2.4 Processor Status Register (psr)

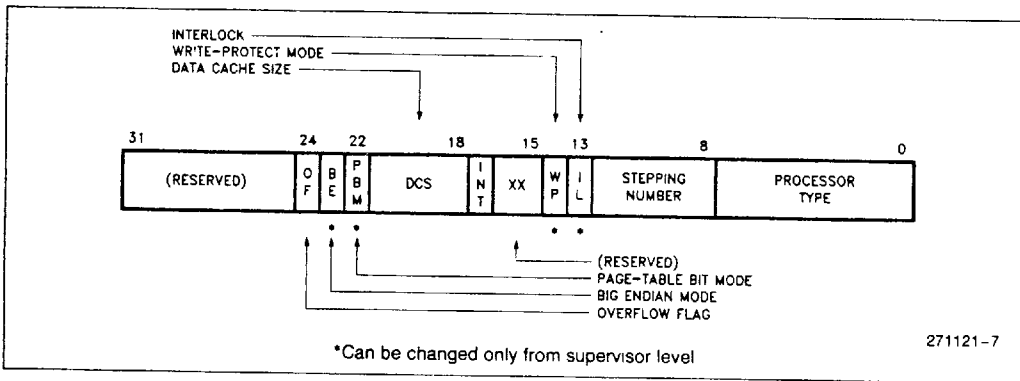

Figure 2.5 Extended Processor Status Register (epsr)

- PIM (Previous Interrupt Mode) and PU (Previous User Mode) save the corresponding status bits (IM and U) on a trap, because those status bits are changed when a trap occurs. They are restored into their previous state upon returning from a trap handler with a branch indirect instruction when a trap flag is set in the **psr**.
- FT (Floating-Point Trap), DAT (Data Access Trap), IAT (Instruction Access Trap), IN (Interrupt) and IT (Instruction Trap) are trap flags. They are set when the corresponding trap condition occurs. The trap handler examines these bits to determine which condition or conditions caused the trap.
- DS (Delayed Switch) is set if a trap occurs during the instruction before dual-instruction mode is entered or exited. If DS is set and DIM (Dual Instruction Mode) is clear, the Military i860 XR microprocessor switches to dual-instruction mode one instruction after returning from the trap handler. If DS and DIM are both set, the Military i860 XR microprocessor switches to single-instruction mode one instruction after returning from the trap handler.
- When a trap occurs, the Military i860 XR microprocessor sets DIM if it is executing in dual-instruction mode; it clears DIM if it is executing in single-instruction mode. If DIM is set after returning from a trap handler, the Military i860 XR microprocessor resumes execution in dual-instruction mode.

- When KNF (Kill Next Floating-Point Instruction) is set, the next floating-point instruction is suppressed (except that its dual-instruction mode bit is interpreted). A trap handler sets KNF if the trapped floating-point instruction should not be reexecuted.
- SC (Shift Count) stores the shift count used by the last right-shift instruction. It controls the number of shifts executed by the double-shift instruction.
- PS (Pixel Size) and PM (Pixel Mask) are used by the pixel-store instruction and by the graphics instructions. The values of PS control pixel size as defined by Table 2.2. The bits in PM correspond to pixels to be updated by the pixel-store instruction **pst.d**. The low-order bit of PM corresponds to the low-order pixel of the 64-bit source operand of **pst.d**. The number of low-order bits of PM that are actually used is the number of pixels that fit into 64-bits, which depends upon PS. If a bit of PM is set, then **pst.d** stores the corresponding pixel. Refer also to the **pst.d** instruction in Section 7.

Table 2.2 Values of PS

| Value | Pixel Size in bits | Pixel Size in bytes |
|-------|--------------------|---------------------|
| 00    | 8                  | 1                   |
| 01    | 16                 | 2                   |
| 10    | 32                 | 4                   |
| 11    | (undefined)        | (undefined)         |

2.2.4 EXTENDED PROCESSOR STATUS REGISTER

The extended processor status register (**epsr**) contains additional state information for the current process beyond that stored in **psr**. Figure 2.5 shows the format of **epsr**.

- The processor type is one (1) for the Military i860 XR microprocessor (Read Only field).
- The stepping number has a unique value that distinguishes among different revisions of the processor (Read Only field).
- IL (Interlock) is set if a trap occurs after a **lock** instruction but before the load or store following the subsequent **unlock** instruction. IL indicates to the trap handler that a locked sequence has been interrupted. When the trap handler finds IL set, it should scan backwards for the **lock** instruction and restart at that point. The absence of a **lock** instruction within 30–33 instructions of the trap indicates a programming error.
- WP (write protect) controls the semantics of the W bit of page table entries. A clear W bit in either the directory or the page table entry causes writes to be trapped. When WP is clear, writes are trapped in user mode, but not in supervisor mode. When WP is set, writes are trapped in both user and supervisor modes. After the value of the WP bit is changed, the TLB must be invalidated by setting the ITI bit of the **dirbase** register, before any stores are performed.
- INT (Interrupt) is the value of the INT input pin.
- DCS (Data Cache Size) is a read-only field that tells the size of the on-chip data cache. The number of bytes actually available is  $2^{12+DCS}$ ; therefore, a value of zero indicates 4 Kbytes, one indicates 8 Kbytes, etc. For the i860 processor, DCS = 1.

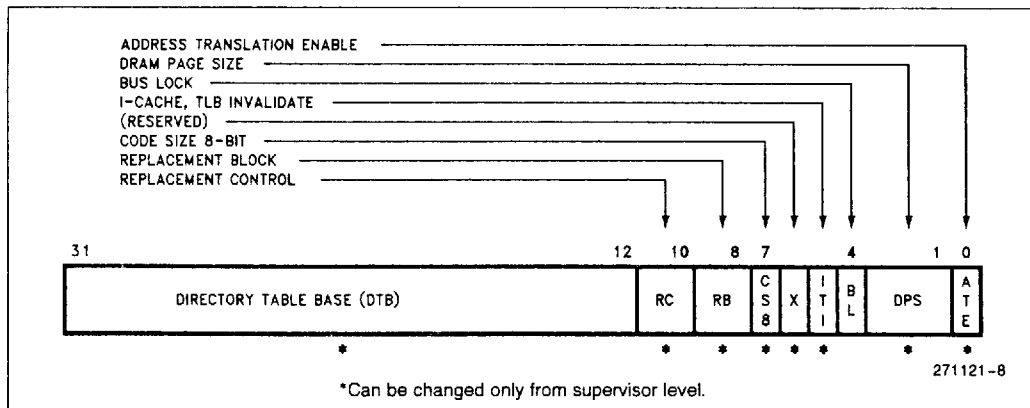

Figure 2.6 Directory Base Register (dirbase)

- PBM (Page-Table Bit Mode) determines which bit of page-table entries is output on the PTB pin. When PBM is clear, the PTB signal reflects bit CD of the page-table entry used for the current cycle. When PBM is set, the PTB signal reflects bit WT of the page-table entry used for the current cycle.
- BE (Big Endian) controls the ordering of bytes within a data item in memory. Normally (i.e. when BE is clear) the Military i860 XR microprocessor operates in little endian mode, in which the addressed byte is the low-order byte. When BE is set (big endian mode), the low-order three bits of all load and store addresses are complemented, then masked to the appropriate boundary for alignment. This causes the addressed byte to be the most significant byte. Section 2.3 discusses little and big endian addressing.
- OF (Overflow Flag) is set by **adds**, **addu**, **subs**, and **subu** when integer overflow occurs. For **adds** and **subs**, OF is set if the carry from bit 31 is different than the carry from bit 30. For **addu**, OF is set if there is a carry from bit 31. For **subu**, OF is set if there is no carry from bit 31. Under all other conditions, it is cleared by these instructions. OF controls the function of the **intovr** instruction.
- DPS (DRAM Page Size) controls how many bits to ignore when comparing the current bus-cycle address with the previous bus-cycle address to generate the  $\overline{NENE}$  signal. This feature allows for higher speeds when using static column or page-mode DRAMs and consecutive reads and writes access the same column or page. The comparison ignores the low-order  $12 + DPS$  bits. A value of zero is appropriate for one bank of  $256K \times n$  RAMs, one for  $1M \times n$  RAMS, etc.
- When BL (Bus Lock) is set, external bus accesses are locked. The  $\overline{LOCK}$  signal is asserted on the next bus cycle whose internal bus request is generated after BL is set. It remains asserted on all subsequent bus cycles as long as BL remains set. The  $\overline{LOCK}$  signal is deasserted on the next bus cycle whose internal bus request is generated after BL is cleared. Traps immediately clear BL. The **lock** and **unlock** instructions control the BL bit.
- ITI (I-Cache, TLB Invalidate), when set in the value being stored into **dirbase**, causes the instruction cache and address-translation cache (TLB) to be flushed. The ITI bit does not remain set in **dirbase**. ITI always appears as zero when reading **dirbase**. Section 2.5 discusses flushing the data cache before invalidating the TLB.

## 2.2.5 DATA BREAKPOINT REGISTER

The data breakpoint register (**db**) is used to generate a trap when the Military i860 XR microprocessor makes a data-operand access to the address stored in this register. The trap is enabled by BR and BW in **psr**. The **db** register can only be changed from supervisor level. When comparing, a number of low order bits of the address are ignored, depending on the size of the operand. For example, a 16-bit access ignores the low-order bit of the address when comparing to **db**; a 32-bit access ignores the two low-order bits. This ensures that any access that overlaps the address contained in the register will generate a trap. The data access trap occurs before the data is accessed and prevents the load or store from completing.

## 2.2.6 DIRECTORY BASE REGISTER

The directory base register **dirbase** (shown in Figure 2.6) controls address translation, caching, and bus options. The **dirbase** register can only be changed from the supervisor level. However, the BL bit can be changed from user level with the **lock** and **unlock** instructions.

- ATE (Address Translation Enable), when set, enables the virtual-address translation algorithm. The data cache must be flushed before changing the ATE bit.
- RC (Replacement Control) controls cache replacement algorithms. Table 2.4 explains the significance of the values of RC.
- DTB (Directory Table Base) contains the high-order 20 bits of the physical address of the page directory when address translation is enabled (i.e.  $ATE = 1$ ). The twelve low-order bits of the address are zeros.

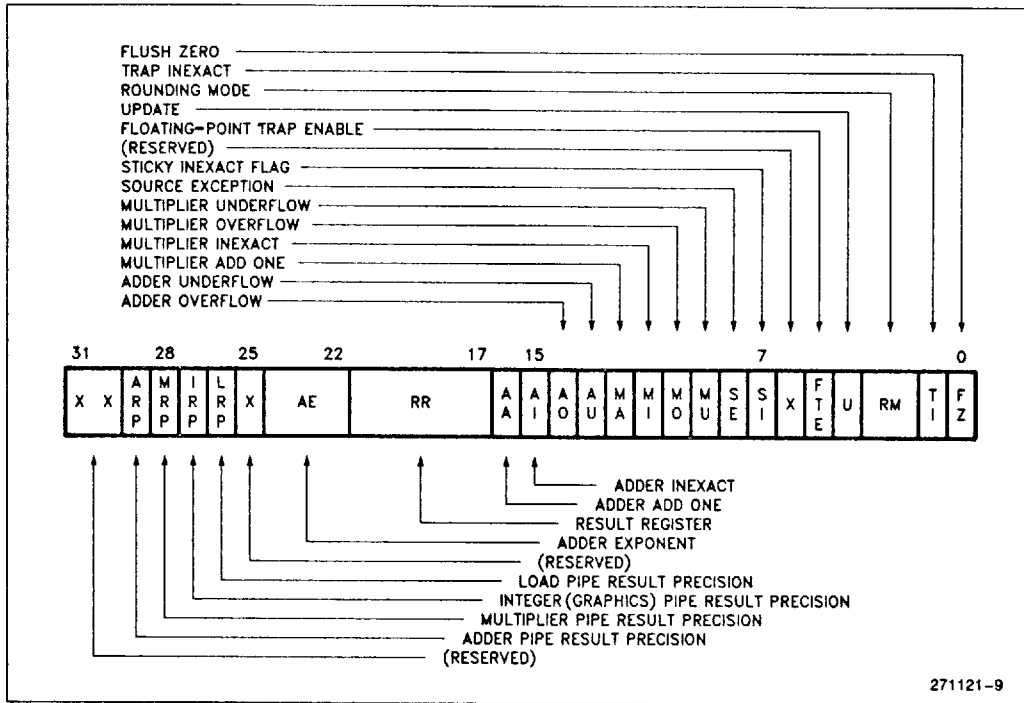

Figure 2.7 Floating-Point Status Register (fsr)

Table 2.3 Values of RB

| Value | Replace TLB Block | Replace Instruction and Data Cache Block |
|-------|-------------------|--|
| 0 0   | 0                 | 0  |
| 0 1   | 1                 | 1  |
| 1 0   | 2                 | 0  |
| 1 1   | 3                 | 1  |

Table 2.4 Values of RC

| Value | Meaning   |
|-------|---|
| 00    | Selects the normal replacement algorithm where any block in the set may be replaced on cache misses in all caches.  |
| 01    | Instruction, data, and TLB cache misses replace the block selected by RB. The instruction and data caches ignore the high-order bit of RB. This mode is used for instruction cache and TLB testing. |
| 10    | Data cache misses replace the block selected by the low-order bit of RB.  |
| 11    | Disables data cache replacement.  |

2.2.7 FAULT INSTRUCTION REGISTER

When a trap occurs, this register contains the address of the trapping instruction (not necessarily the instruction that created the conditions that required the trap). The fir is a read only register. The address of the *ld.c* instruction used to read the fir is returned in *rdest* when reading the fir at any time other than the first *ld.c* fir after a trap.

2.2.8 FLOATING-POINT STATUS REGISTER

The floating-point status register (fsr) contains the floating-point trap and rounding-mode status for the current process. Figure 2.7 shows its format. The fsr is writable in user level.

- If FZ (Flush Zero) is clear and underflow occurs, a result-exception trap is generated. When FZ is set and underflow occurs, the result is set to zero, and no trap due to underflow occurs.
- If TI (Trap Inexact) is clear, inexact results do not cause a trap. If TI is set, inexact results cause a trap. The sticky inexact flag (SI) is set whenever an inexact result is produced, regardless of the setting of TI.
- RM (Rounding Mode) specifies one of the four rounding modes defined by the IEEE standard. Given a true result *b* that cannot be represented



Table 2.5 Values of RM

| Value | Rounding Mode                  | Rounding Action  |
|-------|--------------------------------|--|
| 00    | Round to nearest or even       | Closer to <i>b</i> of <i>a</i> or <i>c</i> ; if equally close, select even number (the one whose least significant bit is zero). |
| 01    | Round down (toward $-\infty$ ) | <i>a</i>   |
| 10    | Round up (toward $+\infty$ )   | <i>c</i>   |
| 11    | Chop (toward zero)             | Smaller in magnitude of <i>a</i> or <i>c</i> .   |

by the target data type, the Military i860 XR microprocessor determines the two representable numbers *a* and *c* that most closely bracket *b* in value ( $a < b < c$ ). The Military i860 XR microprocessor then rounds (changes) *b* to *a* or *c* according to the mode selected by RM as defined in Table 2.5. Rounding introduces an error in the result that is less than one least-significant bit.

- The U-bit (Update Bit), if set in the value that is loaded into **fsr** by a **st.c** instruction, enables updating of the result-status bits (AE, AA, AI, AO, AU, MA, MI, MO and MU) in the first-stage of the floating-point adder and multiplier pipelines. If this bit is clear, the result-status bits are unaffected by a **st.c** instruction; **st.c** ignores the corresponding bits in the value that is being loaded. A **st.c** always updates **fsr** bits 21..17 and 8..0 directly. The U-bit does not remain set; it always appears as zero when read.
- The FTE (Floating-Point Trap Enable) bit, if clear, disables all floating-point traps (invalid input operand, overflow, underflow, and inexact result).
- SI (Sticky Inexact) is set when the last stage result of either the multiplier or adder is inexact (i.e. when either AI or MI is set). SI is "sticky" in the sense that it remains set until reset by software. AI and MI, on the other hand, can be changed by the subsequent floating-point instruction.
- SE (Source Exception) is set when one of the source operands of a floating-point operation is invalid; it is cleared when all the input operands are valid. Invalid input operands include denormals, infinities, and all NaNs (both quiet and signaling).
- When read from the **fsr**, the result-status bits MA, MI, MO, and MU (Multiplier Add-One, Inexact, Overflow and Underflow, respectively) describe the last stage result of the multiplier.

When read from the **fsr**, the result-status bits AA, AI, AO, AU, and AE (Adder Add-One, Inexact, Overflow, Underflow and Exponent, respectively) describe the last stage result of the adder. The high-order three bits of the 11-bit exponent of the adder result are stored in the AE field.

The Adder Add One and Multiplier Add One bits indicate that the absolute value of the result frac-

tion grew by one least-significant bit due to rounding. AA and MA are not influenced by the sign of the result.

After a floating-point operation in a given unit (adder or multiplier), the result-status bits of that unit are undefined until the point at which result exceptions are reported.

When written to the **fsr** with the U-bit set, the result-status bits are placed into the first stage of the adder and multiplier pipelines. When the processor executes pipelined operations, it propagates the result-status bits of a particular unit (multiplier or adder) one stage for each pipelined floating-point operation for that unit. When they reach the last stage, they replace the normal result-status bits in the **fsr**. When the U-bit is not set, result-status bits in the word being written to the **fsr** are ignored.

In a floating-point dual-operation instruction (e.g. add-and-multiply or subtract-and-multiply), both the multiplier and the adder may set exception bits. The result-status bits for a particular unit remain set until the next operation that uses that unit.

- RR (Result Register) specifies which floating-point register (**f0-f31**) was the destination register when a result-exception trap occurs due to a scalar operation.
- LRP (Load Pipe Result Precision), IRP (Integer (Graphics) Pipe Result Precision), MRP (Multiplier Pipe Result Precision) and ARP (Adder Pipe Result Precision) aid in restoring pipeline state after a trap or process switch. Each defines the precision of the last stage result in the corresponding pipeline. One of these bits is set when the result in the last stage of the corresponding pipeline is double precision; it is cleared if the result is single precision. These bits cannot be changed by software.

## 2.2.9 KR, KI, T AND MERGE REGISTERS

The KR, KI, and T registers are special-purpose registers used by the dual-operation floating-point instructions **pfam**, **pfmam**, **pfsm** and **pfmsm**, which





initiate both an adder (A-unit) operation and a multiplier (M-unit) operation. The KR, KI and T registers can store values from one dual-operation instruction and supply them as inputs to subsequent dual-operation instructions. (Refer to Figure 2.14.)

The MERGE register is used only by the graphics instructions. The purpose of the MERGE register is to accumulate (or merge) the results of multiple-addition operations that use as operands the color-intensity values from pixels or distance values from a Z-buffer. The accumulated results can then be stored in one 64-bit operation.

Two multiple-addition instructions and an OR instruction use the MERGE register. The addition instructions are designed to add interpolation values to each color-intensity field in an array of pixels or to each distance value in a Z-buffer.

Refer to the instruction descriptions in Section 7 for more information about these registers.

### 2.3 Addressing

Memory is addressed in byte units within a paged virtual-address space of  $2^{32}$  bytes. Data and instructions can be located anywhere in this address space. Address arithmetic is performed using 32-bit input values and produces 32-bit results. The low-order 32 bits of the result are used in case of overflow.

Normally, multibyte data values are stored in memory in little endian format, i.e., with the least significant byte at the lowest memory address. As an option, the ordering can be dynamically selected by software in supervisor mode. The Military i860 XR microprocessor also offers big endian mode, in which the most significant byte of a data item is at the lowest address. Figure 2.8 shows the difference between the two storage modes. Big endian and little endian data areas should not be mixed within a 64-bit data word. Illustrations of data structures in this data sheet show data stored in little endian mode, i.e., the rightmost (low-order) byte is at the lowest memory address.

Code accesses are always done with little endian addressing. This implies that code will appear differently than documented here when accessed as big endian data. Intel recommends that disassemblers running in a big endian system, convert instructions which have been read as data back to little endian form and present them in the format documented here.

Page directories and page tables are also accessed in little endian mode, regardless of the value of the BE bit.

Alignment requirements are as follows (any violation results in a data-access trap):

- 128-bit values are aligned on 16-byte boundaries when referenced in memory (i.e. the four least significant address bits must be zero).
- 64-bit values are aligned on 8-byte boundaries when referenced in memory (i.e. the three least significant address bits must be zero).
- 32-bit values are aligned on 4-byte boundaries when referenced in memory (i.e. the two least significant address bits must be zero).
- 16-bit values are aligned on 2-byte boundaries when referenced in memory (i.e. the least significant address bit must be zero).

### 2.4 Virtual Addressing

When address translation is enabled, the Military i860 XR microprocessor maps instruction and data virtual addresses into physical addresses before referencing memory. This address transformation is compatible with that of the Military 386 microprocessor and implements the basic features needed for page-oriented virtual-memory systems and page-level protection.

The address translation is optional. Address translation is in effect only when the ATE bit of **dirbase** is set. This bit is typically set by the operating system during software initialization. The ATE bit must be set if the operating system is to implement page-oriented protection or page-oriented virtual memory.





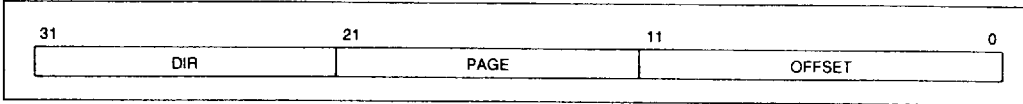

Figure 2.9 Format of a Virtual Address

Address translation is disabled when the processor is reset. It is enabled when a store to **dirbase** sets the ATE bit. It is disabled again when a store clears the ATE bit.

into a page directory, uses the PAGE field as an index into the page table determined by the page directory, and uses the OFFSET field to address a byte within the page determined by the page table.

2.4.1 PAGE FRAME

A **page frame** is a 4-Kbyte unit of contiguous addresses of physical main memory. Page frames begin on 4-Kbyte boundaries and are fixed in size. A **page** is the collection of data that occupies a page frame when that data is present in main memory. The data may also occupy some location in secondary storage when there is not sufficient space in main memory.

2.4.3 PAGE TABLES

A page table is simply an array of 32-bit page specifiers. A page table is itself a page, and therefore contains 4 Kbytes of memory or at most 1K 32-bit entries.

2.4.2 VIRTUAL ADDRESS

A virtual address refers indirectly to a physical address by specifying a page table, a page within that table, and an offset within that page. Figure 2.9 shows the format of a virtual address.

Two levels of tables are used to address a page of memory. At the higher level is a page directory. The page directory addresses up to 1K page tables of the second level. A page table of the second level addresses up to 1K pages. All the tables addressed by one page directory, therefore, can address 1M pages ( $2^{20}$ ). Because each page contains 4 Kbytes ( $2^{12}$  bytes), the tables of one page directory can span the entire physical address space of the Military i860 XR microprocessor ( $2^{20} \times 2^{12} = 2^{32}$ ).

Figure 2.10 shows how the Military i860 XR microprocessor converts the DIR, PAGE, and OFFSET fields into the physical address by consulting two levels of page tables. The addressing mechanism uses the DIR field as an index

The physical address of the current page directory is stored in DTB field of the **dirbase** register. Memory management software has the option of using one page directory for all processes, one page directory for each process, or some combination of the two.

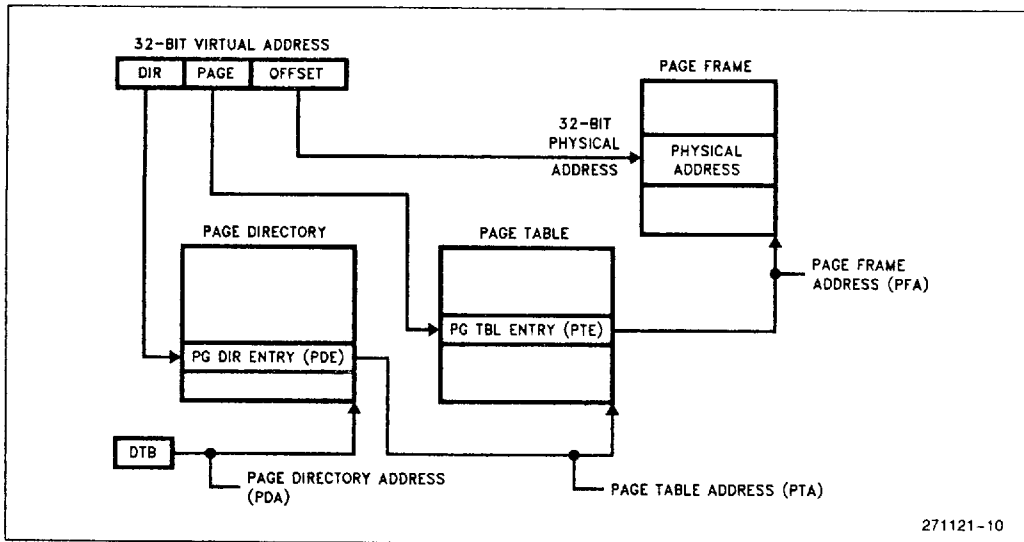

Figure 2.10 Address Translation

**2.4.4 TABLE ENTRIES**

Table entries in either level of page tables have the same general format. Figure 2.11 illustrates this format for a page-directory entry and a page-table entry.

**2.4.4.1 Page Frame Address Generation**

The page frame address specifies the physical starting address of a page. Because pages are located on 4K boundaries, the low-order 12 bits are always zero. In a page directory, the page table address is the address of a page table. In a second-level page table, the page frame address is the address of the page frame that contains the desired memory operand.

**2.4.4.2 Present Bit**

The P (present) bit indicates whether a page table entry can be used in address translation. P = 1 indicates that the entry can be used. When P = 0 in either level of page tables, the entry is not valid for address translation, and the rest of the entry is available for software use; none of the other bits in the entry are tested by the hardware. If P = 0 in either level of page tables when an attempt is made to use a page-table entry for address translation, the processor signals either a data-access fault or an in-

struction-access fault. In software systems that support paged virtual memory, the trap handler can bring the required page into physical memory.

Note that there is no P bit for the page directory itself. The page directory may be not-present while the associated process is suspended, but the operating system must ensure that the page directory indicated by the **dirbase** image associated with the process is present in physical memory before the process is dispatched.

**2.4.4.3 Writable and User Bits**

The W (writable) and U (user) bits are used for page-level protection, which the Military i860 XR microprocessor performs at the same time as address translation. The concept of privilege for pages is implemented by assigning each page to one of two levels:

1. Supervisor level (U = 0)—for the operating system and other systems software and related data.
2. User level (U = 1)—for applications procedures and data.

The U bit of the **psr** indicates whether the Military i860 XR microprocessor is executing at user or supervisor level. The Military i860 XR microprocessor maintains the U bit of **psr** as follows:

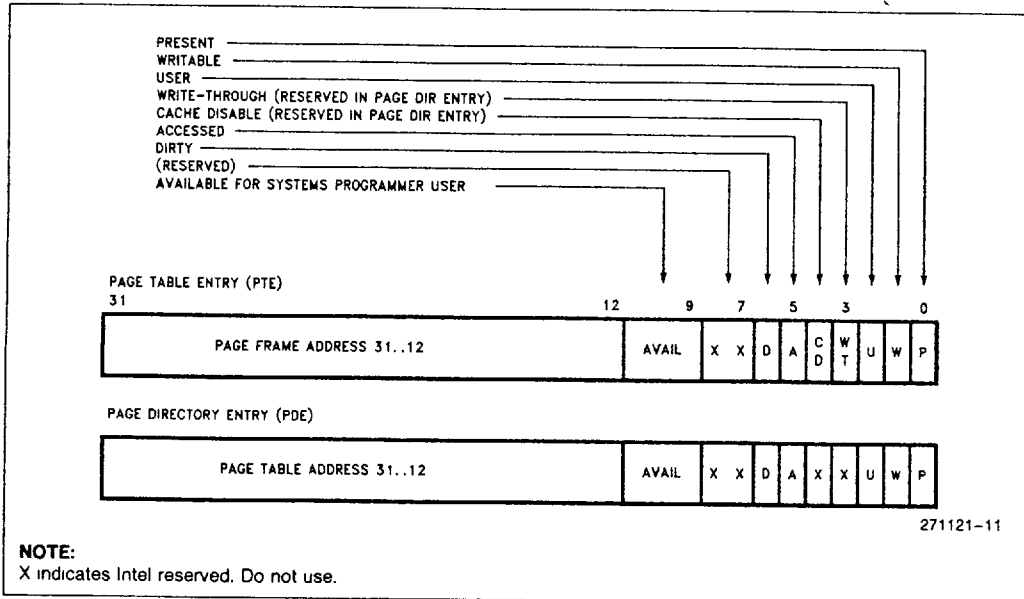

**Figure 2.11 Format of a Page-Table and Page-Directory Entry**

- The Military i860 XR microprocessor clears the **psr** U bit to indicate supervisor level when a trap occurs (including when the **trap** instruction causes the trap). The prior value of U is copied into PU.
- The Military i860 XR microprocessor copies the **psr** PU bit into the U bit when an indirect branch is executed and one of the trap bits is set. If PU was one, the Military i860 XR microprocessor enters user level.

With the U bit of **psr** and the W and U bits of the page table entries, the Military i860 XR microprocessor implements the following protection rules:

- When at user level, a read or write of a supervisor-level page causes a trap.
- When at user level, a write to a page whose W bit is clear causes a trap.
- When at user level, **st.c** to certain control registers is ignored.

When the Military i860 XR microprocessor is executing at supervisor level, all pages are addressable, but, when it is executing at user level, only pages that belong to the user-level are addressable.

When the Military i860 XR microprocessor is executing at supervisor level, all pages are readable. Whether a page is writable depends upon the write-protection mode controlled by WP bit of **epsr**.

- WP = 0 All pages are writable.
- WP = 1 A write to a page whose W bit is clear causes a trap.

When the Military i860 XR microprocessor is executing at user level, only pages that belong to user level and are marked writable are actually writable; pages that belong to supervisor level are neither readable nor writable from user level.

**2.4.4.4 Write-Through Bit**

The Military i860 XR microprocessor does not implement a write-through caching policy for the on-chip data cache; however, the WT (write-through) bit in the second-level page-table entry does determine internal caching policy. If WT is set in a PTE, on-chip caching of data from the corresponding page is inhibited. The Military i860 CPU may place pages having WT = 1 into the instruction cache. Future implementations of the Military i860 architecture may adhere to a write-through data caching policy. Therefore, they may cache pages having the WT bit of the PTE set. If WT is clear, the normal write-back policy is applied to data from the page in the on-chip caches. The WT bit of page directory entries is not referenced by the processor, but is **reserved**.

The WT bit is independent of the CD bit; therefore, data may be placed in a second-level coherent cache, but kept out of the on-chip caches.

**2.4.4.5 Cache Disable Bit**

If the CD (cache disable) bit in the second-level page-table entry is set, data from the associated page is not placed in instruction or data caches. Clearing CD permits the cache hardware to place data from the associated page into caches. The CD bit of page directory entries is not referenced by the processor, but is **reserved**.

To control external caches, the Military i860 XR microprocessor outputs on its PTB pin either the CD or WT bit. The PBM bit of **epsr** determines which bit is output.

**2.4.4.6 Accessed and Dirty Bits**

The A (accessed) and D (dirty) bits provide data about page usage in both levels of the page tables.

The Military i860 XR microprocessor sets the corresponding accessed bits in both levels of page tables before a read or write operation to a page. The processor tests the dirty bit in the second-level page table before a write to an address covered by that page table entry, and, under certain conditions, causes traps. The trap handler then has the opportunity to maintain appropriate values in the dirty bits. The dirty bit in directory entries is not tested by the Military i860 XR microprocessor. The precise algorithm for using these bits is specified in Section 2.4.5.

An operating system that supports paged virtual memory can use these bits to determine what pages to eliminate from physical memory when the demand for memory exceeds the physical memory available. The D and A bits in the PDE (Page-Directory Entry) or the PTE (Page-Table Entry) are normally initialized to zero by the operating system. The processor sets the A bit when a page is accessed either by a read or write operation. When a data- or instruction-access fault occurs, the trap handler sets the D bit if an allowable write is being performed, then re-executes the instruction.

The operating system is responsible for coordinating its updates to the accessed and dirty bits with updates by the CPU and by other processors that may share the page tables. The Military i860 XR microprocessor automatically asserts the **LOCK** signal while setting the A bit. If an A-bit of a PTE is found not set during a locked sequence (created by the **lock** instruction), a trap will occur and the processor will not update the A-bit.



**2.4.4.7 Combining Protection of Both Levels of Page Tables**

For any one page, the protection attributes of its page directory entry may differ from those of its page table entry. The Military i860 XR microprocessor computes the effective protection attributes for a



page by examining the protection attributes in both the directory and the page table. Table 2.6 shows the effective protection provided by the possible combinations of protection attributes.

**2.4.5 ADDRESS TRANSLATION ALGORITHM**

Referring to Figure 2-10, the algorithm below defines the translation of each virtual address to a physical address. Let DIR, PAGE, and OFFSET be the fields of the virtual address; let PTA be the page table address and PFA be the page frame address of the first and second level page tables respectively; DTB is the page directory table base address stored in the **dirbase** register.

1. Read the PDE (Page Directory Entry) at the physical address formed by DTB:DIR:00.
2. If P in the PDE is zero, generate a data- or instruction-access fault.
3. If W in the PTE is zero, the operation is a write, and either the U-bit of the PSR is set or WP = 1, generate a data or instruction access fault.
4. If the U-bit in the PDE is zero and the U-bit in the **psr** is set, generate a data or instruction access fault.

5. If A in the PDE is zero, and if the TLB miss occurred while the bus was locked, generate a data or instruction access fault. (The trap allows software to set A to one and restart the sequence. This avoids ambiguity in determining what address corresponds to a locked semaphore for external bus hardware use.)
6. If A in the PDE is zero, and if the TLB miss occurred while the bus was not locked, assert LOCK. Re-fetch and check the PDE, set A, and store the PDE. Deassert LOCK during the store.
7. Locate the PTE (Page Table Entry) at the physical address formed by PTA:PAGE:00.
8. Perform the P, W, U and A checks as in steps 2 through 6 with the second-level PTE.
9. If D in the PTE is clear and the operation is a write, generate a data or instruction access fault.
10. Form the physical address as PFA:OFFSET.

The Military i860 XR microprocessor looks only in external memory for Page Directories and Page Tables, in the translation process. The data cache is not searched. Therefore, any code which modifies Page Directories or Page Tables must keep them out of the cache. The tables should be kept in non-cacheable memory, or flushed from the cache.

**Table 2.6 Combining Directory and Page Protections**

| Page Directory Entry |       | Page Table Entry |       | Combined Protection |                   |        |
|----------------------|-------|------------------|-------|---------------------|-------------------|--------|
|                      |       |                  |       | User Access         | Supervisor Access |        |
| U-bit                | W-bit | U-bit            | W-bit | WP = X              | WP = 0            | WP = 1 |
| 0                    | 0     | 0                | 0     | N                   | R/W               | R      |
| 0                    | 0     | 0                | 1     | N                   | R/W               | R      |
| 0                    | 0     | 1                | 0     | N                   | R/W               | R      |
| 0                    | 0     | 1                | 1     | N                   | R/W               | R      |
| 0                    | 1     | 0                | 0     | N                   | R/W               | R      |
| 0                    | 1     | 0                | 1     | N                   | R/W               | R/W    |
| 0                    | 1     | 1                | 0     | N                   | R/W               | R      |
| 0                    | 1     | 1                | 1     | N                   | R/W               | R/W    |
| 1                    | 0     | 0                | 0     | N                   | R/W               | R      |
| 1                    | 0     | 0                | 1     | N                   | R/W               | R      |
| 1                    | 0     | 1                | 0     | R                   | R/W               | R      |
| 1                    | 0     | 1                | 1     | R                   | R/W               | R      |
| 1                    | 1     | 0                | 0     | N                   | R/W               | R      |
| 1                    | 1     | 0                | 1     | N                   | R/W               | R/W    |
| 1                    | 1     | 1                | 0     | R                   | R/W               | R      |
| 1                    | 1     | 1                | 1     | R/W                 | R/W               | R/W    |

**NOTES:**  
 N = No access allowed      R/W = Both reads and writes allowed  
 R = Read access only      X = Don't care



The Military i860 XR microprocessor expects Page Directories and Page Tables to be in little endian format. The operating system must maintain these tables in little endian format by either setting BE = 0 when manipulating the tables or by complementing bit 2 of the address when loading or storing entries.

### 2.4.6 ADDRESS TRANSLATION FAULTS

The address translation fault is one instance of the data-access fault. The instruction causing the fault can be re-executed upon returning from the trap handler.

### 2.4.7 PAGE TRANSLATION CACHE

For greatest efficiency in address translation, the Military i860 XR microprocessor stores the most recently used page-table data in an on-chip cache called the TLB (translation lookaside buffer). Only if the necessary paging information is not in the cache must both levels of page tables be referenced.

## 2.5 Caching and Cache Flushing

The Military i860 XR microprocessor has the ability to cache instruction, data, and address-translation information in on-chip caches. Caching uses virtual-address tags. The effects of mapping two different virtual addresses in the same address space to the same physical address are undefined.

Instruction, data and address-translation caching on the i860 XR microprocessor are not transparent. Because the data cache uses a write-back protocol, writes do not immediately update memory, and writes to memory by other bus devices do not update the cache. Changes to page tables do not automatically update the TLB, and changes to instructions do not automatically update the instruction cache. Under certain circumstances, such as I/O references, self-modifying code, page-table updates or shared data in a multiprocessing system, it is necessary to bypass or to flush the caches. The Military i860 XR microprocessor provides the following methods for doing this:

- **Bypassing Instruction and Data Caches.** If deasserted during cache-miss processing, the KEN pin disables instruction and data caching of the referenced data. If the CD bit of the associat-

ed second-level PTE is set, caching of data and instructions is disabled. The Military i860 CPU may place pages having WT = 1 into the instruction cache. Future implementations of the Military i860 architecture may adhere to a write-through data cache policy. Thus, they may cache pages having the WT bit of the PTE set. The value of the CD bit or the WT bit is output on the PTB pin for use by external caches.

- **Flushing Instruction and Address-Translation Caches.** Storing to the **dirbase** register with the ITI bit set invalidates the contents of the instruction and address-translation caches. This bit should be set when a page table or a page containing code is modified or when changing the DTB field of **dirbase**. Note that in order to make the instruction or address-translation caches consistent with the data cache, the data cache must be flushed *before* invalidating the other caches. The mapping of the page containing the currently executing instruction and the next six instructions should not be different in the new page tables when **st.c dirbase** changes DTB or activates ITI. The six instructions following the **st.c** should be **nops** and should lie in the same page as the **st.c**.
- **Flushing the Data Cache.** The data cache is flushed by a software routine using the **flush** instruction. The data cache must be flushed prior to flushing the instruction or address-translation caches (as controlled by the ITI bit of **dirbase**) or enabling or disabling address translation (via the ATE bit). The data cache does not need flushing if the program is modifying only the P, U, W, A, or D bits of a PDE or PTE (as long as the Page Table or Page Frame Address is not changed and the entry itself was not in the data cache.) The Military i860 CPU does not check these protection bits on cache line writeback. Thus, a trap handler can service a Data Access Fault for D-bit-zero by setting D = 1 and then ITI = 1. In the case of setting the P or A bits active, there is no need to invalidate or flush any caches because the processor does not load entries into the TLB that have P = 0 or A = 0. The Military i860 XR microprocessor searches only external memory for Page Directories and Page Tables in the translation process. The data cache is not searched. Therefore, Page Tables and Directories should be kept in non-cacheable memory, or flushed from the cache by any code which accesses them.



PRELIMINARY

## 2.6 Instruction Set

Table 2.7 shows the complete set of instructions grouped by function and data type. Refer to Section 7 for an algorithmic definition of each instruction.

The architecture of the Military i860 XR microprocessor uses parallelism to increase the rate at which operations may be introduced into the unit. Parallelism in the Military i860 XR microprocessor is **not** transparent; rather, programmers have complete control over parallelism and therefore can achieve maximum performance for a variety of computational problems.

### 2.6.1 PIPELINED AND SCALAR OPERATIONS

One type of parallelism used within the floating-point unit is "pipelining". The pipelined architecture treats each operation as a series of more primitive operations (called "stages") that can be executed in parallel. Consider just the floating-point adder unit as an example. Let **A** represent the operation of the adder. Let the stages be represented by **A<sub>1</sub>**, **A<sub>2</sub>**, and **A<sub>3</sub>**. The stages are designed such that **A<sub>j+1</sub>** for one adder instruction can execute in parallel with **A<sub>j</sub>** for the next adder instruction. Furthermore, each **A<sub>j</sub>** can be executed in just one clock. The pipelining within the multiplier and graphics units can be described similarly, except that the number of stages may be different.

Figure 2.12 illustrates three-stage pipelining as found in the floating-point adder (also in the floating-point multiplier when single-precision input operands are employed). The columns of the figure represent the three stages of the pipeline. Each stage holds intermediate results and also (when introduced into first stage by software) holds status information pertaining to those results. The figure assumes that the instruction stream consists of a series of consecutive floating-point instructions, all of one type (i.e. all adder instructions or all single-precision multiplier instructions). The instructions are represented as **I**, **I + 1**, etc. The rows of the figure represent the states of the unit at successive clock cycles. Each time a pipelined operation is performed, the result of the last stage of the pipeline is stored in the destination register *fdest*, the pipeline is advanced one stage, and the input operands *src1* and *src2* are transferred to the first stage of the pipeline.

In the Military i860 XR microprocessor, the number of pipeline stages ranges from one to three. A pipelined operation with a three-stage pipeline stores the result of the third prior operation. A pipelined operation with a two-stage pipeline stores the result of the second prior operation. A pipelined operation with a one-stage pipeline stores the result of the prior operation.

There are four floating-point pipelines: one for the multiplier, one for the adder, one for the graphics unit, and one for floating-point loads. The adder pipeline has three stages. The number of stages in the multiplier pipeline depends on the precision of the source operands in the pipeline. Single precision has three stages and double precision has two stages. The graphics unit has one stage for all precisions. The load pipeline has three stages for all precisions.

Changing the FZ (flush zero), RM (rounding mode), or RR (result register) bits of **fsr** while there are results in either the multiplier or adder pipeline produces effects that are not defined.

#### 2.6.1.1 Scalar Mode

In addition to the pipelined execution mode, the Military i860 XR microprocessor also can execute floating-point instructions in "scalar" mode. Most floating-point instructions have both pipelined and scalar variants, distinguished by a bit in the instruction encoding. In scalar mode, the floating-point unit does not start a new operation until the previous floating-point operation is completed. The scalar operation passes through all stages of its pipeline before a new operation is introduced, and the result is stored automatically. Scalar mode is used when the next operation depends on results from the previous floating-point operations (or when the compiler or programmer does not want to deal with pipelining).

#### 2.6.1.2 Pipelining Status Information

Result status information in the **fsr** consists of the AA, AI, AO, AU and AE bits, for the adder, and the MA, MI, MO and MU bits, for the multiplier. This information arrives at the **fsr** via the pipeline in one of two ways:



**Table 2.7 Instruction Set**

| Core Unit                              |                                   |
|--|-----------------------------------|
| Mnemonic                               | Description                       |
| <b>Load and Store Instructions</b>     |                                   |
| ld.x                                   | Load integer                      |
| st.x                                   | Store integer                     |
| fld.y                                  | F-P load                          |
| pfld.z                                 | Pipelined F-P load                |
| fst.y                                  | F-P store                         |
| pst.d                                  | Pixel store                       |
| <b>Register to Register Moves</b>      |                                   |
| ixfr                                   | Transfer integer to F-P register  |
| fxfr                                   | Transfer F-P to integer register  |
| <b>Integer Arithmetic Instructions</b> |                                   |
| addu                                   | Add unsigned                      |
| adds                                   | Add signed                        |
| subu                                   | Subtract unsigned                 |
| subs                                   | Subtract signed                   |
| <b>Shift Instructions</b>              |                                   |
| shl                                    | Shift left                        |
| shr                                    | Shift right                       |
| shra                                   | Shift right arithmetic            |
| shrd                                   | Shift right double                |
| <b>Logical Instructions</b>            |                                   |
| and                                    | Logical AND                       |
| andh                                   | Logical AND high                  |
| andnot                                 | Logical AND NOT                   |
| andnoth                                | Logical AND NOT high              |
| or                                     | Logical OR                        |
| orh                                    | Logical OR high                   |
| xor                                    | Logical exclusive OR              |
| xorh                                   | Logical exclusive OR high         |
| <b>Control-Transfer Instructions</b>   |                                   |
| trap                                   | Software trap                     |
| intovr                                 | Software trap on integer overflow |
| br                                     | Branch direct                     |
| bri                                    | Branch indirect                   |
| bc                                     | Branch on CC                      |
| bc.t                                   | Branch on CC taken                |
| bnc                                    | Branch on not CC                  |
| bnc.t                                  | Branch on not CC taken            |
| bte                                    | Branch if equal                   |
| btne                                   | Branch if not equal               |
| bla                                    | Branch on LCC and add             |
| call                                   | Subroutine call                   |
| calli                                  | Indirect subroutine call          |
| <b>System Control Instructions</b>     |                                   |
| flush                                  | Cache flush                       |
| ld.c                                   | Load from control register        |
| st.c                                   | Store to control register         |
| lock                                   | Begin interlocked sequence        |
| unlock                                 | End interlocked sequence          |

| Floating-Point Unit                |                                      |
|------------------------------------|--------------------------------------|
| Mnemonic                           | Description                          |
| <b>F-P Multiplier Instruction</b>  |                                      |
| fmul.p                             | F-P multiply                         |
| pfmul.p                            | Pipelined F-P multiply               |
| pfmul3.dd                          | 3-Stage pipelined F-P multiply       |
| fmulow.p                           | F-P multiply low                     |
| frcp.p                             | F-P reciprocal                       |
| frsqr.p                            | F-P reciprocal square root           |
| <b>F-P Adder Instructions</b>      |                                      |
| fadd.p                             | F-P add                              |
| pfadd.p                            | Pipelined F-P add                    |
| famov.r                            | F-P adder move                       |
| pfamov.r                           | Pipelined F-P adder move             |
| fsub.p                             | F-P subtract                         |
| pfsub.p                            | Pipelined F-P subtract               |
| pfgt.p                             | Pipelined F-P greater-than compare   |
| pfeq.p                             | Pipelined F-P equal compare          |
| fix.p                              | F-P to integer conversion            |
| pfix.p                             | Pipelined F-P to integer conversion  |
| ft trunc.p                         | F-P to integer truncation            |
| pftrunc.p                          | Pipelined F-P to integer truncation  |
| <b>Dual-Operation Instructions</b> |                                      |
| pfam.p                             | Pipelined F-P add and multiply       |
| pfsm.p                             | Pipelined F-P subtract and multiply  |
| pfmam.p                            | Pipelined F-P multiply with add      |
| pfmsm.p                            | Pipelined F-P multiply with subtract |
| <b>Long Integer Instructions</b>   |                                      |
| fisub.z                            | Long-integer subtract                |
| pfisub.z                           | Pipelined long-integer subtract      |
| fiadd.z                            | Long-integer add                     |
| pfisub.z                           | Pipelined long-integer add           |
| <b>Graphics Instructions</b>       |                                      |
| fzchks                             | 16-bit Z-buffer check                |
| pfzchks                            | Pipelined 16-bit Z-buffer check      |
| fzchkl                             | 32-bit Z-buffer check                |
| pfzchkl                            | Pipelined 32-bit Z-buffer check      |
| faddp                              | Add with pixel merge                 |
| pfaddp                             | Pipelined add with pixel merge       |
| faddz                              | Add with Z merge                     |
| pfaddz                             | Pipelined add with Z merge           |
| form                               | OR with MERGE register               |
| pfom                               | Pipelined OR with MERGE register     |

| Assembler Pseudo-Operations |                                  |
|-----------------------------|----------------------------------|
| Mnemonic                    | Description                      |
| mov                         | Integer register-register move   |
| fmov.r                      | F-P reg-reg move                 |
| pfmov.r                     | Pipelined F-P reg-reg move       |
| nop                         | Core no-operation                |
| fnop                        | F-P no-operation                 |
| pfle.p                      | Pipelined F-P less-than or equal |



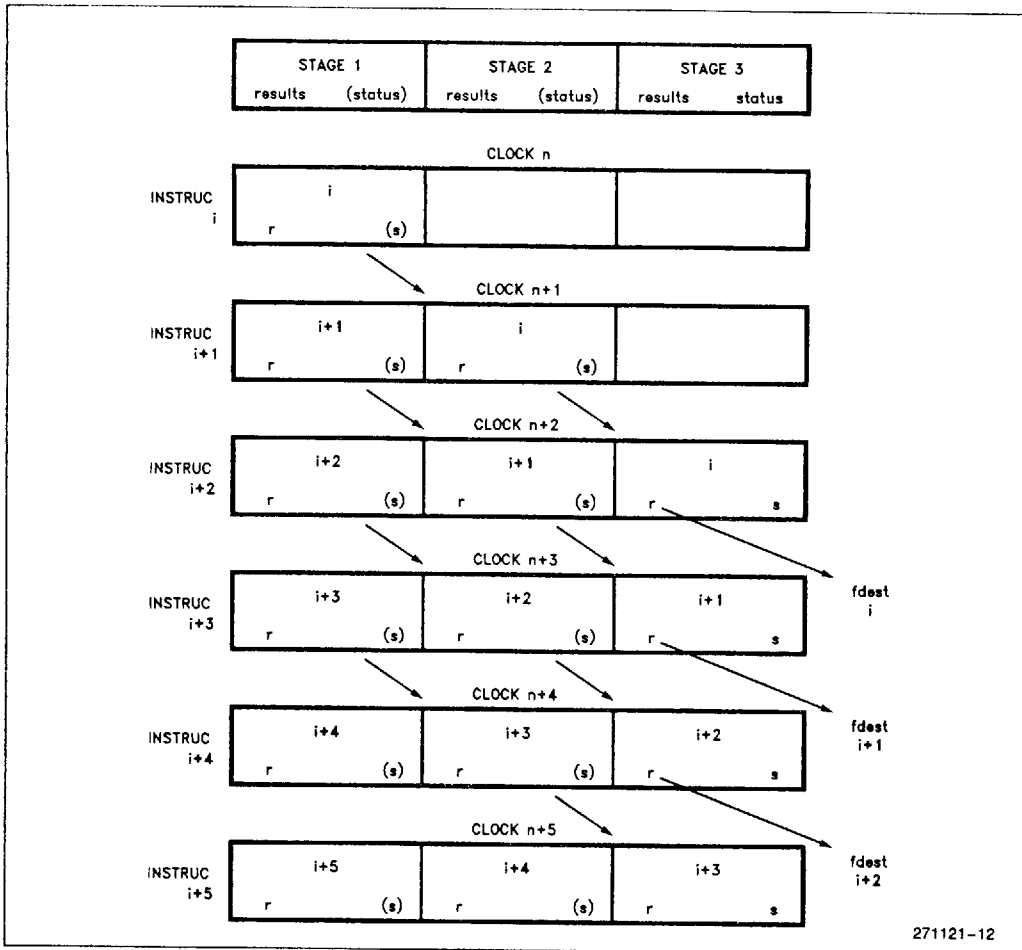

Figure 2.12 FP-Adder Pipelined Instruction Execution

1. It is calculated by the last stage of the pipeline. (This is the normal case.)
2. It is propagated from the first stage of the pipeline. This method is used when restoring the state of the pipeline after a preemption. When a store instruction updates the **fsr** with the U bit in the word being written into the **fsr** set, the store updates the result status bits in the first stage of both the adder and multiplier pipelines. When software changes the result-status bits of the first stage of a particular unit (multiplier or adder), the updated result-status bits are propagated one stage for each pipelined floating-point operation for that unit. In this case, each stage of the adder and multiplier pipelines holds its own copy of the relevant bits of the **fsr**. When they reach the last stage, they override the normal result-status bits computed from the last stage result.

At the next floating-point instruction (or at certain core instructions), after the result reaches the last stage, the Military i860 XR microprocessor traps if any of the status bits of the **fsr** indicate exceptions. Note that the instruction that creates the exception condition is not the instruction at which the trap occurs.

### 2.6.1.3 Precision in the Pipelines

In pipelined mode, when a floating-point operation is initiated, the result of an earlier pipelined floating-point operation is returned. The result precision of the current instruction applies to the operation being initiated. The precision of the value stored in **fdest** is that which was specified by the instruction that initiated that operation.

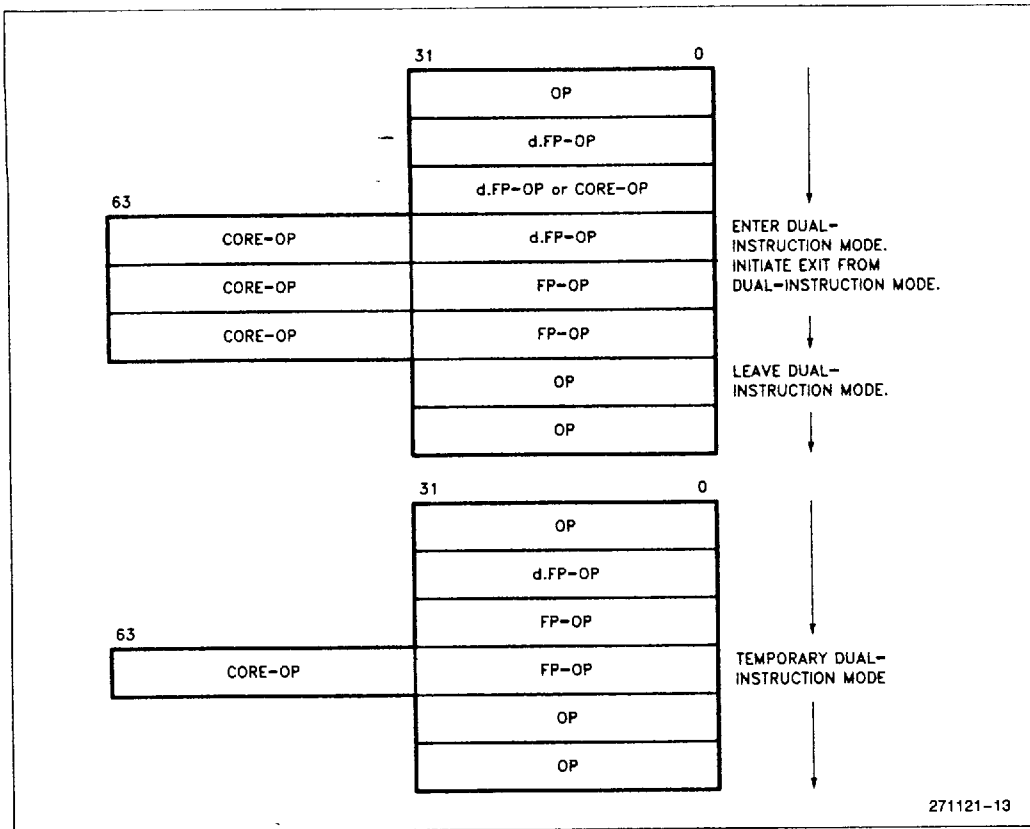

Figure 2.13 Dual-Instruction Mode Transitions

If *fdest* is the same as *fsrc1* or *fsrc2*, the value being stored in *fdest* is used as the input operand. In this case, the precision of *fdest* must be the same as the source precision.

The multiplier pipeline has two stages when the source operand is double-precision and three stages when the source operand is single-precision. This means that a pipelined multiplier operation stores the result of the second previous multiplier operation for double-precision inputs and third previous for single-precision inputs (except when changing precisions).

**2.6.1.4 Transition between Scalar and Pipelined Operations**

When a scalar operation is executed, it passes through all stages of the pipeline; therefore, any un-stored results in the affected pipeline are lost. To avoid losing information, the last pipelined operations before a scalar operation should be dummy pipelined operations that unload un-stored results from the affected pipeline.

After a scalar operation, the values of all pipeline stages of the affected unit (except the last) are undefined. No spurious result-exception traps result when the undefined values are subsequently stored by pipelined operations; however, the values should not be referenced as source operands.

For best performance a scalar operation should not immediately precede a pipelined operation whose *fdest* is nonzero.

**2.6.2 DUAL-INSTRUCTION MODE**

Another form of parallelism results from the fact that the Military i860 XR microprocessor can simultaneously execute both a floating-point and a core instruction. Such parallel execution is called dual-instruction mode. When executing in dual-instruction mode, the instruction sequence consists of 64-bit aligned instructions with a floating-point instruction in the lower 32 bits and a core instruction in the upper 32 bits. Table 2.7 identifies which instructions are executed by the core unit and which by the floating-point unit.





Programmers specify dual-instruction mode either by including in the mnemonic of a floating-point instruction a **d.** prefix or by using the Assembler directives **.dual . . . .enddual**. Both of the specifications cause the D-bit of floating-point instructions to be set. If the Military i860 XR microprocessor is executing in single-instruction mode and encounters a floating-point instruction with the D-bit set, one more 32-bit instruction is executed before dual-mode execution begins. If the Military i860 XR microprocessor is executing in dual-instruction mode and a floating-point instruction is encountered with a clear D-bit, then one more pair of instructions is executed before resuming single-instruction mode. Figure 2.13 illustrates two variations of this sequence of events: one for extended sequences of dual-instructions and one for a single instruction pair.

When a 64-bit dual-instruction pair sequentially follows a delayed branch instruction in dual-instruction mode, both 32-bit instructions are executed.

**2.6.3 DUAL-OPERATION INSTRUCTIONS**

Special dual-operation floating-point instructions (add-and-multiply, subtract-and-multiply) use both the multiplier and adder units within the floating-point unit in parallel to efficiently execute such common tasks as evaluating systems of linear equations, performing the Fast Fourier Transform (FFT), and performing graphics transformations.

The instructions **pfam fsrc1, fsrc2, fdest** (add and multiply), **pfsm fsrc1, fsrc2, fdest** (subtract and multiply), **pfmam fsrc1, fsrc2, fdest** (multiply and add) and **pfmsm fsrc1, fsrc2, fdest** (multiply and subtract) initiate both an adder operation and a multiplier operation. Six operands are required, but the instruction format specifies only three operands; therefore, there are special provisions for specifying the operands. These special provisions consist of:

- Three special registers (KR, KI, and T), that can store values from one dual-operation instruction and supply them as inputs to subsequent dual-operation instructions.
  1. The constant registers KR and KI can store the value of *fsrc1* and subsequently supply that value to the multiplier pipeline in place of *fsrc1*.
  2. The transfer register T can store the last stage result of the multiplier pipeline and subsequently supply that value to the adder pipeline in place of *fsrc1*.
- A four-bit data-path control field in the opcode (DPC) that specifies the operands and loading of the special registers.
  1. Operand-1 of the multiplier can be KR, KI, or *fsrc1*.
  2. Operand-2 of the multiplier can be *fsrc2* or the last stage result of the adder pipeline.

3. Operand-1 of the adder can be *fsrc1*, the T-register or the last stage result of the adder pipeline.
4. Operand-2 of the adder can be *fsrc2*, the last stage result of the multiplier pipeline or the last stage result of the adder pipeline.

Figure 2.14 shows all the possible data paths surrounding the adder and multiplier. A DPC field in these instructions select different data paths. Table 7.8 shows the various encodings of the DPC field.

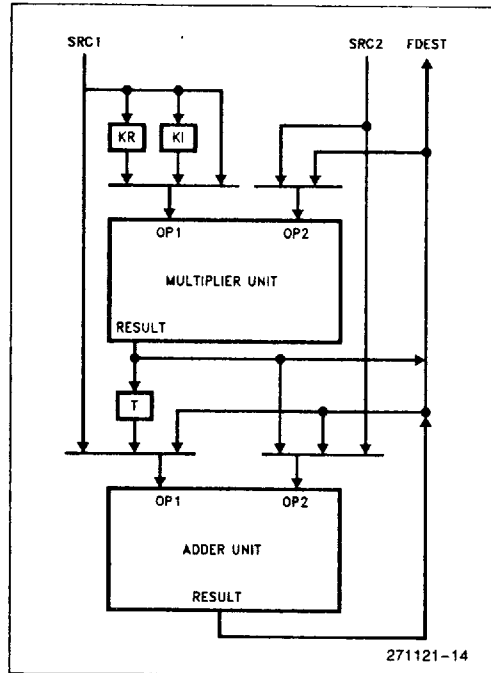

**Figure 2.14 Dual-Operation Data Paths**

Note that the mnemonics **pfam.p**, **pfsm.p**, **pfmam.p** and **pfmsm.p** are never used as such in the assembly language; these mnemonics are used here to designate classes of related instructions. Each value of DPC has a unique mnemonic associated with it.

**2.7 Addressing Modes**

Data access is limited to load and store instructions. Memory addresses are computed from two fields of load and store instructions: *src1* and *src2*.

1. *isrc1* either contains the identifier of a 32-bit integer register or contains an immediate 16-bit address offset.
2. *isrc2* always specifies a register.

Table 2.8 Types of Traps

| Type                     | Indication       |                                  | Caused by  |  |
|--------------------------|------------------|----------------------------------|--|--|
|                          | PSR,ESPR         | FSR                              | Condition  | Instruction  |
| Instruction Fault        | IT               | OF<br>IL                         | Software traps<br>Missing <b>unlock</b>  | <b>trap, intovr</b><br>Any   |
| Floating Point Fault     | FT               | SE<br>AO, MO<br>AU, MU<br>AI, MI | Floating-point source exception<br>Floating-point result exception<br>overflow<br>underflow<br>inexact result              | Any M- or A-unit except <b>fmLOW</b><br>Any M- or A-unit except <b>fmLOW, pfGT,</b><br>and <b>pfEQ</b> . Reported on any F-P<br>instruction plus <b>pst, fst</b> and<br>sometimes <b>fld, pfld, ixfr</b> |
| Instruction Access Fault | IAT              |                                  | Address translation exception<br>during instruction fetch  | Any  |
| Data Access Fault        | DAT*             |                                  | Load/store address translation<br>exception<br>Misaligned operand address<br>Operand address matches<br><b>db</b> register | Any load/store<br>Any load/store<br>Any load/store   |
| Interrupt                | IN               |                                  | External interrupt   |  |
| Reset                    | No trap bits set |                                  | Hardware RESET signal  |  |

**NOTES:** \*These cases can be distinguished by examining the operand addresses.  
The IL bit of the **psr** must be checked by the trap handler to tell if the bus is currently in a locked sequence.

Because either *isrc1* or *isrc2* may be null (zero), a variety of useful addressing modes result:

- offset + register* Useful for accessing fields within a record, where *register* points to the beginning of the record. Useful for accessing items in a stack frame, where *register* is *r3*, the register used for pointing to the beginning of the stack frame.
- register + register* Useful for two-dimensional arrays or for array access within the stack frame.
- register* Useful as the end result of any arbitrary address calculation.
- offset* Absolute address into the first or last 32K of the logical address space.

In addition, the floating-point load and store instructions may select autoincrement addressing. In this mode *isrc2* is replaced by the sum of *isrc1* and *isrc2* after performing the load or store. This mode makes stepping through arrays more efficient, because it eliminates an address-calculation instruction.

## 2.8 Traps and Interrupts

Traps are caused by exceptional conditions detected in programs or by external interrupts. Traps

cause interruption of normal program flow to execute a special program known as a trap handler. Traps are divided into the types shown in Table 2.8. Interrupts and traps start execution in single instruction mode at virtual address 0xFFFFF00 in supervisor level (U = 0).

### 2.8.1 TRAP HANDLER INVOCATION

This section applies to traps other than reset. When a trap occurs, execution of the current instruction is aborted. The instruction is restartable. The processor takes the following steps while transferring control to the trap handler:

1. Copies U (user mode) of the **psr** into PU (previous U).
2. Copies IM (interrupt mode) into PIM (previous IM).
3. Sets U to zero (supervisor mode).
4. Sets IM to zero (interrupts disabled).
5. If the processor is in dual instruction mode, it sets DIM; otherwise it clears DIM.
6. If the processor is in single-instruction mode and the next instruction will be executed in dual-instruction mode or if the processor is in dual-instruction mode and the next instruction will be executed in single-instruction mode, DS is set; otherwise, it is cleared.



7. The appropriate trap type bits in **psr** are set (IT, IN, IAT, DAT, FT). Several bits may be set if the corresponding trap conditions occur simultaneously.
8. An address is placed in the fault instruction register (**fir**) to help locate the trapped instruction. In single-instruction mode, the address in **fir** is the address of the trapped instruction itself. In dual-instruction mode, the address in **fir** is that of the floating-point half of the dual instruction. If an instruction or data access fault occurred, the associated core instruction is the high-order half of the dual instruction (**fir** + 4). In dual-instruction mode, when a data access fault occurs in the absence of other trap conditions, the floating-point half of the dual instruction will already have been executed.

The processor begins executing the trap handler by transferring execution to virtual address 0xFFFFF00. The trap handler begins execution in single-instruction mode. The trap handler must examine the trap-type bits in **psr** (IT, IN, IAT, DAT, FT) to determine the cause or causes of the trap.

### 2.8.2 INSTRUCTION FAULT

This fault is caused by any of the following conditions. In all cases the processor sets the Instruction Trap (IT) bit before entering the trap handler.

1. By the **trap** instruction. When **trap** is executed in dual-instruction mode, the floating-point companion of the **trap** instruction is not executed before the trap is taken.
2. By the **intovr** instruction. The trap occurs only if the Overflow Flag (OF) in **epsr** is set when **intovr** is executed. The trap handler should clear OF before returning. When **intovr** causes a trap in dual-instruction mode, the floating-point companion of the **intovr** instruction is completely executed before the trap is taken.
3. By violation of lock/unlock protocol, explained below. (Note that **trap** and **intovr** should not be used within a locked sequence; otherwise, it would be difficult to distinguish between this and the prior cases.)

The lock protocol requires the following sequence of activities:

1. **lock**
2. Any load or store instruction that misses the cache.
3. **unlock**
4. Any load or store instruction (regardless of whether it misses the cache)

There may be other instructions between any of these steps. The bus is locked after step 2, and re-

mains locked until step 4. Step 4 must follow step 1 by 30 instructions or less, otherwise the instruction trap occurs. In case of a trap, the Interlock (IL) bit is also set. If the load or store instruction in step 2 hits the cache, the sequence is legal, but the bus is not locked.

### 2.8.3 FLOATING-POINT FAULT

The floating-point fault can occur on floating-point instructions, **pst**, **fst**, and sometimes **fld**, **pfld**, **ixfr**. The floating-point faults of the Military i860 XR microprocessor support the floating-point exceptions defined by the IEEE standard as well as some other useful classes of exceptions. The Military i860 XR microprocessor divides these into two classes: source exceptions and result exceptions. The numerics library supplied by Intel adheres to the IEEE standard default handling for all these exceptions

#### 2.8.3.1 Source Exception Faults

When used as inputs to the multiplier or adder, all exceptional operands, including infinities, denormalized numbers and NaNs, cause a floating-point fault and set the Source Exception (SE) bit in the **fsr**. Source exceptions are reported on the instruction that initiates the operation. For pipelined operations, the pipeline is not advanced.

The SE value is undefined for faults on **fld**, **pfld**, **fst**, **pst** and **ixfr** instructions when in single-instruction mode or when in dual-instruction mode and the companion instruction is not a multiplier or adder operation.

#### 2.8.3.2 Result Exception Faults

The class of result exceptions includes any of the following conditions:

- **Overflow.** The absolute value of the rounded true result would exceed the largest positive finite number in the destination format.
- **Underflow** (when FZ is clear). The absolute value of the rounded true result would be smaller than the smallest positive finite number in the destination format.
- **Inexact result** (when TI is set). The result is not exactly representable in the destination format. For example, the fraction  $\frac{1}{3}$  cannot be precisely represented in binary form. This exception occurs frequently and indicates that some (generally acceptable) accuracy has been lost.

The point at which a result exception is reported depends upon whether pipelined operations are being used:

- **Scalar (nonpipelined) operations.** Result exceptions are reported on the next floating-point, **fst.x**, or **pst.x** (and sometimes **fld**, **pfld**, **ixfr**) instruction after the scalar operation. When a trap occurs, the last stage of the affected unit contains the result of the scalar operation.
- **Pipelined operations.** Result exceptions are reported when the result is in the last stage and the next floating-point, **fst.x** or **pst.x** (and sometimes **fld**, **pfld**, **ixfr**) instruction is executed. When a trap occurs, the pipeline is not advanced, and the last stage results (that caused the trap) remain unchanged.

When no trap occurs (either because FTE is clear or because no exception occurred), the pipeline is advanced normally by the new floating-point operation. The result-status bits of the affected unit are undefined until the point that result exceptions are reported. At this point, the last stage result-status bits (bits 29..22 and 16..9 of the **fsr**) reflect the values in the last stages of both the adder and multiplier. For example, if the last stage result in the multiplier has overflowed and a pipelined floating-point **pfadd** is started, a trap occurs and **MO** is set.

For scalar operations, the Result Register (RR) field of **fsr** specify the register in which the result was stored. RR is updated when the scalar instruction is initiated. The trap, however, occurs on a subsequent instruction. Programmers must prevent intervening stores to **fsr** from modifying the RR bits. Prevention may take one of the following forms:

- Before any store to **fsr** when a result exception may be pending, execute a dummy floating-point operation to trigger the result-exception trap.
- Always read from **fsr** before storing to it, and mask updates so that the RR field is not changed.

For pipelined operations, RR is cleared and the result is in the last stage of the pipeline of the appropriate unit. The trap handler must flush the pipeline, saving the results and the status bits.

In either pipelined or scalar mode, the trap handler must then compute the trapping result. In either case, the result has the same fraction as the true result and has an exponent which is the low-order bits of the true result. The trap handler can inspect the result, compute the result appropriate for that instruction (a NaN or an infinity, for example), and store the correct result. The result is either stored in the register specified by RR (if nonzero) or (if RR = 0) the trap handler must reload the pipeline with the saved results and status bits. The trap handler must clear the result status for the last stage and then reexecute the trapping instruction.

Result exceptions may be simultaneously reported for both the adder and multiplier units. In this case, the trap handler must correct the last stage of both pipelines.

#### 2.8.4 INSTRUCTION ACCESS FAULT

The Instruction Access Trap (IAT) occurs during address translation for instruction fetches in any of these cases:

- The address fetched is in a page whose P (present) bit in the page table is clear (not present).
- The address fetched is in a supervisor mode page, but the processor is in user mode.
- The address fetched is in a page whose PTE has A = 0, and the access occurs during a locked sequence (i.e., between **lock** and **unlock**).

Note that several instructions are fetched at one time, either due to instruction prefetching or to instruction caching. Therefore, a trap handler can change from supervisor to user mode and continue to execute instructions fetched from a supervisor page. An instruction access trap occurs only when the next group of instructions is fetched from a supervisor page (up to eight instructions later). If, in the meantime, the handler branches to a user page, no instruction access trap occurs. No protection violation results, because the processor does not permit data accesses to supervisor pages while running in user mode.

#### 2.8.5 DATA ACCESS FAULT

The Data Access Trap (DAT) results from an abnormal condition detected during a data operand fetch or store. Such an exception can be caused by only one of the following situations.

- An attempt is being made to write to a page whose (Dirty) D bit is clear.
- A memory operand is misaligned (is not located at an address that is a multiple of the length of the data).
- The address stored in the **db** register is equal to one of the addresses spanned by the operand.
- The operand is in a not-present page.
- An attempt is being made from user level to write to a read-only page or to access a supervisor-level page.
- The operand was in a page whose PTE had A = 0, and the access occurred during a locked sequence. (i.e., between **lock** and **unlock**.)
- Write protection (determined by **epsr** bit WP = 1) is violated in supervisor mode.





**2.8.6 INTERRUPT TRAP**

An interrupt is an event that is signaled from an external source. If the processor is executing with interrupts enabled (IM set in the **psr**), the processor sets the interrupt bit IN in the **psr**, and generates an interrupt trap. Vectored interrupts are implemented by interrupt controllers and software.

**2.8.7 RESET TRAP**

When the Military i860 XR microprocessor is reset, execution begins in single-instruction mode at physical address 0xFFFFF00. This is the same address as other traps. The reset trap can be distinguished from other traps by the fact that no trap bits are set. The instruction cache is flushed. The bits DPS, BL and ATE in **dirbase** are cleared. The Code-Size8 (CS8) mode is initialized if the INT/CS8 pin is asserted at the end of reset. The read-only fields of the **espr** are set to identify the processor, while the IL, WP and PBM bits are cleared. The bits U, IM, BR and BW in **psr** are cleared as are the trap bits FT, DAT, IAT, IN and IT. All other bits of **psr** and all other register contents are **undefined**.

Refer to Table 2.9 for a summary of these initial settings.

**Table 2.9 Register and Cache Values after Reset**

| Registers                | Initial Value  |
|--------------------------|--|
| Integer Registers        | <i>Undefined</i>   |
| Floating-Point Registers | <i>Undefined</i>   |
| <b>psr</b>               | U, IM, BR, BW, FT, DAT, IAT, IN, IT = 0; others are <i>undefined</i>                                 |
| <b>espr</b>              | IL, WP, PBM, BE = 0; Processor Type, Stepping Number, DCS are read only; others are <i>undefined</i> |
| <b>db</b>                | <i>Undefined</i>   |
| <b>dirbase</b>           | DPS, BL, ATE = 0; others are <i>undefined</i>  |
| <b>fir</b>               | <i>Undefined</i>   |
| <b>fsr</b>               | <i>Undefined</i>   |
| KR, KI, T, MERGE         | <i>Undefined</i>   |
| Caches                   | Initial Value  |
| Instruction Cache        | Flushed  |
| Data Cache               | <i>Undefined</i>   |
| TLB                      | Flushed  |

The software must ensure that the data cache is flushed and control registers are properly initialized before performing operations that depend on the

values of the cache or registers. The data cache has no "validity" bits, so memory accesses before the flush may result in false data cache hits.

Reset code must initialize the floating-point pipeline state to zero with floating-point traps disabled to ensure that no spurious floating-point traps are generated.

After a RESET the Military i860 XR microprocessor starts execution at supervisor level (U=0). Before branching to the first user-level instruction, the RESET trap handler or subsequent initialization code has to set PU and a trap bit so that an indirect branch instruction will copy PU to U, thereby changing to user level.

**2.9 Debugging**

The Military i860 XR microprocessor supports debugging with both data and instruction breakpoints. The features of the Military i860 architecture that support debugging include:

- **db** (data breakpoint register) which permits specification of a data addresses that the Military i860 XR microprocessor will monitor.
- BR (break read) and BW (break write) bits of the **psr**, which enable trapping of either reads or writes (respectively) to the address in **db**.
- DAT (data access trap) bit of the **psr**, which allows the trap handler to determine when a data breakpoint was the cause of the trap.
- **trap** instruction that can be used to set breakpoints in code. Any number of code breakpoints can be set. The values of the *src1* and *src2* fields help identify which breakpoint has occurred.
- IT (instruction trap) bit of the **psr**, which allows the trap handler to determine when a **trap** instruction was the cause of the trap.

**3.0 HARDWARE INTERFACE**

In the following description of the military i860's hardware interface, the  $\overline{\hspace{1em}}$  symbol (overbar) above a signal name indicates that the active or asserted state occurs when the signal is at a low voltage. When no  $\overline{\hspace{1em}}$  is present above the signal name, the signal is asserted when at the high voltage level.

**3.1 Signal Description**

Table 3.1 identifies functional groupings of the pins, lists every pin by its identifier, gives a brief description of its function, and lists some of its characteristics. All output pins are 3-state, except HLDA and





BREQ. All inputs are synchronous with the Clock (CLK), except HOLD and INT.

3.1.1 CLOCK (CLK)

The CLK input determines execution rate and timing of the Military i860 XR microprocessor. Timing of other signals is specified relative to the rising edge of this signal. The internal operating frequency is the same as the external clock. This signal is TTL compatible.

3.1.2 SYSTEM RESET (RESET)

Asserting RESET for at least 16 CLK periods causes initialization of the Military i860 XR microprocessor. Refer to section 3.2 "Initialization" for more details related to RESET.

3.1.3 BUS HOLD (HOLD) AND BUS HOLD ACKNOWLEDGE (HLDA)

These pins are used for Military i860 XR microprocessor bus arbitration. At some clock after the HOLD signal is asserted, the Military i860 XR microprocessor releases control of the local bus and puts all bus interface outputs (except BREQ and HLDA) into a floating state, then asserts HLDA—all during the same clock period. It maintains this state until HOLD is deasserted. Instruction execution stops only if required instructions or data cannot be read from the on-chip instruction and data caches.

The time required to acknowledge a hold request is one clock plus the number of clocks needed to finish any outstanding bus cycles. HOLD is recognized even while RESET or LOCK are asserted.

When leaving a bus hold, the Military i860 XR microprocessor deactivates HLDA and, in the same clock period, initiates a pending bus cycle, if any.

Hold is an asynchronous input.

3.1.4 BUS REQUEST (BREQ)

This signal is asserted when the i860 XR microprocessor has a pending memory request, even when HLDA is asserted. This allows an external bus arbiter to implement an "on demand only" policy for granting the bus to the i860 XR microprocessor. BREQ is asserted the clock after the i860 XR microprocessor realizes an internal request for the bus. In normal operation, BREQ goes low the clock after ADS goes low for the final pending bus cycle. (Refer to Figure 4.10 for timing information.) During data or instruction cache fills, however, BREQ may be deasserted for one or more clocks, due to cache and TLB logic.

3.1.5 INTERRUPT/CODE-SIZE (INT/CS8)

This dual purpose pin signifies either an external interrupt or Code-Size8 when asserted. If INT/CS8 is asserted during the clock before the falling edge of RESET, the eight-bit code-size mode is selected. For more about this mode, refer to Section 3.2 "Initialization".

At any other time it signifies an interruption of the current instruction stream. If interrupts are enabled (IM set in psr) when INT/CS8 is asserted, the Military i860 XR microprocessor fetches the next instruction from virtual address 0xFFFFF00. To assure that an interrupt is recognized, the INT/CS8 pin should remain asserted until the software acknowledges the interrupt (by writing, for example, to a memory-mapped port of an interrupt controller).

When the bus is not locked, the maximum time between the assertion of the INT/CS8 pin and the execution of the first instruction of the trap handler is ten clocks, plus the time for four sets of four pipelined read cycles and two sets of four pipelined writes (instruction- and data-cache misses and write-back cycles to update memory), plus the time for twenty nonpipelined read cycles (six TLB misses, with eight refetches when the A-bit is zero), plus the time for eight non-pipelined writes (updates to the A-bit).

If the bus is locked from a lock instruction, the pin is ignored and the INT bit of epsr is always zero. The lock instruction can only assert LOCK for 30-33 instructions before trapping.

INT/CS8 is an asynchronous input.



PRELIMINARY

Table 3.1 Pin Summary

| Pin Name                                 | Function                  | Active State | Input/Output |
|--|---------------------------|--------------|--------------|
| <b>Execution Control Pins</b>            |                           |              |              |
| CLK                                      | Clock                     |              | I            |
| RESET                                    | System reset              | High         | I            |
| HOLD                                     | Bus hold                  | High         | I            |
| HLDA                                     | Bus hold acknowledge      | High         | O            |
| BREQ                                     | Bus request               | High         | O            |
| INT/CS8                                  | Interrupt, code-size      | High         | I            |
| <b>Bus Interface Pins</b>                |                           |              |              |
| A31–A3                                   | Address bus               | High         | O            |
| $\overline{BE7}$ – $\overline{BE0}$      | Byte Enables              | Low          | O            |
| D63–D0                                   | Data bus                  | High         | I/O          |
| $\overline{LOCK}$                        | Bus lock                  | Low          | O            |
| $\overline{W/\overline{R}}$              | Write/Read bus cycle      | Hi/Low       | O            |
| $\overline{NEN}$                         | Next Near                 | Low          | O            |
| $\overline{NA}$                          | Next Address request      | Low          | I            |
| $\overline{READY}$                       | Transfer Acknowledge      | Low          | I            |
| $\overline{ADS}$                         | Address Status            | Low          | O            |
| <b>Cache Interface Pins</b>              |                           |              |              |
| $\overline{KEN}$                         | Cache Enable              | Low          | I            |
| PTB                                      | Page Table Bit            | High         | O            |
| <b>Testability Pins</b>                  |                           |              |              |
| SHI                                      | Boundary Scan Shift Input | High         | I            |
| BSCN                                     | Boundary Scan Enable      | High         | I            |
| SCAN                                     | Shift Scan Path           | High         | I            |
| <b>Intel-Reserved Configuration Pins</b> |                           |              |              |
| CC1–CC0                                  | Configuration             | High         | I            |
| <b>Power and Ground Pins</b>             |                           |              |              |
| VCC                                      | System power              |              |              |
| VSS                                      | System ground             |              |              |

A  $\overline{\hspace{1em}}$  above a pin name indicates that the signal is active when at the low voltage level.

### 3.1.6 ADDRESS PINS (A31–A3) AND BYTE ENABLES ( $\overline{BE7}$ – $\overline{BE0}$ )

The 29-bit address bus (A31–A3) identifies addresses to a 64-bit location. Separate byte-enable signals ( $\overline{BE7}$ – $\overline{BE0}$ ) identify which bytes are accessed within the 64-bit location. In all noncacheable read cycles ( $\overline{KEN}$  deasserted), the byte enables match the length and address of the requested data. Cacheable read cycles ( $\overline{KEN}$  asserted), however, result in four 64-bit memory cycles to fill an entire 32-byte cache line. The  $\overline{BE7}$  pins activated are those that represent the operand of the load instruction that caused the line fill, and these same  $\overline{BE7}$  pins remain

activated for all four cycles of the line fill. All 64 bits must be returned for each cycle without regard for the  $\overline{BE7}$  signals. In all write cycles (noncacheable writes as well as cache line write-backs) the  $\overline{BE7}$  signals indicate the bytes that must be written.

Instruction fetches ( $\overline{W/\overline{R}}$  is low) are distinguished from data accesses by the unique combinations of  $\overline{BE7}$ – $\overline{BE0}$  defined in Table 3.2. For an eight-bit code fetch in code-size8 (CS8) mode,  $\overline{BE2}$ – $\overline{BE0}$  are redefined to be A2–A0 of the address. In this case  $\overline{BE7}$ – $\overline{BE3}$  form the code shown in Table 3.2 that identifies an instruction fetch. The A2 in the table does not represent a physical pin, just a conceptual internal



address line value. The "x" under A2 for CS8 mode means "not applicable", or "don't care". All other combinations of byte enables indicate data accesses.

The address and byte-enable pins are driven until either NA or READY is asserted.

3.1.7 DATA PINS (D63-D0)

The bus interface has 64 bidirectional data pins (D63-D0) to transfer data in eight- to 64-bit quantities. Pins D7-D0 transfer the least significant byte; pins D63-D56 transfer the most significant byte.

In write bus cycles, the point at which data is driven onto the bus depends on the type of the preceding cycle. If there was no preceding cycle (i.e. the bus was idle), data is driven with the address. If the preceding cycle was a write, data is driven as soon as READY is returned from the previous cycle. If the preceding cycle was a read, data is driven one clock after READY is returned from the previous cycle, thereby allowing time for the bus to be turned around.

3.1.8 BUS LOCK (LOCK)

This signal is used to provide atomic (indivisible) read-modify-write sequences in multiprocessor systems. A multiprocessor bus arbiter must permit only one processor a locked access to the address which is on the bus when LOCK first activates. The system must maintain the lock of that location until LOCK deactivates.

The Military i860 XR microprocessor coordinates the external LOCK signal with the software-controlled Bus Lock (BL) bit of the dirbase register. Programmers do not have to be concerned about the fact that bus activity is not always synchronous with instruction execution. LOCK is asserted with ADS for the address operand of the first load or store instruction executed after the BL bit is set by the lock instruction. Pending bus cycles are locked according to the value of the BL bit when the instruction was executed. Even if the BL bit is changed between the time that an instruction generates an internal bus request and the time that the cycle appears on the bus, the i860 XR microprocessor still asserts LOCK for that bus cycle.

If ADS is active when LOCK deactivates, then that request should complete before the hardware relinquishes the lock. If ADS is not active, the locking of the location can immediately end when LOCK deactivates. Of course the simplest arbitration hardware can just lock the entire bus against all other accesses during LOCK assertion.

When the BL bit is deasserted with the unlock instruction, LOCK is deasserted with the next load or store but after any pending bus cycles. Between locked sequences, at least one cycle of no LOCK is guaranteed by the behavior of the unlock instruction. LOCK deassertion may occur independently of ADS for the case of a trap or a cache hit after unlock.

The Military i860 XR microprocessor also asserts LOCK during TLB miss processing for updates of the accessed bit in page-table entries. The maximum time that LOCK can be asserted in this case is five clocks plus the time required to perform a read-modify-write sequence. Instruction fetches do not alter the LOCK pin.

Between lock and unlock instructions, the INT pin is ignored and the INT bit of epsr is zero when read by ldc epsr. The time that interrupts are disabled is limited by the lock protocol outlined in Section 2.8.2.

3.1.9 WRITE/READ BUS CYCLE (W/R)

This pin specifies whether a bus cycle is a write (HIGH) or read (LOW) cycle.

3.1.10 NEXT NEAR (NENE)

The NENE signal allows higher-speed reads and writes in the case of consecutive reads and writes that access static column or page-mode DRAMs. The Military i860 XR microprocessor asserts NENE when the current address is in the same DRAM page as the previous bus cycle. The Military i860 XR microprocessor determines the DRAM page size by inspecting the DPS field in the dirbase register. The page size can range from 2^9 to 2^16 64-bit words, supporting DRAM sizes from 256K x 1, 256K x 4, and up. NENE is never asserted on the next bus cycle after HLDA is deasserted.

3.1.11 NEXT ADDRESS REQUEST (NA)

The NA signal makes address pipelining possible. The system asserts NA to indicate that it is ready to accept the next address from the Military i860 XR microprocessor. NA may be asserted before the current cycle ends. (If the system does not implement pipelining, NA does not have to be activated.) The Military i860 XR microprocessor samples NA every clock, starting one clock after the prior activation of ADS. When NA is active, the Military i860 XR microprocessor is free to drive address and bus-cycle definition for the next pending bus cycle. The Military i860 XR microprocessor remembers that NA was asserted when no internal request is pending; therefore, NA can be deactivated after the next rising edge of the CLK signal. Up to three bus cycles can be outstanding simultaneously.



Table 3.2 Identifying Instruction Fetches

| Code Fetch       | A2 | $\overline{BE7}$ | $\overline{BE6}$ | $\overline{BE5}$ | $\overline{BE4}$ | $\overline{BE3}$ | $\overline{BE2}$       | $\overline{BE1}$ | $\overline{BE0}$ |
|------------------|----|------------------|------------------|------------------|------------------|------------------|------------------------|------------------|------------------|
| Normal (Non-CS8) | 0  | 1                | 1                | 1                | 1                | 1                | 0                      | 1                | 0                |
| Normal (Non-CS8) | 1  | 1                | 0                | 1                | 0                | 1                | 1                      | 1                | 1                |
| CS8 Mode         | x  | 1                | 0                | 1                | 0                | 1                | Low-order address bits |                  |                  |

### 3.1.12 TRANSFER ACKNOWLEDGE ( $\overline{READY}$ )

The system asserts the  $\overline{READY}$  signal during read cycles when valid data is on the data pins and during write cycles when the system has accepted data from the data pins.  $\overline{READY}$  must be asserted for at least one clock. Sampling of  $\overline{READY}$  begins in the clock after an  $\overline{ADS}$  or in the second clock after a prior  $\overline{READY}$ .

### 3.1.13 ADDRESS STATUS ( $\overline{ADS}$ )

The Military i860 XR microprocessor asserts  $\overline{ADS}$  during the first clock of each bus cycle to identify the clock period during which it begins to assert outputs on the address bus. This signal is held active for one clock.

### 3.1.14 CACHE ENABLE ( $\overline{KEN}$ )

The Military i860 XR microprocessor samples  $\overline{KEN}$  to determine whether the data being read for the current cache-miss cycle is to be cached. This pin is internally NORed with the CD and WT bits to control cacheability on a page by page basis (refer to Table 3.3).

If the address is one that is permitted to be in the cache,  $\overline{KEN}$  must be continuously asserted during the sampling period starting from the second rising clock edge after  $\overline{ADS}$  is asserted, through the clock  $\overline{NA}$  or  $\overline{READY}$  is asserted. The entire 64 bits of the data bus will be used for the read, regardless of the state of the byte-enable pins. Three additional 64-bit bus cycles will be generated to fill the rest of the 32-byte cache block.

If  $\overline{KEN}$  is found deasserted at any clock from the clock after  $\overline{ADS}$  through the clock of the first  $\overline{NA}$  or  $\overline{READY}$ , the data being read will not be cached and two scenarios can occur: 1) if the cycle is due to data-cache miss, no subsequent cache-fill cycles will be generated; 2) if the cycle is due to an instruction-cache miss, additional cycle(s) will be generated until the address reaches a 32-byte boundary. To avoid caching a line, external hardware must deassert  $\overline{KEN}$  during or before the first  $\overline{NA}$  or  $\overline{READY}$ .

Table 3.3 Cacheability Based on  $\overline{KEN}$  and CD or WT

| CD or WT | $\overline{KEN}$ | Meaning             |
|----------|------------------|---------------------|
| 0        | 0                | Cacheable access    |
| 0        | 1                | Noncacheable access |
| 1        | 0                | Noncacheable page   |
| 1        | 1                | Noncacheable page   |

### 3.1.15 PAGE TABLE BIT (PTB)

Depending on the setting of the PBM (page-table bit mode) bit of the *epsr*, the PTB reflects the value of either the CD (cache disable) bit or the WT (write through) bit of the page-table entry used for the current cycle. When paging is disabled, PTB remains inactive.

### 3.1.16 BOUNDARY SCAN SHIFT INPUT (SHI)

This pin is used with the testability features. Refer to section 3.3.

### 3.1.17 BOUNDARY SCAN ENABLE (BSCN)

This pin is used with the testability features. Refer to section 3.3.

### 3.1.18 SHIFT SCAN PATH (SCAN)

This pin is used with the testability features. Refer to section 3.3.

### 3.1.19 CONFIGURATION (CC1-CC0)

These two pins are reserved by Intel. Strap both pins LOW.

### 3.1.20 SYSTEM POWER ( $V_{CC}$ ) AND GROUND ( $V_{SS}$ )

The Military i860 XR microprocessor has 48 pins for power and ground. All pins must be connected to the appropriate low-inductance power and ground signals in the system.

### 3.2 Initialization

Initialization of the Military i860 XR microprocessor is caused by assertion of the RESET signal for at least 16 clocks. Table 3.4 shows the status of output pins during the time that RESET is asserted. Note that HOLD requests are honored during RESET and that the status of output pins depends on whether a HOLD request is being acknowledged.

**Table 3.4 Output Pin Status During Reset**

| Pin Name                        | Pin Value             |                   |
|---------------------------------|-----------------------|-------------------|
|                                 | HOLD Not Acknowledged | HOLD Acknowledged |
| ADS, LOCK                       | HIGH                  | HI-Z              |
| W/ $\bar{R}$ , PTB              | LOW                   | HI-Z              |
| BREQ                            | LOW                   | LOW               |
| HLDA                            | LOW                   | HIGH              |
| D63-D0                          | HI-Z                  | HI-Z              |
| A31-A3, BE7- $\bar{BE}0$ , NENE | Undefined             | HI-Z              |

After a reset, the Military i860 XR microprocessor begins executing at physical address 0xFFFFF00. The program-visible state of the Military i860 XR microprocessor after reset is detailed in section 2.8.7.

Eight-bit code-size mode is selected when INT/CS8 is asserted during the clock before the falling edge of RESET. While in eight-bit code-size mode, instruction cache misses are byte reads (transferred on D7-D0 of the data bus) instead of eight-byte reads. This allows the Military i860 XR microprocessor to be bootstrapped from an eight-bit EPROM. For these code reads, byte enables  $\bar{BE}2$ - $\bar{BE}0$  are redefined to be the low order three bits of the address, so that a complete byte address is available. These reads update the instruction cache if  $\bar{KEN}$  is asserted (refer to section 3.1.14) and are not pipelined even if  $\bar{NA}$  is asserted. While in this mode, instructions must reside in an eight-bit wide memory, while data must reside in a separate 64-bit wide

memory. After the code has been loaded into 64-bit memory, initialization code can initiate 64-bit code fetches by clearing the CS8 bit of the **dirbase** register (refer to section 2). Once eight-bit code-size mode is disabled by software, it cannot be reenabled except by resetting the Military i860 XR microprocessor.

### 3.3 Testability

The Military i860 XR microprocessor has a *boundary scan mode* that may be used in component- or board-level testing to test the signal traces leading to and from the Military i860 XR microprocessor. Boundary scan mode provides a simple serial interface that makes it possible to test all signal traces with only a few probes. Probes need be connected only to CLK, BSCN, SCAN, SHI, BREQ, RESET, and HOLD.

The pins BSCN and SCAN control the boundary scan mode (refer to Table 3.5). When BSCN is asserted, the Military i860 XR microprocessor enters boundary scan mode on the next rising clock edge. Boundary scan mode can be activated even while RESET is active. When BSCN is deasserted while in boundary scan mode, the Military i860 XR microprocessor leaves boundary scan mode on the next rising clock edge. After leaving boundary scan mode, the internal state is undefined; therefore, RESET should be asserted.

**Table 3.5 Test Mode Selection**

| BSCN | SCAN | Testability Mode                                       |
|------|------|--|
| LO   | LO   | No testability mode selected (Reserved for Intel)      |
| LO   | HI   | Boundary scan mode, normal                             |
| HI   | LO   | Boundary scan mode, normal                             |
| HI   | HI   | Boundary scan mode, shift SHI as input; BREQ as output |

For testing purposes, each signal pin has associated with it an internal latch. Table 3.6 identifies these latches by name and classifies them as input, output, or control. The input and output latches carry the name of the corresponding pins.



Table 3.6 Test Mode Latches

| Input Latch                                       | Output Latch  | Associated Control Latch  |
|---|---|---|
| SHI<br>BSCN<br>SCAN<br>RESET<br>D0-D63<br>CC1-CC0 | D0-D63  | DATA <sub>t</sub>   |
|   | A31-A3<br>NENE<br>PTB<br>W/R<br>ADS<br>HLDA<br>LOCK | ADDR <sub>t</sub><br>NENEt<br>PTB <sub>t</sub><br>W/R <sub>t</sub><br>ADSt<br>LOCK <sub>t</sub> |
| READY<br>KEN<br>NA<br>INT/CS8<br>HOLD             | BE7-BE0<br>BREQ                                     | BE <sub>t</sub>   |

Within boundary scan mode the Military i860 XR microprocessor operates in one of two submodes: normal mode or shift mode, depending on the value of the SCAN input. A typical test sequence is . . .

1. Enter shift mode to assign values to the latches that correspond with the pins.
2. Enter normal mode. In normal mode the Military i860 XR microprocessor transfers the latched values to the output pins and latches the values that are being driven onto the input pins.
3. Reenter shift mode to read the new values of the input pins.

### 3.3.1 NORMAL MODE

When SCAN is deasserted, with BSCN asserted the normal mode is selected. For each input pin (RESET, HOLD, INT/CS8, NA, READY, KEN, SHI, BSCN, SCAN, CC1 and CC0), the corresponding latch is loaded with the value that is being driven onto the pin.

The three-state output pins (A31-A3, BE7-BE0, W/R, NENE, ADS, LOCK and PTB) are enabled by the control latches ADDR<sub>t</sub> (for A31-A3), BE<sub>t</sub>, W/R<sub>t</sub>, NENEt, ADSt, LOCK<sub>t</sub> and PTB<sub>t</sub>. If a control latch is set, the corresponding output latches drive their output pins; otherwise the pins are not driven.

The I/O pins (D63-D0) are enabled by the control latch DATA<sub>t</sub>, which is similar to the other control latches. In addition, when DATA<sub>t</sub> is not set, the data pins are treated as input pins and their values are latched.

### 3.3.2 SHIFT MODE

When SCAN is asserted, with BSCN asserted the shift mode is selected. In shift mode, the pins are organized into a *boundary scan chain*. The scan chain is configured as a shift register that is shifted on the rising edge of CLK. The SHI pin is connected to the input of one end of the boundary scan chain. The value of the most significant bit of the scan chain is output on the BREQ pin. To avoid glitches while the values are being shifted along the chain, the tester should assert both the RESET and HOLD pins. Then all three-state outputs are disabled (placed in a HI-Z state). The order of the pins within the chain is shown in Figure 3.1.

A tester causes entry into this mode for one of two purposes:

1. To assign values to output latches to be driven onto output pins upon subsequent entry into normal mode.
2. To read the values of input pins previously latched in normal mode.

## 4.0 BUS OPERATION

A bus cycle begins when ADS is asserted and ends when READY is sampled active. READY is sampled one clock after assertion of ADS and thereafter until it becomes active. New cycles can start as often as every other clock until three cycles are outstanding. A bus cycle is considered outstanding as long as READY has not been asserted to terminate that cycle. After READY becomes active, it is not sampled again for the following (outstanding) cycle until the second clock after the one during which it became active. READY is assumed to be inactive when it is not sampled.

With regard to how a bus cycle is generated by the Military i860 XR microprocessor, there are two types of cycles: pipelined and nonpipelined. Both types of cycles can be either read or write cycles. A pipelined cycle is one that starts while one or two other bus cycles are outstanding. A nonpipelined cycle is one that starts when no other bus cycles are outstanding.

### 4.1 Pipelining

A *m-n* read or write cycle is a cycle with a total cycle time of *m* clocks and a cycle-to-cycle time of *n* clocks (*m* ≥ *n*). Total cycle time extends from the clock in which *ADS* is activated to the clock in which *READY* becomes active, whereas, cycle-to-cycle time extends from the time that *READY* is sampled active for the previous cycle to the time that it is sampled active again for the current cycle. When *m* = *n*, a nonpipelined cycle is implied; *m* > *n* implies a pipelined cycle.

Pipelining may occur for the next bus cycle any time the current bus cycle requires more than two clock periods to finish (*m* > 2). The next cycle can be initiated when *NA* (next address) is sampled active, even if the current cycle has not terminated. In this case, pipelining occurs. *NA* is not recognized until after *ADS* has become inactive.

To allow high transfer rates in large memory systems, two-level pipelining is supported (i.e., there may be up to three cycles in progress at one time). Pipelining enables a new word of data to be transferred every two clocks, even though the total cycle time may be up to six clocks.

### 4.2 Bus State Machine

The operation of the bus is described in terms of a bus state machine using a state transition diagram. Figure 4.1 illustrates the Military i860 XR microprocessor bus state machine. A bus cycle is composed of two or more states. Each bus state lasts for one CLK period.

The Military i860 XR microprocessor supports up to two levels of address pipelining. Once it has started the first bus cycle, it can generate up to two more cycles as long as *READY* remains inactive. To start a new bus cycle while other cycles are still outstanding, *NA* must be active for at least one clock cycle starting with the clock after the previous *ADS*. *NA* is latched internally.

States *T<sub>j</sub>* and *T<sub>jk</sub>*, for *j* = {1,2,3} and *k* = {1,2}, are used to describe the state of the Military i860 XR microprocessor Bus State Machine. Index *j* indicates the number of outstanding bus cycles while index *k* distinguishes the intermediate states for the *j*-th outstanding cycle.

Therefore there can be up to three outstanding cycles, and there are two possible intermediate states for each level of pipelining. *T<sub>11</sub>* is the next state after *T<sub>1</sub>*, as long as *j* cycles are outstanding. *T<sub>12</sub>* is entered when *NA* is active but the Military i860 XR microprocessor is not ready to start a new cycle.

Five conditions have to be met to start a new cycle while one or more cycles are already pending:

1. *READY* inactive
2. *NA* having been active
3. An internal request pending (*BREQ* active)
4. *HOLD* not active
5. Fewer than three cycles outstanding

Note that *BREQ* is asserted on the clock after the Military i860 XR microprocessor realizes an internal request for the bus.

Upon hardware *RESET*, the bus control logic enters the idle state *T<sub>1</sub>* and awaits an internal request for a bus cycle. If a bus cycle is requested while there is no hold request from the system, a bus cycle begins, advancing to state *T<sub>1</sub>*. On the next cycle, the state machine automatically advances to state *T<sub>11</sub>*. If *READY* is active in state *T<sub>11</sub>*, the bus control logic returns either to *T<sub>1</sub>*, if no new cycle is started, or to *T<sub>1</sub>*, if a new cycle request is pending internally. If an internal bus request is pending each time *READY* is active, the state machine continues to cycle between *T<sub>11</sub>* and *T<sub>1</sub>*.

However, if *READY* is not active but the next address request is pending (as indicated by an active *NA*), the state machine advances either to state *T<sub>2</sub>* (if an internal bus request is pending, signifying that two bus cycles are now outstanding), or to state *T<sub>12</sub>*

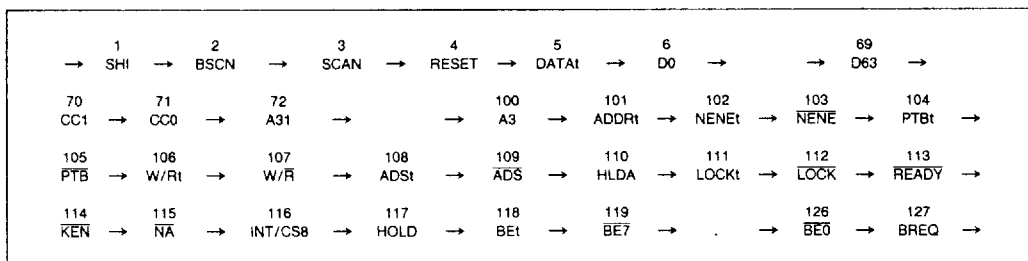

Figure 3.1 Order of Boundary Scan Chain



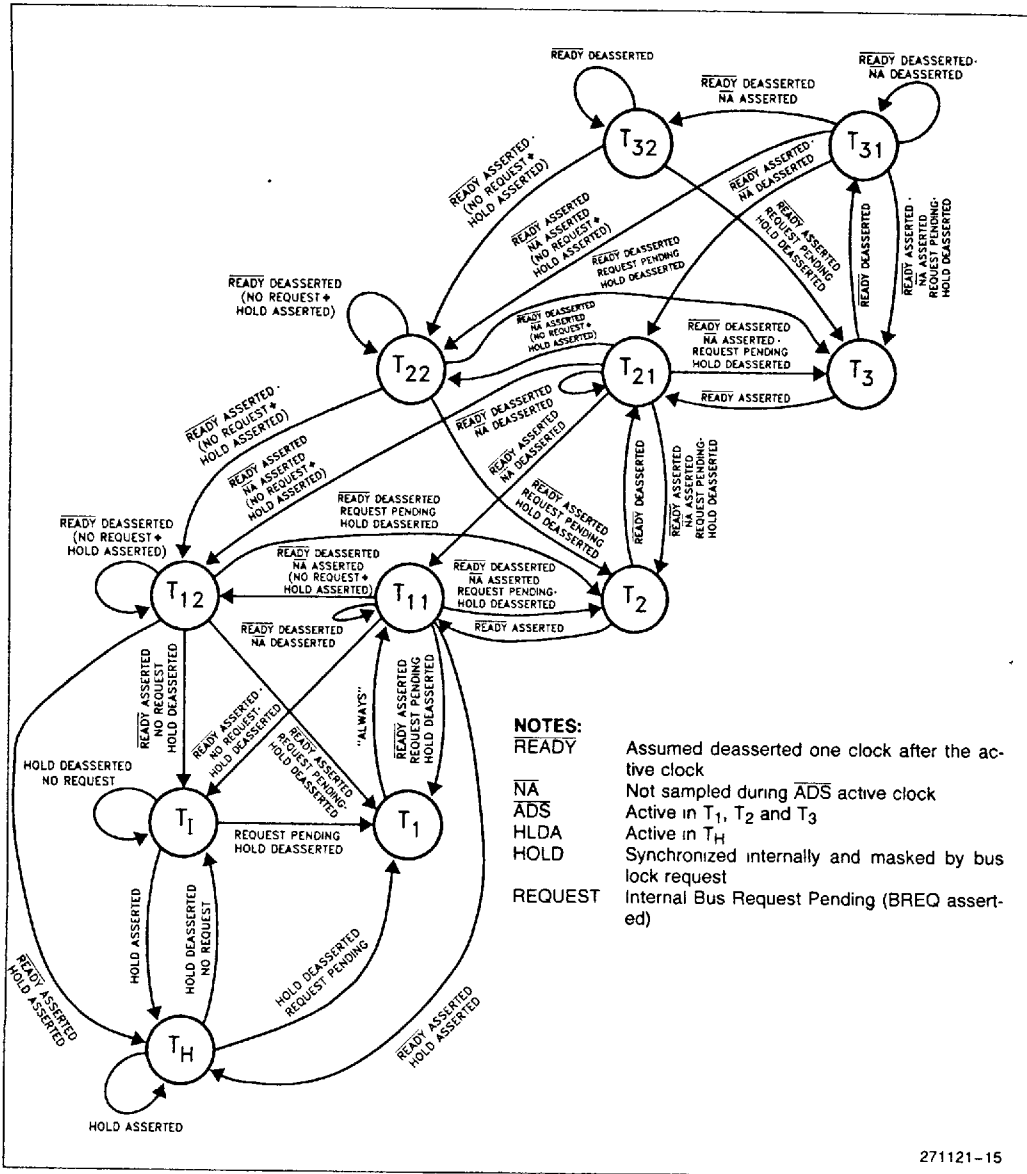

Figure 4.1 Bus State Machine

(if no bus internal request is pending, signifying  $\overline{NA}$  has been found active). Transitions from state  $T_{12}$  are similar to those from  $T_{11}$ .

If there are two outstanding bus cycles (as indicated by  $T_{2k}$  for  $k = \{1,2\}$ ) and  $\overline{NA}$  is latched active but  $\overline{READY}$  is not active, one more bus request causes entry into state  $T_3$ . Transitions from this state are similar to those from  $T_2$ .

In general, if there is an internal bus request each time both  $\overline{READY}$  and  $\overline{NA}$  are active, the state machine continues to oscillate between  $T_{j1}$  and  $T_j$ , for  $j = \{2,3\}$ .

When  $\overline{NA}$  is sampled active while there is a pending bus request,  $\overline{ADS}$  is activated in the next clock period (provided no more than two cycles are already outstanding).



Internal pending bus requests start new bus cycles only if no HOLD request has been recognized.  $T_H$  is entered from the idle state  $T_I$ ,  $T_{11}$  and  $T_{12}$ . HLDA is active in this state. There is a one clock delay to synchronize the HOLD input when the signal meets the respective minimum setup and hold time requirements. The state machine uses the synchronized HOLD to move from state to state.

4.3.1 NONPIPELINED READ CYCLES

A read cycle begins with the clock in which  $\overline{ADS}$  is asserted. The Military i860 XR microprocessor begins driving the address during this clock. It samples  $\overline{READY}$  for active state every clock after the first clock. A minimum of two clocks are required per cycle. Data is latched when  $\overline{READY}$  is found active when sampled at the end of a clock period. Figure 4.2 illustrates nonpipelined read cycles with zero wait states.

4.3 Bus Cycles

Figures 4.2 through 4.10 illustrate combinations of bus cycles.

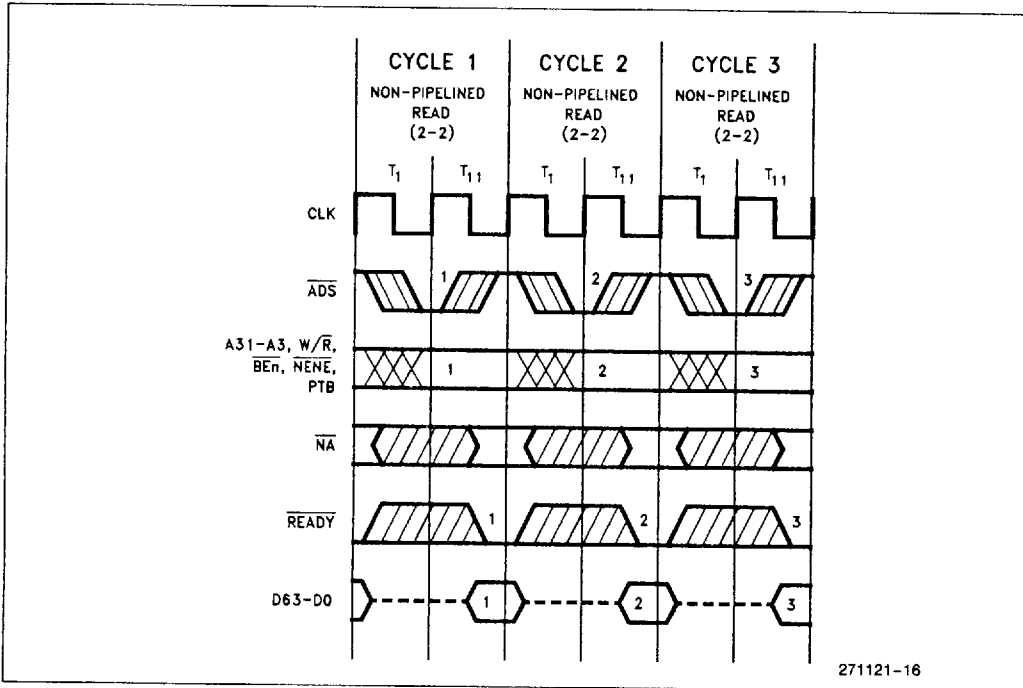

Figure 4.2 Fastest Read Cycles



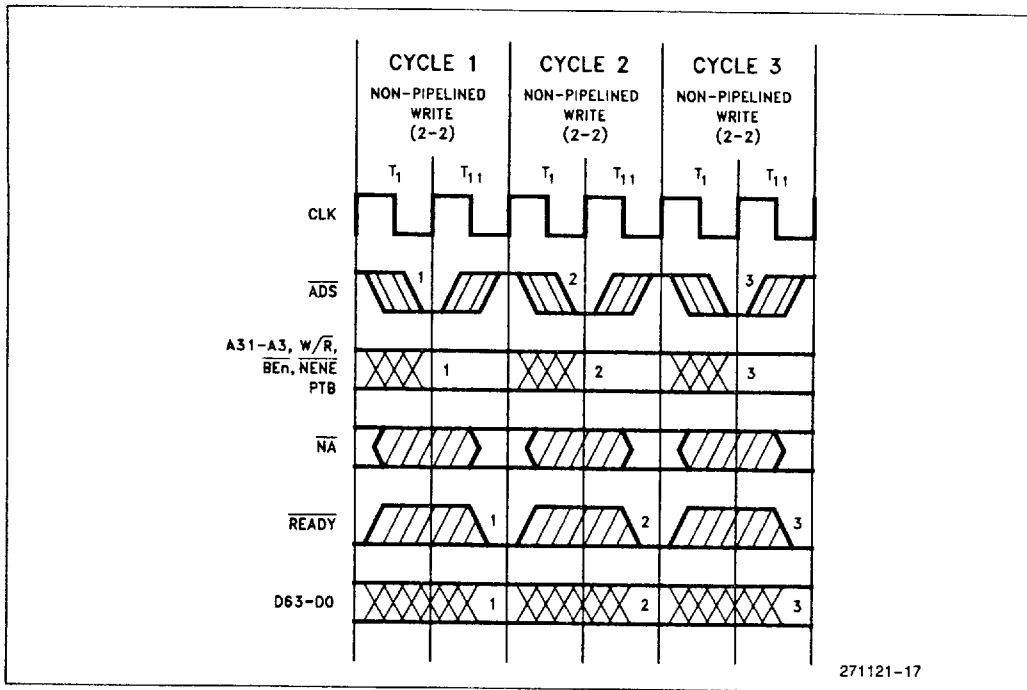

Figure 4.3 Fastest Write Cycles

**4.3.2 NONPIPELINED WRITE CYCLES**

The  $\overline{ADS}$  and  $\overline{READY}$  activity for write cycles follows the same logic as that for read cycles, as Figure 4.3 illustrates for back-to-back, nonpipelined write cycles with zero wait-states.

The fastest write cycle takes only two clocks to complete. However, when a read cycle immediately precedes a write cycle, the write cycle must contain a wait state, as illustrated in Figure 4.4. Because the

device being read might still be driving the data bus during the first clock of the write cycle, there is a potential for bus contention. To help avoid such contention, the Military i860 XR microprocessor does not drive the data bus until the second clock of the write cycle. The wait state is required to provide the additional time necessary to terminate the write cycle. In other read-write combinations, the Military i860 XR microprocessor does not require a wait state.

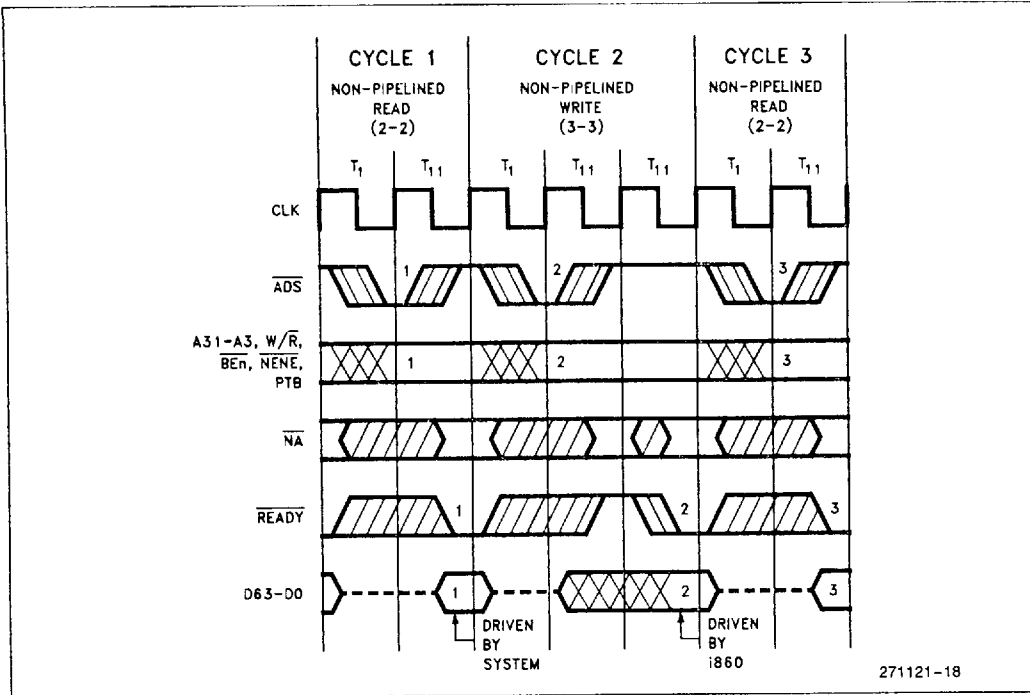

Figure 4.4 Fastest Read/Write Cycles

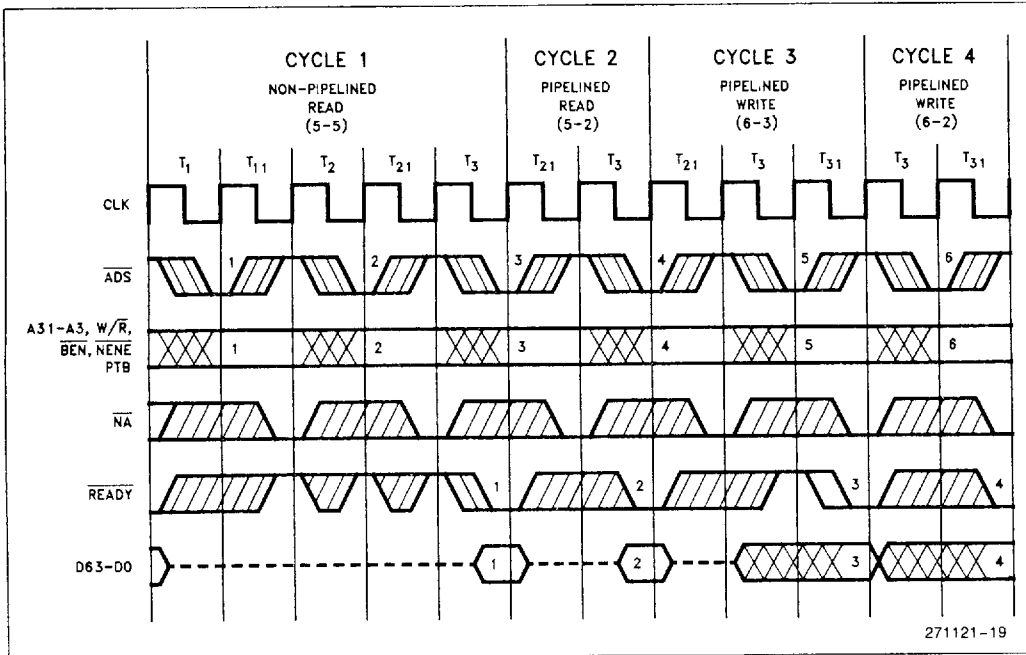

Figure 4.5 Pipelined Read Followed by Pipelined Write

PRELIMINARY

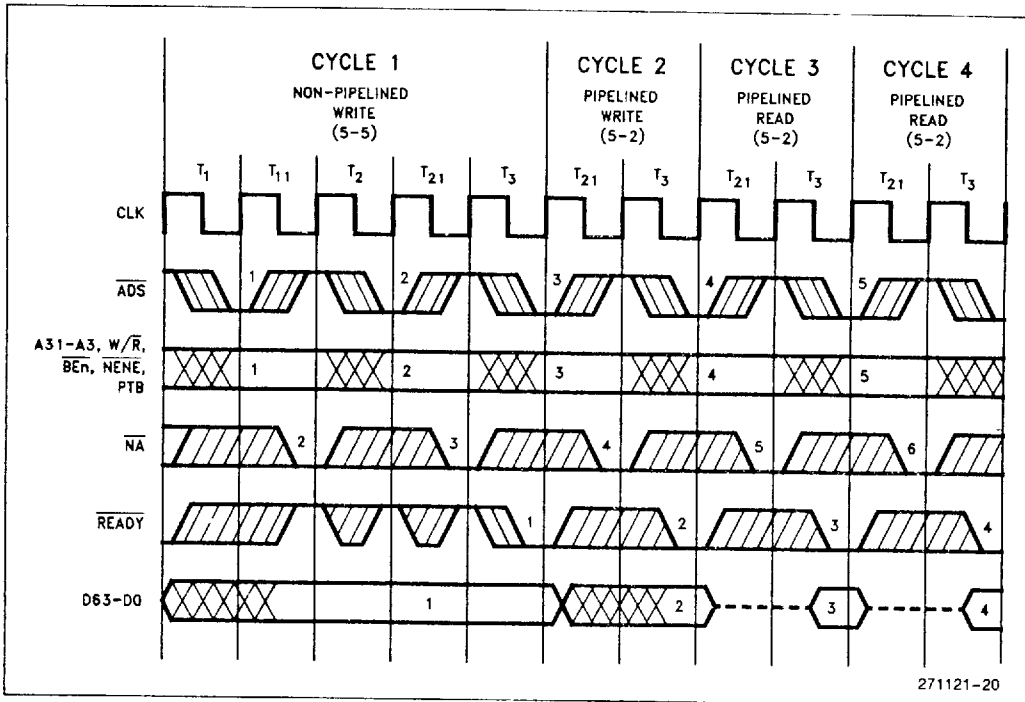

Figure 4.6 Pipelined Write Followed by Pipelined Read

4.3.3 PIPELINED READ AND WRITE CYCLES

Figures 4.5 and 4.6 illustrate combinations of non-pipelined and pipelined read and write cycles. The following description applies to both diagrams. While Cycle 1 is still in progress, two new cycles are initiated. By the time READY first becomes active, the state machine has moved through states T<sub>1</sub>, T<sub>11</sub>, T<sub>2</sub>, T<sub>21</sub> and T<sub>3</sub>. Cycles 3 and 4 show how activating READY terminates the corresponding outstanding cycle, and yet activating NA while there is an internal request pending adds a new outstanding cycle.

In Figure 4.5, Cycle 3 is a write cycle following a read cycle; therefore, one wait state must be inserted. The Military i860 XR microprocessor does not drive the data bus until one clock after the read data is returned from the preceding read cycle. During Cycles 3 and 4, the state machine oscillates between

states T<sub>3</sub> and T<sub>31</sub> maintaining full bus capacity (two levels of pipelining, three outstanding cycles) Cycles 2, 3 and 4 in Figure 4.6 are 5-2 cycles, i.e. each requires a total cycle time of five clocks while the throughput rate is one cycle every two clocks

Figure 4.7 illustrates in a more general manner how the NA signal controls pipelining. Cycle 1 is a 2-2 cycle, the fastest possible. The next cycle cannot be started any earlier; therefore, there is no need to activate NA to start the next cycle early. Cycle 2, a 3-3 read, is different. Cycle 3 can be started during the third state (a wait state) of Cycle 2, and NA is asserted to accomplish this.

NA is not activated following the ADS clock of Cycle 3, thereby allowing Cycle 3 to terminate before the start of Cycle 4. As a result, Cycle 4 is a nonpipelined cycle

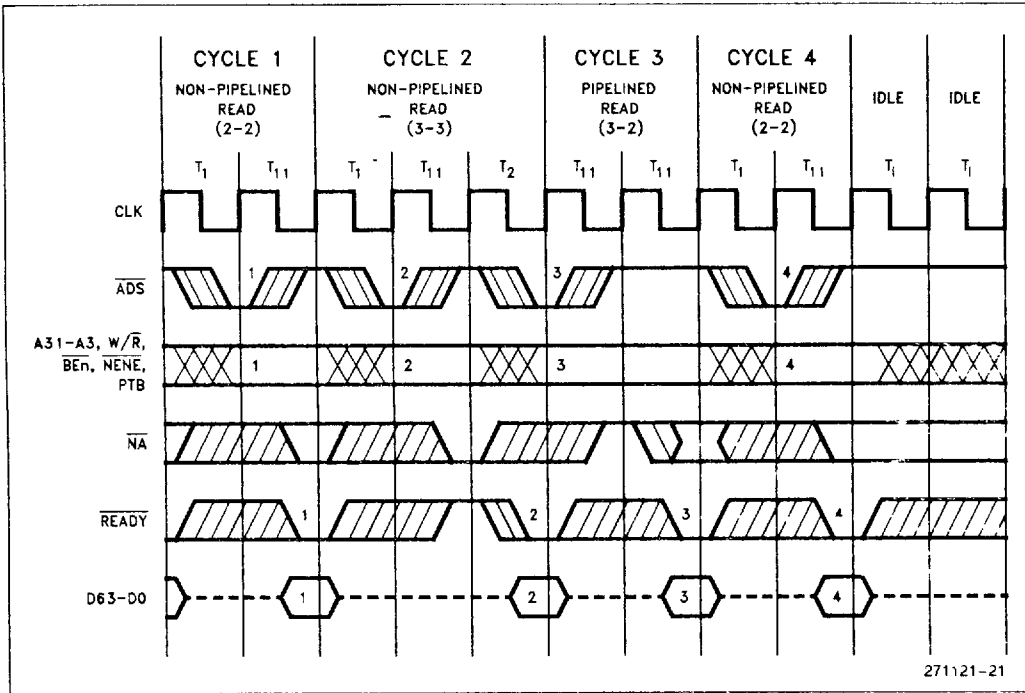

Figure 4.7 Pipelining Driven by NA

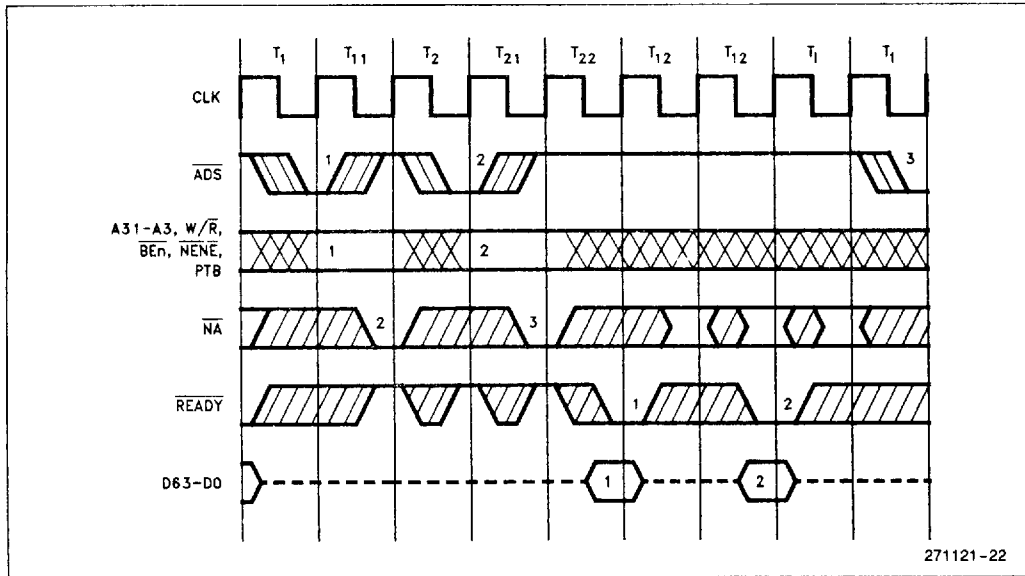

Figure 4.8  $\overline{NA}$  Active with No Internal Bus Request



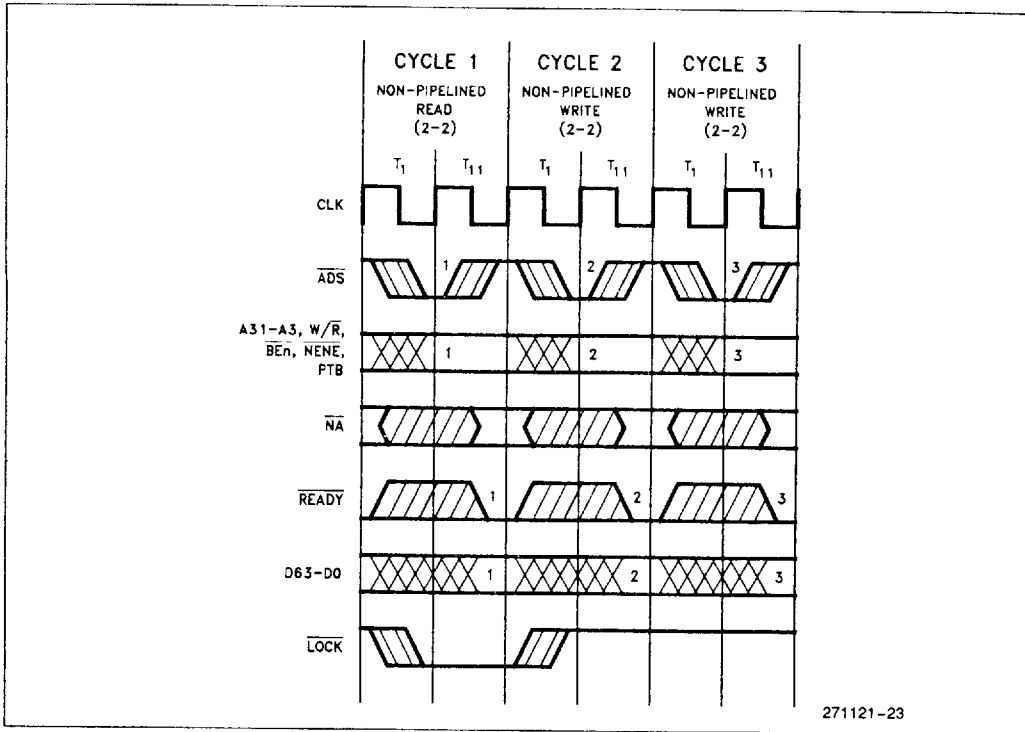

Figure 4.9 Locked Cycles

When there is no internal bus request, activating  $\overline{NA}$  does not start a new cycle; the Military i860 XR microprocessor, however, remembers that  $\overline{NA}$  has been activated. Figure 4.8 illustrates the situation where  $\overline{NA}$  is active but no internal bus request is pending.  $\overline{NA}$  is activated when two cycles are outstanding. Because there is no internal request pending until after one idle state, no new bus cycle is started during that period.

4.3.4 LOCKED CYCLES

The  $\overline{LOCK}$  signal is asserted when the current bus cycle is to be locked with the next bus cycle. Assertion of  $\overline{LOCK}$  may be initiated by a program's setting the BL bit of the **dirbase** register using the **lock** instruction (refer to Section 2) or by the Military i860 XR microprocessor itself during page table updates.

In Figure 4.9, the first read cycle is to be locked with the following write cycle. If there were idle states between the cycles, the  $\overline{LOCK}$  signal would remain asserted. This is the case for a read/modify/write operation. Cycle 3 is not locked because  $\overline{LOCK}$  is no longer asserted when Cycle 2 starts.

4.3.5 HOLD AND BREQ ARBITRATION CYCLES

The HOLD, HLDA, and BREQ signals permit bus arbitration between the Military i860 XR microprocessor and another bus master.

See Figure 4.10. When HOLD is asserted, the Military i860 XR microprocessor does not relinquish control of the bus until all outstanding cycles are completed. If HOLD were asserted one clock earlier, the last Military i860 XR microprocessor bus cycle before HLDA would not be started.

The outputs (except HLDA and BREQ) float when HLDA is asserted. HOLD is sampled at the end of the clock in which it is activated. Recommended set-up and hold times must be met to guarantee sampling one clock after external HOLD activation. When HOLD is sampled active, a one clock delay for internal synchronization follows. Likewise when HOLD is deasserted, there is a one-clock delay for internal synchronization before HLDA is deasserted.

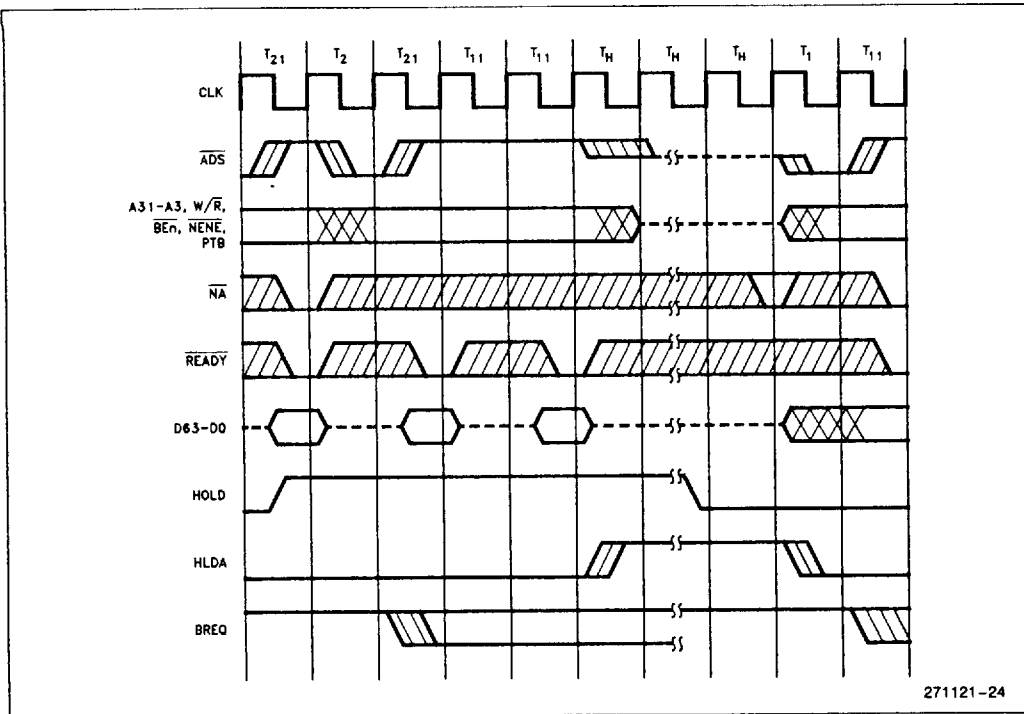

Figure 4.10 HOLD, HLDA and BREQ

If, during a HOLD cycle, an internal bus request is generated, BREQ is activated even though HLDA is asserted. It remains active at least until the clock after ADS is activated for the requested cycle.

RESET. If INT/CS8 is sampled active, the Military i860 XR microprocessor enters CS8 mode. No inputs (except for HOLD and INT/CS8) are sampled during RESET.

#### 4.4 Bus States During RESET

Figure 4.11 shows how INT/CS8 is sampled during the clock period just before the falling edge of

RESET. Note that, because HOLD is recognized even while RESET is active, the HLDA output signal may also become active during RESET. Refer to Table 3.4 "Output Pin Status During Reset".

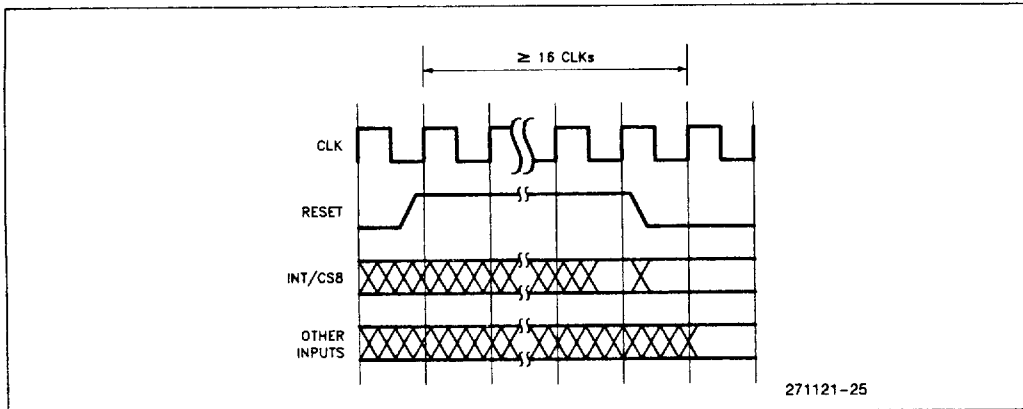

Figure 4.11 Reset Activities





5.0 MECHANICAL DATA

Figures 5.1, 5.2 and 5.3 show the locations of pins; Tables 5.1, 5.2, 5.3 and 5.4 help to locate pin identifiers.

|    | S                      | R                      | Q                      | P                      | N                      | M          | L          | K          | J          | H          | G          | F          | E                      | D                      | C                      | B                      | A                      |    |
|----|------------------------|------------------------|------------------------|------------------------|------------------------|------------|------------|------------|------------|------------|------------|------------|------------------------|------------------------|------------------------|------------------------|------------------------|----|
| 1  | ( )<br>V <sub>CC</sub> | ( )<br>V <sub>SS</sub> | ( )<br>V <sub>CC</sub> | ( )<br>V <sub>SS</sub> | ( )<br>A12             | ( )<br>A17 | ( )<br>A19 | ( )<br>A21 | ( )<br>A23 | ( )<br>A25 | ( )<br>A29 | ( )<br>A31 | ( )<br>V <sub>CC</sub> | ( )<br>V <sub>SS</sub> | ( )<br>V <sub>CC</sub> | ( )<br>V <sub>SS</sub> | ( )<br>V <sub>CC</sub> | 1  |
| 2  | ( )<br>V <sub>SS</sub> | ( )<br>V <sub>CC</sub> | ( )<br>V <sub>SS</sub> | ( )<br>A8              | ( )<br>A10             | ( )<br>A13 | ( )<br>A15 | ( )<br>A18 | ( )<br>A20 | ( )<br>A24 | ( )<br>A27 | ( )<br>A28 | ( )<br>CC0             | ( )<br>V <sub>CC</sub> | ( )<br>V <sub>SS</sub> | ( )<br>V <sub>CC</sub> | ( )<br>V <sub>SS</sub> | 2  |
| 3  | ( )<br>V <sub>CC</sub> | ( )<br>V <sub>SS</sub> | ( )<br>A6              | ( )<br>A7              | ( )<br>A9              | ( )<br>A11 | ( )<br>A14 | ( )<br>A16 | ( )<br>CLK | ( )<br>A22 | ( )<br>A26 | ( )<br>A30 | ( )<br>CC1             | ( )<br>D62             | ( )<br>D60             | ( )<br>V <sub>SS</sub> | ( )<br>V <sub>CC</sub> | 3  |
| 4  | ( )<br>V <sub>SS</sub> | ( )<br>V <sub>CC</sub> | ( )<br>A5              |                        |                        |            |            |            |            |            |            |            |                        | ( )<br>D63             | ( )<br>D59             | ( )<br>V <sub>SS</sub> | ( )<br>V <sub>CC</sub> | 4  |
| 5  | ( )<br>V <sub>CC</sub> | ( )<br>A4              | ( )<br>A3              |                        |                        |            |            |            |            |            |            |            |                        | ( )<br>D61             | ( )<br>D58             | ( )<br>D56             |                        | 5  |
| 6  | ( )<br>W/R             | ( )<br>NENE            | ( )<br>PTB             |                        |                        |            |            |            |            |            |            |            |                        | ( )<br>D57             | ( )<br>D54             | ( )<br>D52             |                        | 6  |
| 7  | ( )<br>ADS             | ( )<br>HLDA            | ( )<br>BREQ            |                        |                        |            |            |            |            |            |            |            |                        | ( )<br>D55             | ( )<br>D53             | ( )<br>D50             |                        | 7  |
| 8  | ( )<br>LOCK            | ( )<br>KEN             | ( )<br>READY           |                        |                        |            |            |            |            |            |            |            |                        | ( )<br>D51             | ( )<br>D49             | ( )<br>D48             |                        | 8  |
| 9  | ( )<br>INT/CS8         | ( )<br>NA              | ( )<br>HOLD            |                        |                        |            |            |            |            |            |            |            |                        | ( )<br>D47             | ( )<br>D45             | ( )<br>D46             |                        | 9  |
| 10 | ( )<br>BE5             | ( )<br>BE7             | ( )<br>BE6             |                        |                        |            |            |            |            |            |            |            |                        | ( )<br>D43             | ( )<br>D42             | ( )<br>D44             |                        | 10 |
| 11 | ( )<br>BE3             | ( )<br>BE2             | ( )<br>BE4             |                        |                        |            |            |            |            |            |            |            |                        | ( )<br>D39             | ( )<br>D41             | ( )<br>D40             |                        | 11 |
| 12 | ( )<br>SHI             | ( )<br>BE1             | ( )<br>BE0             |                        |                        |            |            |            |            |            |            |            |                        | ( )<br>D37             | ( )<br>D36             | ( )<br>D38             |                        | 12 |
| 13 | ( )<br>RESET           | ( )<br>SCAN            | ( )<br>BSCN            |                        |                        |            |            |            |            |            |            |            |                        | ( )<br>D35             | ( )<br>D34             | ( )<br>V <sub>CC</sub> |                        | 13 |
| 14 | ( )<br>V <sub>SS</sub> | ( )<br>D0              | ( )<br>D1              |                        |                        |            |            |            |            |            |            |            |                        | ( )<br>D33             | ( )<br>V <sub>CC</sub> | ( )<br>V <sub>SS</sub> |                        | 14 |
| 15 | ( )<br>V <sub>CC</sub> | ( )<br>V <sub>SS</sub> | ( )<br>D2              | ( )<br>D3              | ( )<br>D5              | ( )<br>D7  | ( )<br>D11 | ( )<br>D13 | ( )<br>D17 | ( )<br>D21 | ( )<br>D23 | ( )<br>D27 | ( )<br>D29             | ( )<br>D31             | ( )<br>D32             | ( )<br>V <sub>SS</sub> | ( )<br>V <sub>CC</sub> | 15 |
| 16 | ( )<br>V <sub>SS</sub> | ( )<br>V <sub>CC</sub> | ( )<br>V <sub>SS</sub> | ( )<br>V <sub>CC</sub> | ( )<br>D4              | ( )<br>D9  | ( )<br>D8  | ( )<br>D15 | ( )<br>D14 | ( )<br>D19 | ( )<br>D22 | ( )<br>D25 | ( )<br>D28             | ( )<br>D30             | ( )<br>V <sub>SS</sub> | ( )<br>V <sub>CC</sub> | ( )<br>V <sub>SS</sub> | 16 |
| 17 | ( )<br>V <sub>CC</sub> | ( )<br>V <sub>SS</sub> | ( )<br>V <sub>CC</sub> | ( )<br>V <sub>SS</sub> | ( )<br>V <sub>CC</sub> | ( )<br>D6  | ( )<br>D10 | ( )<br>D12 | ( )<br>D16 | ( )<br>D18 | ( )<br>D20 | ( )<br>D24 | ( )<br>D26             | ( )<br>V <sub>SS</sub> | ( )<br>V <sub>CC</sub> | ( )<br>V <sub>SS</sub> | ( )<br>V <sub>CC</sub> | 17 |

Figure 5.1 168-Pin Ceramic Pin Grid Array. Pin Configuration—View from Top Side







Table 5.1 168-Pin Ceramic PGA Pin Assignment by Location

| Location | Signal | Location | Signal | Location | Signal | Location | Signal  |
|----------|--------|----------|--------|----------|--------|----------|---------|
| A1       | VCC    | C9       | D47    | J15      | D17    | Q10      | BE6     |
| A2       | VSS    | C10      | D43    | J16      | D14    | Q11      | BE4     |
| A3       | VCC    | C11      | D39    | J17      | D16    | Q12      | BE0     |
| A4       | VSS    | C12      | D37    | K1       | A21    | Q13      | BSCN    |
| A5       | D56    | C13      | D35    | K2       | A18    | Q14      | D1      |
| A6       | D52    | C14      | D33    | K3       | A16    | Q15      | D2      |
| A7       | D50    | C15      | D32    | K15      | D13    | Q16      | VSS     |
| A8       | D48    | C16      | VSS    | K16      | D15    | Q17      | VCC     |
| A9       | D46    | C17      | VCC    | K17      | D12    | R1       | VSS     |
| A10      | D44    | D1       | VSS    | L1       | A19    | R2       | VCC     |
| A11      | D40    | D2       | VCC    | L2       | A15    | R3       | VSS     |
| A12      | D38    | D3       | D62    | L3       | A14    | R4       | VCC     |
| A13      | VCC    | D15      | D31    | L15      | D11    | R5       | A4      |
| A14      | VSS    | D16      | D30    | L16      | D8     | R6       | NENE    |
| A15      | VCC    | D17      | VSS    | L17      | D10    | R7       | HLDA    |
| A16      | VSS    | E1       | VCC    | M1       | A17    | R8       | KEN     |
| A17      | VCC    | E2       | CC0    | M2       | A13    | R9       | NA      |
| B1       | VSS    | E3       | CC1    | M3       | A11    | R10      | BE7     |
| B2       | VCC    | E15      | D29    | M15      | D7     | R11      | BE2     |
| B3       | VSS    | E16      | D28    | M16      | D9     | R12      | BE1     |
| B4       | D59    | E17      | D26    | M17      | D6     | R13      | SCAN    |
| B5       | D58    | F1       | A31    | N1       | A12    | R14      | D0      |
| B6       | D54    | F2       | A28    | N2       | A10    | R15      | VSS     |
| B7       | D53    | F3       | A30    | N3       | A9     | R16      | VCC     |
| B8       | D49    | F15      | D27    | N15      | D5     | R17      | VSS     |
| B9       | D45    | F16      | D25    | N16      | D4     | S1       | VCC     |
| B10      | D42    | F17      | D24    | N17      | VCC    | S2       | VSS     |
| B11      | D41    | G1       | A29    | P1       | VSS    | S3       | VCC     |
| B12      | D36    | G2       | A27    | P2       | A8     | S4       | VSS     |
| B13      | D34    | G3       | A26    | P3       | A7     | S5       | VCC     |
| B14      | VCC    | G15      | D23    | P15      | D3     | S6       | W/R     |
| B15      | VSS    | G16      | D22    | P16      | VCC    | S7       | ADS     |
| B16      | VCC    | G17      | D20    | P17      | VSS    | S8       | LOCK    |
| B17      | VSS    | H1       | A25    | Q1       | VCC    | S9       | INT/CS8 |
| C1       | VCC    | H2       | A24    | Q2       | VSS    | S10      | BE5     |
| C2       | VSS    | H3       | A22    | Q3       | A6     | S11      | BE3     |
| C3       | D60    | H15      | D21    | Q4       | A5     | S12      | SHI     |
| C4       | D63    | H16      | D19    | Q5       | A3     | S13      | RESET   |
| C5       | D61    | H17      | D18    | Q6       | PTB    | S14      | VSS     |
| C6       | D57    | J1       | A23    | Q7       | BREQ   | S15      | VCC     |
| C7       | D55    | J2       | A20    | Q8       | READY  | S16      | VSS     |
| C8       | D51    | J3       | CLK    | Q9       | HOLD   | S17      | VCC     |





Table 5.2 168-Pin Ceramic PGA Pin Assignment by Function

| Address         | Data            | Data            | Control                   | Vcc             | Vss             |
|-----------------|-----------------|-----------------|---------------------------|-----------------|-----------------|
| Signal Location | Signal Location | Signal Location | Signal Location           | Signal Location | Signal Location |
| A3.....Q5       | D0.....R14      | D32.....C15     | $\overline{ADS}$ .....S7  | VCC.....A1      | VSS.....A2      |
| A4.....R5       | D1.....Q14      | D33.....C14     | BE0.....Q12               | VCC.....A3      | VSS.....A4      |
| A5.....Q4       | D2.....Q15      | D34.....B13     | BE1.....R12               | VCC.....A13     | VSS.....A14     |
| A6.....Q3       | D3.....P15      | D35.....C13     | $\overline{BE2}$ .....R11 | VCC.....A15     | VSS.....A16     |
| A7.....P3       | D4.....N16      | D36.....B12     | BE3.....S11               | VCC.....A17     | VSS.....B1      |
| A8.....P2       | D5.....N15      | D37.....C12     | BE4.....Q11               | VCC.....B2      | VSS.....B3      |
| A9.....N3       | D6.....M17      | D38.....A12     | $\overline{BE5}$ .....S10 | VCC.....B14     | VSS.....B15     |
| A10.....N2      | D7.....M15      | D39.....C11     | BE6.....Q10               | VCC.....B16     | VSS.....B17     |
| A11.....M3      | D8.....L16      | D40.....A11     | BE7.....R10               | VCC.....C1      | VSS.....C2      |
| A12.....N1      | D9.....M16      | D41.....B11     | BREQ.....Q7               | VCC.....C17     | VSS.....C16     |
| A13.....M2      | D10.....L17     | D42.....B10     | BSCN.....Q13              | VCC.....D2      | VSS.....D1      |
| A14.....L3      | D11.....L15     | D43.....C10     | CC0.....E2                | VCC.....E1      | VSS.....D17     |
| A15.....L2      | D12.....K17     | D44.....A10     | CC1.....E3                | VCC.....N17     | VSS.....P1      |
| A16.....K3      | D13.....K15     | D45.....B9      | CLK.....J3                | VCC.....P16     | VSS.....P17     |
| A17.....M1      | D14.....J16     | D46.....A9      | HLDA.....R7               | VCC.....Q1      | VSS.....Q2      |
| A18.....K2      | D15.....K16     | D47.....C9      | HOLD.....Q9               | VCC.....Q17     | VSS.....Q16     |
| A19.....L1      | D16.....J17     | D48.....A8      | INT/CS8.....S9            | VCC.....R2      | VSS.....R1      |
| A20.....J2      | D17.....J15     | D49.....B8      | KEN.....R8                | VCC.....R4      | VSS.....R3      |
| A21.....K1      | D18.....H17     | D50.....A7      | $\overline{LOCK}$ .....S8 | VCC.....R16     | VSS.....R15     |
| A22.....H3      | D19.....H16     | D51.....C8      | NA.....R9                 | VCC.....S1      | VSS.....R17     |
| A23.....J1      | D20.....G17     | D52.....A6      | NENE.....R6               | VCC.....S3      | VSS.....S2      |
| A24.....H2      | D21.....H15     | D53.....B7      | PTB.....Q6                | VCC.....S5      | VSS.....S4      |
| A25.....H1      | D22.....G16     | D54.....B6      | READY.....Q8              | VCC.....S15     | VSS.....S14     |
| A26.....G3      | D23.....G15     | D55.....C7      | RESET.....S13             | VCC.....S17     | VSS.....S16     |
| A27.....G2      | D24.....F17     | D56.....A5      | SCAN.....R13              |                 |                 |
| A28.....F2      | D25.....F16     | D57.....C6      | SHI.....S12               |                 |                 |
| A29.....G1      | D26.....E17     | D58.....B5      | W/R.....S6                |                 |                 |
| A30.....F3      | D27.....F15     | D59.....B4      |                           |                 |                 |
| A31.....F1      | D28.....E16     | D60.....C3      |                           |                 |                 |
|                 | D29.....E15     | D61.....C5      |                           |                 |                 |
|                 | D30.....D16     | D62.....D3      |                           |                 |                 |
|                 | D31.....D15     | D63.....C4      |                           |                 |                 |

**Table 5.3 196-Pin Ceramic Quad Flatpack (CQFP) Pin Assignment by Location**

| Pin | Signal | Pin | Signal | Pin | Signal  | Pin | Signal |
|-----|--------|-----|--------|-----|---------|-----|--------|
| 1   | D60    | 50  | D27    | 99  | SCAN    | 148 | A9     |
| 2   | D59    | 51  | D26    | 100 | BSCN    | 149 | A10    |
| 3   | D58    | 52  | D25    | 101 | SHI     | 150 | A11    |
| 4   | D57    | 53  | D24    | 102 | BE0     | 151 | A12    |
| 5   | D56    | 54  | D23    | 103 | BE1     | 152 | A13    |
| 6   | D55    | 55  | VSS    | 104 | VSS     | 153 | VSS    |
| 7   | D54    | 56  | D22    | 105 | BE2     | 154 | CLK    |
| 8   | D53    | 57  | VCC    | 106 | VCC     | 155 | VCC    |
| 9   | D52    | 58  | D21    | 107 | BE3     | 156 | A14    |
| 10  | D51    | 59  | VSS    | 108 | VSS     | 157 | VSS    |
| 11  | VCC    | 60  | D20    | 109 | BE4     | 158 | A15    |
| 12  | D50    | 61  | VCC    | 110 | VCC     | 159 | VCC    |
| 13  | VSS    | 62  | D19    | 111 | BE5     | 160 | A16    |
| 14  | D49    | 63  | VSS    | 112 | VSS     | 161 | VSS    |
| 15  | VCC    | 64  | D18    | 113 | BE6     | 162 | A17    |
| 16  | D48    | 65  | VCC    | 114 | VCC     | 163 | VCC    |
| 17  | VSS    | 66  | D17    | 115 | BE7     | 164 | A18    |
| 18  | D47    | 67  | VSS    | 116 | VSS     | 165 | VSS    |
| 19  | VCC    | 68  | D16    | 117 | HOLD    | 166 | A19    |
| 20  | D46    | 69  | VCC    | 118 | VCC     | 167 | VCC    |
| 21  | VSS    | 70  | D15    | 119 | INT/CS8 | 168 | A20    |
| 22  | D45    | 71  | VSS    | 120 | VSS     | 169 | VSS    |
| 23  | VCC    | 72  | D14    | 121 | NA      | 170 | A21    |
| 24  | D44    | 73  | VCC    | 122 | VCC     | 171 | VCC    |
| 25  | VSS    | 74  | D13    | 123 | KEN     | 172 | A22    |
| 26  | D43    | 75  | VSS    | 124 | VSS     | 173 | VSS    |
| 27  | VCC    | 76  | D12    | 125 | READY   | 174 | A23    |
| 28  | D42    | 77  | VCC    | 126 | VCC     | 175 | VCC    |
| 29  | VSS    | 78  | D11    | 127 | LOCK    | 176 | A24    |
| 30  | D41    | 79  | VSS    | 128 | VSS     | 177 | VSS    |
| 31  | VCC    | 80  | D10    | 129 | HLDA    | 178 | A25    |
| 32  | D40    | 81  | VCC    | 130 | VCC     | 179 | VCC    |
| 33  | VSS    | 82  | D9     | 131 | ADS     | 180 | A26    |
| 34  | D39    | 83  | VSS    | 132 | VSS     | 181 | VSS    |
| 35  | VCC    | 84  | D8     | 133 | BREQ    | 182 | A27    |
| 36  | D38    | 85  | VCC    | 134 | VCC     | 183 | VCC    |
| 37  | VSS    | 86  | D7     | 135 | W/R     | 184 | A28    |
| 38  | D37    | 87  | VSS    | 136 | VSS     | 185 | VSS    |
| 39  | VCC    | 88  | D6     | 137 | PTB     | 186 | A29    |
| 40  | D36    | 89  | VCC    | 138 | VCC     | 187 | VCC    |
| 41  | VSS    | 90  | D5     | 139 | NENE    | 188 | A30    |
| 42  | D35    | 91  | VSS    | 140 | VSS     | 189 | VSS    |
| 43  | D34    | 92  | D4     | 141 | A3      | 190 | A31    |
| 44  | D33    | 93  | VCC    | 142 | VCC     | 191 | VCC    |
| 45  | D32    | 94  | D3     | 143 | A4      | 192 | CC0    |
| 46  | D31    | 95  | D2     | 144 | A5      | 193 | CC1    |
| 47  | D30    | 96  | D1     | 145 | A6      | 194 | D63    |
| 48  | D29    | 97  | D0     | 146 | A7      | 195 | D62    |
| 49  | D28    | 98  | RESET  | 147 | A8      | 196 | D61    |

**PRELIMINARY**



Table 5.4 196-Pin Ceramic Quad Flatpack (CQFP) Pin Assignment by Function

| Signal | Pin | Signal           | Pin | Signal             | Pin | Signal | Pin |
|--------|-----|------------------|-----|--------------------|-----|--------|-----|
| A3     | 141 | D20              | 60  | $\overline{BE4}$   | 109 | VCC    | 142 |
| A4     | 143 | D21              | 58  | BE5                | 111 | VCC    | 155 |
| A5     | 144 | D22              | 56  | $\overline{BE6}$   | 113 | VCC    | 159 |
| A6     | 145 | D23              | 54  | $\overline{BE7}$   | 115 | VCC    | 163 |
| A7     | 146 | D24              | 53  | BREQ               | 133 | VCC    | 167 |
| A8     | 147 | D25              | 52  | BSCN               | 100 | VCC    | 171 |
| A9     | 148 | D26              | 51  | CC0                | 192 | VCC    | 175 |
| A10    | 149 | D27              | 50  | CC1                | 193 | VCC    | 179 |
| A11    | 150 | D28              | 49  | CLK                | 154 | VCC    | 183 |
| A12    | 151 | D29              | 48  | HLDA               | 129 | VCC    | 187 |
| A13    | 152 | D30              | 47  | HOLD               | 117 | VCC    | 191 |
| A14    | 156 | D31              | 46  | INT/CS8            | 119 | VSS    | 13  |
| A15    | 158 | D32              | 45  | $\overline{KEN}$   | 123 | VSS    | 17  |
| A16    | 160 | D33              | 44  | $\overline{LOCK}$  | 127 | VSS    | 21  |
| A17    | 162 | D34              | 43  | $\overline{NA}$    | 121 | VSS    | 25  |
| A18    | 164 | D35              | 42  | $\overline{NEN}$   | 139 | VSS    | 29  |
| A19    | 166 | D36              | 40  | PTB                | 137 | VSS    | 33  |
| A20    | 168 | D37              | 38  | $\overline{READY}$ | 125 | VSS    | 37  |
| A21    | 170 | D38              | 36  | RESET              | 98  | VSS    | 41  |
| A22    | 172 | D39              | 34  | SCAN               | 99  | VSS    | 55  |
| A23    | 174 | D40              | 32  | SHI                | 101 | VSS    | 59  |
| A24    | 176 | D41              | 30  | W/R                | 135 | VSS    | 63  |
| A25    | 178 | D42              | 28  | VCC                | 11  | VSS    | 67  |
| A26    | 180 | D43              | 26  | VCC                | 15  | VSS    | 71  |
| A27    | 182 | D44              | 24  | VCC                | 19  | VSS    | 75  |
| A28    | 184 | D45              | 22  | VCC                | 23  | VSS    | 79  |
| A29    | 186 | D46              | 20  | VCC                | 27  | VSS    | 83  |
| A30    | 188 | D47              | 18  | VCC                | 31  | VSS    | 87  |
| A31    | 190 | D48              | 16  | VCC                | 35  | VSS    | 91  |
| D0     | 97  | D49              | 14  | VCC                | 39  | VSS    | 104 |
| D1     | 96  | D50              | 12  | VCC                | 57  | VSS    | 108 |
| D2     | 95  | D51              | 10  | VCC                | 61  | VSS    | 112 |
| D3     | 94  | D52              | 9   | VCC                | 65  | VSS    | 116 |
| D4     | 92  | D53              | 8   | VCC                | 69  | VSS    | 120 |
| D5     | 90  | D54              | 7   | VCC                | 73  | VSS    | 124 |
| D6     | 88  | D55              | 6   | VCC                | 77  | VSS    | 128 |
| D7     | 86  | D56              | 5   | VCC                | 81  | VSS    | 132 |
| D8     | 84  | D57              | 4   | VCC                | 85  | VSS    | 136 |
| D9     | 82  | D58              | 3   | VCC                | 89  | VSS    | 140 |
| D10    | 80  | D59              | 2   | VCC                | 93  | VSS    | 153 |
| D11    | 78  | D60              | 1   | VCC                | 106 | VSS    | 157 |
| D12    | 76  | D61              | 196 | VCC                | 110 | VSS    | 161 |
| D13    | 74  | D62              | 195 | VCC                | 114 | VSS    | 165 |
| D14    | 72  | D63              | 194 | VCC                | 118 | VSS    | 169 |
| D15    | 70  | $\overline{ADS}$ | 131 | VCC                | 122 | VSS    | 173 |
| D16    | 68  | $\overline{BE0}$ | 102 | VCC                | 126 | VSS    | 177 |
| D17    | 66  | $\overline{BE1}$ | 103 | VCC                | 130 | VSS    | 181 |
| D18    | 64  | $\overline{BE2}$ | 105 | VCC                | 134 | VSS    | 185 |
| D19    | 62  | BE3              | 107 | VCC                | 138 | VSS    | 189 |

**6.0 ELECTRICAL DATA**

Inputs and outputs are TTL compatible. All input and output timings are specified relative to the 1.5 volt level of the rising edge of CLK and refer to the point that the signals reach 1.5V.

NOTICE: This data sheet contains preliminary information on new products in production. The specifications are subject to change without notice. Verify with your local Intel Sales office that you have the latest data sheet before finalizing a design.

*\*WARNING: Stressing the device beyond the "Absolute Maximum Ratings" may cause permanent damage. These are stress ratings only. Operation beyond the "Operating Conditions" is not recommended and extended exposure beyond the "Operating Conditions" may affect device reliability.*

**6.1 Absolute Maximum Ratings**

Case Temperature  $T_C$  under Bias  $-55^{\circ}\text{C}$  to  $+125^{\circ}\text{C}$   
 Storage Temperature .....  $-65^{\circ}\text{C}$  to  $+150^{\circ}\text{C}$   
 Voltage on Any Pin  
 with Respect to Ground .....  $-0.5$  to  $6.5\text{V}$

**6.2 Operating Conditions**

| Symbol   | Parameter                     | Min  | Max  | Units              |
|----------|-------------------------------|------|------|--------------------|
| $T_C$    | Case Temperature (Instant On) | -55  | +125 | $^{\circ}\text{C}$ |
| $V_{CC}$ | Digital Supply Voltage        | 4.75 | 5.25 | V                  |

**6.3 DC Characteristics** (Over Specified Operating Conditions)

**Table 6.1 DC Characteristics**

| Symbol        | Parameter   | Min      | Max            | Units  | Notes                        |
|---------------|---|----------|----------------|--|------------------------------|
| $V_{IL}$      | Input LOW Voltage   | -0.3     | +0.8           | V  |                              |
| $V_{IH}$      | Input HIGH Voltage  | 2.0      | $V_{CC} + 0.3$ | V  |                              |
| $V_{ILC}$     | CLK Input LOW Voltage   | -0.3     | +0.8           | V  |                              |
| $V_{IHC}$     | CLK Input HIGH Voltage  | 3.0      | $V_{CC} + 0.3$ | V  |                              |
| $V_{OL}$      | Output LOW Voltage  |          | 0.45           | V  | (Note 1)                     |
| $V_{OH}$      | Output HIGH Voltage   | 2.4      |                | V  | (Note 2)                     |
| $I_{CC}$      | Power Supply Current<br>CLK = 25.0 MHz, 33.3 MHz<br>CLK = 40.0 MHz                  |          | 600<br>650     | mA<br>mA   | $V_{CC}$ @5V<br>$V_{CC}$ @5V |
| $I_{LI}$      | Input Leakage Current   |          | $\pm 15$       | $\mu\text{A}$  | No pullup or pulldown        |
| $I_{LO}$      | Output Leakage Current  |          | $\pm 15$       | $\mu\text{A}$  |                              |
| $C_{IN}$      | Input Capacitance   |          | 15             | pF   | (Note 3)                     |
| $C_O$         | I/O or Output Capacitance   |          | 15             | pF   | (Note 3)                     |
| $C_{CLK}$     | Clock Capacitance   |          | 20             | pF   | (Note 3)                     |
| $\theta_{JA}$ | Thermal Resistance (Junction-to-Ambient)<br>Pin Grid Array<br>Ceramic Quad Flatpack | NA<br>NA | 17<br>23       | $^{\circ}\text{C}/\text{W}$<br>$^{\circ}\text{C}/\text{W}$ |                              |
| $\theta_{JC}$ | Thermal Resistance (Junction-to-Case)<br>Pin Grid Array<br>Ceramic Quad Flatpack    | NA<br>NA | 1.5<br>7       | $^{\circ}\text{C}/\text{W}$<br>$^{\circ}\text{C}/\text{W}$ |                              |

**NOTES:**

1. This parameter is measured at 4.0 mA for A31-A3, D63-D0,  $\overline{BE7}$ - $\overline{BE0}$ ; at 5.0 mA for all other outputs.
2. This parameter is measured at 1.0 mA for A31-A3, D63-D0,  $\overline{BE7}$ - $\overline{BE0}$ ; at 0.9 mA all other outputs.
3. These parameters are not tested. They are guaranteed by design characterization.

**PRELIMINARY**

## 6.4 AC Characteristics (Over Specified Operating Conditions)

**Table 6.2 AC Characteristics**  
All timings measured at CLK = 1.5V unless otherwise specified.

| Symbol | Parameter  | 25 MHz   |          | 33 MHz   |          | 40 MHz   |          | Notes      |
|--------|--|----------|----------|----------|----------|----------|----------|------------|
|        |  | Min (ns) | Max (ns) | Min (ns) | Max (ns) | Min (ns) | Max (ns) |            |
| t1     | CLK Period   | 40       | 125      | 30       | 125      | 25       | 125      |            |
| t2     | CLK High Time  | 10       |          | 7        |          | 5        |          | at 3V      |
| t3     | CLK Low Time   | 10       |          | 7        |          | 5        |          | at 0.8V    |
| t4     | CLK Fall Time  |          | 7        |          | 7        |          | 7        | 3V–0.8V    |
| t5     | CLK Rise Time  |          | 7        |          | 7        |          | 7        | 0.8V–3V    |
| t6a    | A31–A3, PTB, W/ $\bar{R}$ , $\bar{NEN}$<br>Valid Delay | 3.5      | 43       | 3.5      | 23       | 3.5      | 21       | 50 pF load |
| t6b    | $\bar{BEN}^*$ Valid Delay                              | 3.5      | 25       | 3.5      | 25       | 3.5      | 23       | 50 pF load |
| t7     | Float Time, All Outputs                                | 3.5      | 40       | 3.5      | 30       | 3.5      | 25       | (Note 1)   |
| t8     | $\bar{ADS}$ , BREQ, $\bar{LOCK}$ , HLDA<br>Valid Delay | 3.5      | 29       | 3.5      | 20       | 3.5      | 15       | 50 pF load |
| t9     | D63–D0 Valid Delay                                     | 3.5      | 60       | 3.5      | 35       | 3.5      | 33       | 50 pF load |
| t10a   | Setup Time, All Inputs<br>except DATA                  | 16       |          | 11       |          | 8        |          | (Note 2)   |
| t11a   | Hold Time, All Inputs<br>except DATA                   | 7        |          | 4        |          | 3        |          | (Note 2)   |
| t10b   | DATA Setup Time  | 16       |          | 11       |          | 10       |          |            |
| t11b   | DATA Hold Time   | 7        |          | 4        |          | 3        |          |            |

### NOTES:

1. Float condition occurs when maximum output current becomes less than  $I_{LO}$  in magnitude. Float delay is not tested.
  2. INT and HOLD are asynchronous inputs. The setup and hold specifications are given for test purposes or to assure recognition on a specific rising edge of CLK. INT should remain asserted until software acknowledges the interrupt.
- \*n = 0, 1, . . . , 7



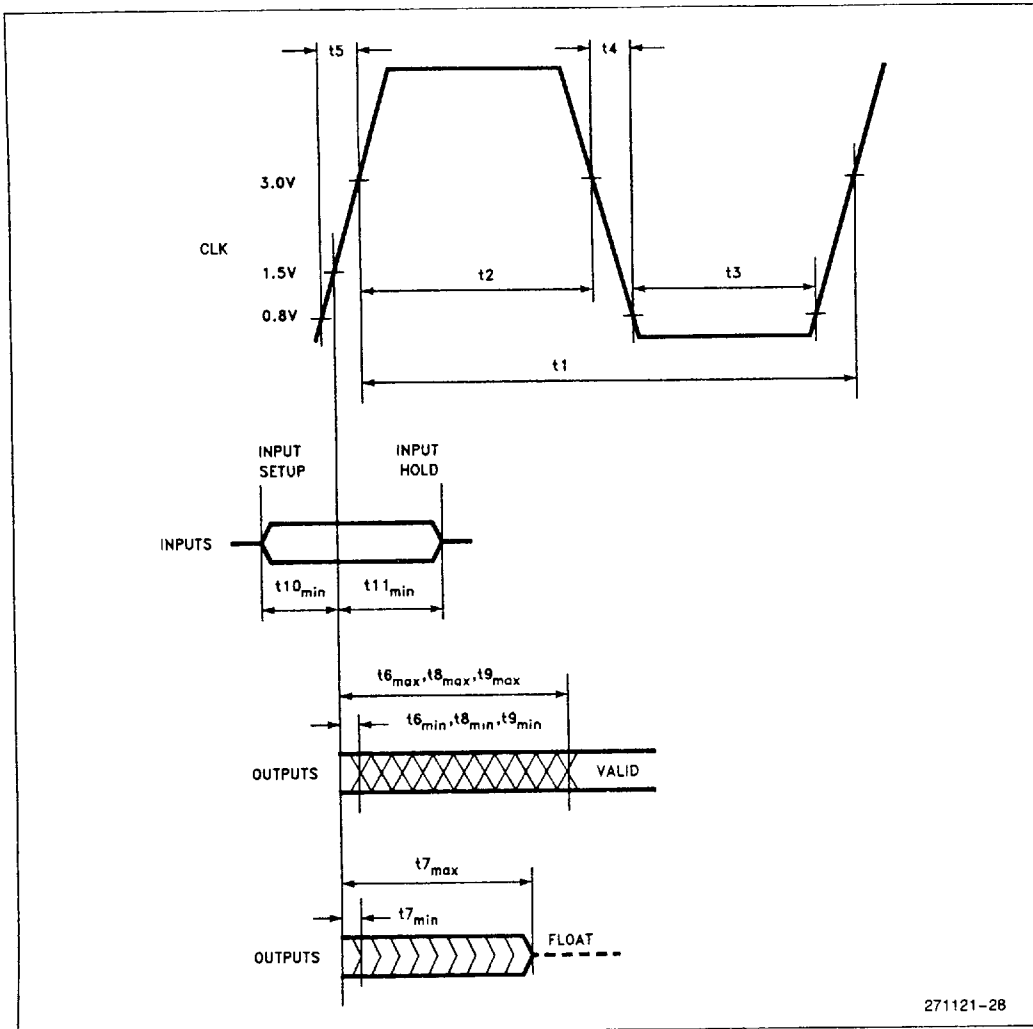

Figure 6.1 CLK, Input and Output Timings



## 7.0 INSTRUCTION SET

Key to abbreviations:

For register operands, the abbreviations that describe the operands are composed of two parts. The first part describes the type of register:

|          |  |
|----------|--|
| <i>c</i> | One of the control registers: <b>fir</b> , <b>psr</b> , <b>epsr</b> , <b>dirbase</b> , <b>db</b> or <b>fsr</b> |
| <i>f</i> | One of the floating-point registers: <b>f0</b> through <b>f31</b>  |
| <i>i</i> | One of the integer registers: <b>r0</b> through <b>r31</b>   |

The second part identifies the field of the machine instruction into which the operand is to be placed:

|               |   |
|---------------|---|
| <i>src1</i>   | The first of the two source-register designators, which may be either a register or a 16-bit immediate constant or address offset. The immediate value is zero-extended for logical operations and is sign-extended for add and subtract operations (including <b>addu</b> and <b>subu</b> ) and for all addressing calculations. |
| <i>src1ni</i> | Same as <i>src1</i> except that no immediate constant or address offset value is permitted.   |
| <i>src1s</i>  | Same as <i>src1</i> except that the immediate constant is a 5-bit value that is zero-extended to 32 bits.   |
| <i>src2</i>   | The second of the two source-register designators.  |
| <i>dest</i>   | The destination register designator.  |

Thus, the operand specifier *isrc2*, for example, means that an integer register is used and that the encoding of that register must be placed in the *src2* field of the machine instruction.

Other (nonregister) operands are specified by a one-part abbreviation that represents both the type of operand required and the instruction field into which the value of the operand is placed:

|               |   |
|---------------|---|
| <i>#const</i> | A 16-bit immediate constant or address offset that the i860 XR microprocessor sign-extends to 32 bits when computing the effective address.   |
| <i>lbroff</i> | A signed, 26-bit, immediate, relative branch offset.  |
| <i>sbroff</i> | A signed, 16-bit, immediate, relative branch offset.  |
| <i>brx</i>    | A function that computes the target address by shifting the offset (either <i>lbroff</i> or <i>sbroff</i> ) left by two bits, sign-extending it to 32 bits, and adding the result to the current instruction pointer plus four. The resulting target address may lie anywhere within the address space. |

Unless otherwise specified, floating-point operations accept single- or double-precision source operands and produce a result of equal or greater precision. Both input operands must have the same precision. The source and result precision are specified by a two-letter suffix to the mnemonic of the operation.

Other abbreviations include:

- .p** Precision specification **.ss**, **.sd** or **.dd** (**.ds** not permitted). Refer to Table 7.1.
- .r** Precision specification **.ss**, **.sd**, **.ds** or **.dd**. Refer to Table 7.1.
- .v** **.sd** or **.dd**. Refer to Table 7.1.
- .w** **.ss** or **.dd**. Refer to Table 7.1.
- .x** **.b** (8 bits), **.s** (16 bits), or **.l** (32 bits)
- .y** **.l** (32 bits), **.d** (64 bits), or **.q** (128 bits)
- .z** **.l** (32 bits), or **.d** (64 bits)
- mem.x(address)* The contents of the memory location indicated by *address* with a size of *x*.
- PM** The pixel mask, which is considered as an array of eight bits PM[7]..PM[0], where PM[0] is the least significant bit.

**Table 7.1 Precision Specification**

| Suffix     | Source Precision | Result Precision |
|------------|------------------|------------------|
| <b>.ss</b> | single           | single           |
| <b>.sd</b> | single           | double           |
| <b>.dd</b> | double           | double           |
| <b>.ds</b> | double           | single           |

**7.1 Instruction Definitions in Alphabetical Order**

- adds** *isrc1, isrc2, idest* ..... **Add Signed**  
 $idest \leftarrow isrc1 + isrc2$   
 OF  $\leftarrow$  (bit 31 carry  $\neq$  bit 30 carry)  
 CC set if *isrc2* < -*isrc1* (signed)  
 CC clear if *isrc2*  $\geq$  -*isrc1* (signed)
- addu** *isrc1, isrc2, idest* ..... **Add Unsigned**  
 $idest \leftarrow isrc1 + isrc2$   
 OF  $\leftarrow$  bit 31 carry  
 CC  $\leftarrow$  bit 31 carry
- and** *isrc1, isrc2, idest* ..... **Logical AND**  
 $idest \leftarrow isrc1 \text{ and } isrc2$   
 CC set if result is zero, cleared otherwise
- andh** *#const, isrc2, idest* ..... **Logical AND High**  
 $idest \leftarrow (\#const \text{ shifted left 16 bits}) \text{ and } isrc2$   
 CC set if result is zero, cleared otherwise
- andnot** *isrc1, isrc2, idest* ..... **Logical AND NOT**  
 $idest \leftarrow \text{not } isrc1 \text{ and } isrc2$   
 CC set if result is zero, cleared otherwise
- andnoth** *#const, isrc2, idest* ..... **Logical AND NOT High**  
 $idest \leftarrow \text{not } (\#const \text{ shifted left 16 bits}) \text{ and } isrc2$   
 CC set if result is zero, cleared otherwise
- bc** *lbroff* ..... **Branch on CC**  
 IF CC = 1  
 THEN continue execution at *brx(lbroff)*  
 FI



```

bc.t      lbroff ..... Branch on CC, Taken
IF      CC = 1
THEN    execute one more sequential instruction
        continue execution at brx(lbroff)
ELSE    skip next sequential instruction
FI

bla      isrc1ni, isrc2, sbroff ..... Branch on LCC and Add
        LCC-temp clear if isrc2 <  $-isrc1ni$  (signed)
        LCC-temp set if isrc2 ≥  $-isrc1ni$  (signed)
isrc2 ← isrc1ni + isrc2
Execute one more sequential instruction
IF      LCC
THEN    LCC ← LCC-temp
        continue execution at brx(sbroff)
ELSE    LCC ← LCC-temp
FI

bnc      lbroff ..... Branch on Not CC
IF      CC = 0
THEN    continue execution at brx(lbroff)
FI

bnc.t    lbroff ..... Branch on Not CC, Taken
IF      CC = 0
THEN    execute one more sequential instruction
        continue execution at brx(lbroff)
ELSE    skip next sequential instruction
FI

br       lbroff ..... Branch Direct Unconditionally
Execute one more sequential instruction.
Continue execution at brx(lbroff).

bri      [isrc1ni] ..... Branch Indirect Unconditionally
Execute one more sequential instruction
IF      any trap bit in psr is set
THEN    copy PU to U, PIM to IM in psr
        clear trap bits
        IF      DS is set and DIM is reset
        THEN    enter dual-instruction mode after executing one
                instruction in single-instruction mode
        ELSE    IF      DS is set and DIM is set
        THEN    enter single-instruction mode after executing one
                instruction in dual-instruction mode
        ELSE    IF      DIM is set
        THEN    enter dual-instruction mode
                for next two instructions
        ELSE    enter single-instruction mode
                for next two instructions
        FI
        FI
        FI
Continue execution at address in isrc1ni
(The original contents of isrc1ni is used even if the next instruction
modifies isrc1ni. Does not trap if isrc1ni is misaligned.)

bte      isrc1s, isrc2, sbroff ..... Branch If Equal
IF      isrc1s = isrc2
THEN    continue execution at brx(sbroff)
FI

```

|                 |   |   |
|-----------------|---|---|
| <b>btne</b>     | <i>isrc1s, isrc2, sbroff</i> .....  | <b>Branch If Not Equal</b>                  |
| IF              | <i>isrc1s</i> ≠ <i>isrc2</i>  |   |
| THEN            | continue execution at <i>brx(sbroff)</i>  |   |
| FI              |   |   |
| <b>call</b>     | <i>lbroff</i> .....   | <b>Subroutine Call</b>                      |
|                 | <i>r1</i> ← address of next sequential instruction + 4 (+8 in dual mode)  |   |
|                 | Execute one more sequential instruction   |   |
|                 | Continue execution at <i>brx(lbroff)</i>  |   |
| <b>calli</b>    | [ <i>isrc1ni</i> ] .....  | <b>Indirect Subroutine Call</b>             |
|                 | <i>r1</i> ← address of next sequential instruction + 4 (+8 in dual mode)  |   |
|                 | Execute one more sequential instruction   |   |
|                 | Continue execution at address in <i>isrc1ni</i>   |   |
|                 | (The original contents of <i>isrc1ni</i> is used even if the next instruction modifies <i>isrc1ni</i> . Does not trap if <i>isrc1ni</i> is misaligned. The register <i>isrc1ni</i> must not be <i>r1</i> .) |   |
| <b>fadd.p</b>   | <i>fsrc1, fsrc2, fdest</i> .....  | <b>Floating-Point Add</b>                   |
|                 | <i>fdest</i> ← <i>fsrc1</i> + <i>fsrc2</i>  |   |
| <b>faddp</b>    | <i>fsrc1, fsrc2, fdest</i> .....  | <b>Add with Pixel Merge</b>                 |
|                 | <i>fdest</i> ← <i>fsrc1</i> + <i>fsrc2</i>  |   |
|                 | Shift and load MERGE register as defined in Table 7.2   |   |
| <b>faddz</b>    | <i>fsrc1, fsrc2, fdest</i> .....  | <b>Add with Z Merge</b>                     |
|                 | <i>fdest</i> ← <i>fsrc1</i> + <i>fsrc2</i>  |   |
|                 | Shift MERGE right 16 and load fields 31..16 and 63..48  |   |
| <b>famov.r</b>  | <i>fsrc1, fdest</i> .....   | <b>Floating-Point Adder Move</b>            |
|                 | <i>fdest</i> ← <i>fsrc1</i>   |   |
|                 | Send <i>fsrc1</i> through the floating-point adder. (Preserves -0 (minus zero) when <i>fsrc1</i> is -0. <i>fsrc2</i> must be coded as <b>f0</b> by the assembler.)  |   |
| <b>fiadd.w</b>  | <i>fsrc1, fsrc2, fdest</i> .....  | <b>Long-Integer Add</b>                     |
|                 | <i>fdest</i> ← <i>fsrc1</i> + <i>fsrc2</i>  |   |
| <b>fisub.w</b>  | <i>fsrc1, fsrc2, fdest</i> .....  | <b>Long-Integer Subtract</b>                |
|                 | <i>fdest</i> ← <i>fsrc1</i> - <i>fsrc2</i>  |   |
| <b>fix.v</b>    | <i>fsrc1, fdest</i> .....   | <b>Floating-Point to Integer Conversion</b> |
|                 | <i>fdest</i> ← 64-bit value with low-order 32 bits equal to integer part of <i>fsrc1</i> rounded  |   |
|                 |   | <b>Floating-Point Load</b>                  |
| <b>fld.y</b>    | <i>isrc1(isrc2), fdest</i> .....  | <b>(Normal)</b>                             |
| <b>fld.y</b>    | <i>isrc1(isrc2)++</i> , <i>fdest</i> .....  | <b>(Autoincrement)</b>                      |
|                 | <i>fdest</i> ← mem.y ( <i>isrc1</i> + <i>isrc2</i> )  |   |
|                 | IF autoincrement  |   |
|                 | THEN <i>isrc2</i> ← <i>isrc1</i> + <i>isrc2</i>   |   |
|                 | FI  |   |
|                 |   | <b>Cache Flush</b>                          |
| <b>flush</b>    | # <i>const(isrc2)</i> .....   | <b>(Normal)</b>                             |
| <b>flush</b>    | # <i>const(isrc2)++</i> .....   | <b>(Autoincrement)</b>                      |
|                 | Replace block in data cache with address (# <i>const</i> + <i>isrc2</i> ). Contents of block undefined.   |   |
|                 | IF autoincrement  |   |
|                 | THEN <i>isrc2</i> ← # <i>const</i> + <i>isrc2</i>   |   |
|                 | FI  |   |
| <b>fmlow.dd</b> | <i>fsrc1, fsrc2, fdest</i> .....  | <b>Floating-Point Multiply Low</b>          |
|                 | <i>fdest</i> ← low-order 53 bits of <i>fsrc1</i> mantissa × <i>fsrc2</i> mantissa   |   |
|                 | <i>fdest</i> bit 53 ← most significant bit of mantissa  |   |



|                 |   |                                       |
|-----------------|---|---------------------------------------|
| <b>fmov.r</b>   | <i>fsrc1, fdest</i> .....   | Floating-Point Reg-Reg Move           |
|                 | Assembler pseudo-operation  |                                       |
|                 | <b>fmov.ss</b> <i>fsrc1, fdest</i> = <b>fiadd.ss</b> <i>fsrc1, f0, fdest</i>  |                                       |
|                 | <b>fmov.dd</b> <i>fsrc1, fdest</i> = <b>fiadd.dd</b> <i>fsrc1, f0, fdest</i>  |                                       |
|                 | <b>fmov.sd</b> <i>fsrc1, fdest</i> = <b>famov.sd</b> <i>fsrc1, fdest</i>  |                                       |
|                 | <b>fmov.ds</b> <i>fsrc1, fdest</i> = <b>famov.ds</b> <i>fsrc1, fdest</i>  |                                       |
| <b>fmul.p</b>   | <i>fsrc1, fsrc2, fdest</i> .....  | Floating-Point Multiply               |
|                 | <i>fdest</i> ← <i>fsrc1</i> × <i>fsrc2</i>  |                                       |
| <b>fnop</b>     | .....   | Floating-Point No Operation           |
|                 | Assembler pseudo-operation  |                                       |
|                 | <b>fnop</b> = <b>shrd</b> <i>r0, r0, r0</i>   |                                       |
| <b>form</b>     | <i>fsrc1, fdest</i> .....   | OR with MERGE Register                |
|                 | <i>fdest</i> ← <i>fsrc1</i> OR MERGE  |                                       |
|                 | MERGE ← 0   |                                       |
| <b>frcp.p</b>   | <i>fsrc2, fdest</i> .....   | Floating-Point Reciprocal             |
|                 | <i>fdest</i> ← 1/ <i>fsrc2</i> with maximum mantissa error < 2 <sup>-7</sup>  |                                       |
| <b>frsqr.p</b>  | <i>fsrc2, fdest</i> .....   | Floating-Point Reciprocal Square Root |
|                 | <i>fdest</i> ← 1/SQRT ( <i>fsrc2</i> ) with maximum mantissa error < 2 <sup>-7</sup>  |                                       |
|                 |   | Floating-Point Store                  |
| <b>fst.y</b>    | <i>fdest, isrc1(isrc2)</i> .....  | (Normal)                              |
| <b>fst.y</b>    | <i>fdest, isrc1(isrc2)++</i> .....  | (Autoincrement)                       |
|                 | mem.y ( <i>isrc2</i> + <i>isrc1</i> ) ← <i>fdest</i>  |                                       |
|                 | IF autoincrement  |                                       |
|                 | THEN <i>isrc2</i> ← <i>isrc1</i> + <i>isrc2</i>   |                                       |
|                 | FI  |                                       |
| <b>fsub.p</b>   | <i>fsrc1, fsrc2, fdest</i> .....  | Floating-Point Subtract               |
|                 | <i>fdest</i> ← <i>fsrc1</i> - <i>fsrc2</i>  |                                       |
| <b>ftrunc.v</b> | <i>fsrc1, fdest</i> .....   | Floating-Point to Integer Conversion  |
|                 | <i>fdest</i> ← 64-bit value with low-order 32 bits equal to integer part of <i>fsrc1</i>  |                                       |
| <b>fxfr</b>     | <i>fsrc1, idest</i> .....   | Transfer F-P to Integer Register      |
|                 | <i>idest</i> ← <i>fsrc1</i>   |                                       |
| <b>fzchk1</b>   | <i>fsrc1, fsrc2, fdest</i> .....  | 32-Bit Z-Buffer Check                 |
|                 | Consider <i>fsrc1</i> , <i>fsrc2</i> , and <i>fdest</i> as arrays of two 32-bit fields <i>fsrc1</i> (0).. <i>fsrc1</i> (1), <i>fsrc2</i> (0).. <i>fsrc2</i> (1), and <i>fdest</i> (0).. <i>fdest</i> (1) where zero denotes the least-significant field.  |                                       |
|                 | PM ← PM shifted right by 2 bits   |                                       |
|                 | FOR i = 0 to 1  |                                       |
|                 | DO  |                                       |
|                 | PM [i + 6] ← <i>fsrc2</i> (i) ≤ <i>fsrc1</i> (i) (unsigned)   |                                       |
|                 | <i>fdest</i> (i) ← smaller of <i>fsrc2</i> (i) and <i>fsrc1</i> (i)   |                                       |
|                 | OD  |                                       |
|                 | MERGE ← 0   |                                       |
| <b>fzchks</b>   | <i>fsrc1, fsrc2, fdest</i> .....  | 16-Bit Z-Buffer Check                 |
|                 | Consider <i>fsrc1</i> , <i>fsrc2</i> , and <i>fdest</i> as arrays of four 16-bit fields <i>fsrc1</i> (0).. <i>fsrc1</i> (3), <i>fsrc2</i> (0).. <i>fsrc2</i> (3), and <i>fdest</i> (0).. <i>fdest</i> (3) where zero denotes the least-significant field. |                                       |
|                 | PM ← PM shifted right by 4 bits   |                                       |
|                 | FOR i = 0 to 3  |                                       |
|                 | DO  |                                       |
|                 | PM [i + 4] ← <i>fsrc2</i> (i) ≤ <i>fsrc1</i> (i) (unsigned)   |                                       |
|                 | <i>fdest</i> (i) ← smaller of <i>fsrc2</i> (i) and <i>fsrc1</i> (i)   |                                       |
|                 | OD  |                                       |
|                 | MERGE ← 0   |                                       |
| <b>intovr</b>   | .....   | Software Trap on Integer Overflow     |
|                 | If OF in <b>epsr</b> = 1, generate trap with IT set in <b>psr</b> .   |                                       |

**ixfr**     *isrc1ni, fdest* ..... Transfer Integer to F-P Register  
*fdest* ← *isrc1ni*

**ld.c**     *csrc2, idest* ..... Load from Control Register  
*idest* ← *csrc2*

**ld.x**     *isrc1(isrc2), idest* ..... Load Integer  
*idest* ← *mem.x(isrc1 + isrc2)*

**lock** ..... Begin Interlocked Sequence  
Set BL in *dirbase*. The next load or store that misses the cache locks that location.  
Disable interrupts until the bus is unlocked.

**mov**     *isrc2, idest* ..... Register-Register Move  
Assembler pseudo-operation  
**mov** *isrc2, idest = shl r0, isrc2, idest*

**mov**     *const32, idest* ..... Constant-to-Register Move  
Assembler pseudo-operation  
**adds** *l%const32, r0, idest*  
... when *const32* < 0x8000

**orh** *h%const32, r0, idest*  
      **or** *l%const32, idest, idest*  
      ... when *const32* ≥ 0x8000

**nop** ..... Core-Unit No Operation  
Assembler pseudo-operation  
**nop** = *shl r0, r0, r0*

**or**     *isrc1, isrc2, idest* ..... Logical OR  
*idest* ← *isrc1* OR *isrc2*  
CC set if result is zero, cleared otherwise

**orh**     *#const, isrc2, idest* ..... Logical OR High  
*idest* ← (*#const* shifted left 16 bits) OR *isrc2*  
CC set if result is zero, cleared otherwise

**pfadd.p** *fsrc1, fsrc2, fdest* ..... Pipelined Floating-Point Add  
*fdest* ← last stage Adder result  
Advance A pipeline one stage  
A pipeline first stage ← *fsrc1 + fsrc2*

**pfaddp** *fsrc1, fsrc2, fdest* ..... Pipelined Add with Pixel Merge  
*fdest* ← last stage Graphics result  
last stage Graphics result ← *fsrc1 + fsrc2*  
Shift and load MERGE register from last stage Graphics result as defined in Table 7.2

**pfaddz** *fsrc1, fsrc2, fdest* ..... Pipelined Add with Z Merge  
*fdest* ← last stage Graphics result  
last stage Graphics result ← *fsrc1 + fsrc2*  
Shift MERGE right 16 and load fields 31..16 and 63..48 from last stage Graphics result

**pfam.p** *fsrc1, fsrc2, fdest* ..... Pipelined Floating-Point Add and Multiply  
*fdest* ← last stage Adder result  
Advance A and M pipeline one stage (operands accessed before advancing pipeline)  
A pipeline first stage ← A-op1 + A-op2  
M pipeline first stage ← M-op1 × M-op2

**pfamov.r** *fsrc1, fdest* ..... Pipelined Floating-Point Adder Move  
*fdest* ← last stage Adder result  
Advance A pipeline one stage  
A pipeline first stage ← *fsrc1*



- pfreq.p** *fsrc1, fsrc2, fdest* ..... **Pipelined Floating-Point Equal Compare**  
*fdest* ← last stage Adder result  
 CC set if *fsrc1* = *fsrc2*, else cleared  
 Advance A pipeline one stage  
 A pipeline first stage is undefined, but no result exception occurs
- pfgt.p** *fsrc1, fsrc2, fdest* ..... **Pipelined Floating-Point Greater-Than Compare**  
 (Assembler clears R-bit of instruction)  
*fdest* ← last stage Adder result  
 CC set if *fsrc1* > *fsrc2*, else cleared  
 Advance A pipeline one stage  
 A pipeline first stage is undefined, but no result exception occurs
- pfiadd.w** *fsrc1, fsrc2, fdest* ..... **Pipelined Long-Integer Add**  
*fdest* ← last stage Graphics result  
 last stage Graphics result ← *fsrc1* + *fsrc2*
- pfisub.w** *fsrc1, fsrc2, fdest* ..... **Pipelined Long-Integer Subtract**  
*fdest* ← last stage Graphics result  
 last stage Graphics result ← *fsrc1* - *fsrc2*
- pfiv.v** *fsrc1, fdest* ..... **Pipelined Floating-Point to Integer Conversion**  
*fdest* ← last stage Adder result  
 Advance A pipeline one stage  
 A pipeline first stage ← 64-bit value with low-order 32 bits  
 equal to integer part of *fsrc1* rounded
- Pipelined Floating-Point Load**
- pfld.z** *isrc1(isrc2), fdest* ..... (Normal)  
**pfld.z** *isrc1(isrc2) ++, fdest* ..... (Autoincrement)  
*fdest* ← mem.z (third previous **pfld**'s (*isrc1* + *isrc2*))  
 (where .z is precision of third previous **pfld.z**)  
 If autoincrement  
 THEN *isrc2* ← *isrc1* + *isrc2*  
 F)
- pfle.p** *fsrc1, fsrc2, fdest* ..... **Pipelined F-P Less-Than or Equal Compare**  
 Assembler pseudo-operation, identical to **pfgt.p** except that  
 assembler sets R-bit of instruction.  
*fdest* ← last stage Adder result  
 CC clear if *fsrc1* ≤ *fsrc2*, else set  
 Advance A pipeline one stage  
 A pipeline first stage is undefined, but no result exception occurs
- pfmam.p** *fsrc1, fsrc2, fdest* ..... **Pipelined Floating-Point Add and Multiply**  
*fdest* ← last stage Multiplier result  
 Advance A and M pipeline one stage (operands accessed before advancing pipeline)  
 A pipeline first stage ← A-op1 - A-op2  
 M pipeline first stage ← M-op1 × M-op2
- pfmov.r** *fsrc1, fdest* ..... **Pipelined Floating-Point Reg-Reg Move**  
 Assembler pseudo-operation  
**pfmov.ss** *fsrc1, fdest* = **pfisub.ss** *fsrc1, f0, fdest*  
**pfmov.dd** *fsrc1, fdest* = **pfisub.dd** *fsrc1, f0, fdest*  
**pfmov.sd** *fsrc1, fdest* = **pfisub.sd** *fsrc1, fdest*  
**pfmov.ds** *fsrc1, fdest* = **pfisub.ds** *fsrc1, fdest*
- pfmsm.p** *fsrc1, fsrc2, fdest* ..... **Pipelined Floating-Point Subtract and Multiply**  
*fdest* ← last stage Multiplier result  
 Advance A and M pipeline one stage (operands accessed before advancing pipeline)  
 A pipeline first stage ← A-op1 - A-op2  
 M pipeline first stage ← M-op1 × M-op2
- pfmul.p** *fsrc1, fsrc2, fdest* ..... **Pipelined Floating-Point Multiply**  
*fdest* ← last stage Multiplier result  
 Advance M pipeline one stage  
 M pipeline first stage ← *fsrc1* × *fsrc2*



**pfmul3.dd** *fsrc1, fsrc2, fdest* ..... **Three-Stage Pipelined Multiply**  
*fdest* ← last stage Multiplier result  
 Advance 3-Stage M pipeline one stage  
 M pipeline first stage ← *fsrc1* × *fsrc2*

**pform** *fsrc1, fdest* ..... **Pipelined OR to MERGE Register**  
*fdest* ← last stage Graphics result  
 last stage Graphics result ← *fsrc1* OR MERGE  
 MERGE ← 0

**pfsm.p** *fsrc1, fsrc2, fdest* ..... **Pipelined Floating-Point Subtract and Multiply**  
*fdest* ← last stage Adder result  
 Advance A and M pipeline one stage (operands accessed before advancing pipeline)  
 A pipeline first stage ← A-op1 – A-op2  
 M pipeline first stage ← M-op1 × M-op2

**pfsub.p** *fsrc1, fsrc2, fdest* ..... **Pipelined Floating-Point Subtract**  
*fdest* ← last stage Adder result  
 Advance A pipeline one stage  
 A pipeline first stage ← *fsrc1* + *fsrc2*

**pftrunc.v** *fsrc1, fdest* ..... **Pipelined Floating-Point to Integer Conversion**  
*fdest* ← last stage Adder result  
 Advance A pipeline one stage  
 A pipeline first stage ← 64-bit value with low-order 32 bits  
 equal to integer part of *fsrc1*

**pfzchkl** *fsrc1, fsrc2, fdest* ..... **Pipelined 32-Bit Z-Buffer Check**  
 Consider *fsrc1*, *fsrc2*, and *fdest*, as arrays of two 32-bit  
 fields *fsrc1*(0)..*fsrc1*(1), *fsrc2*(0)..*fsrc2*(1), and *fdest*(0)..*fdest*(1)  
 where zero denotes the least significant field.  
 PM ← PM shifted right by 2 bits  
 FOR *i* = 0 to 1  
 DO  
 PM [*i* + 6] ← *fsrc2*(*i*) ≤ *fsrc1*(*i*) (unsigned)  
*fdest*(*i*) ← last stage Graphics result  
 last stage Graphics result ← smaller of *fsrc2*(*i*) and *fsrc1*(*i*)  
 OD  
 MERGE ← 0

**pfzchks** *fsrc1, fsrc2, fdest* ..... **Pipelined 16-Bit Z-Buffer Check**  
 Consider *fsrc1*, *fsrc2*, and *fdest*, as arrays of four 16-bit  
 fields *fsrc1*(0)..*fsrc1*(3), *fsrc2*(0)..*fsrc2*(3), and *fdest*(0)..*fdest*(3)  
 where zero denotes the least significant field.  
 PM ← PM shifted right by 4 bits  
 FOR *i* = 0 to 3  
 DO  
 PM [*i* + 4] ← *fsrc2*(*i*) ≤ *fsrc1*(*i*) (unsigned)  
*fdest*(*i*) ← last stage Graphics result  
 last stage Graphics result ← smaller of *fsrc2*(*i*) and *fsrc1*(*i*)  
 OD  
 MERGE ← 0

**pst.d** *fdest, #const(isrc2)* ..... **Pixel Store**  
**pst.d** *fdest, #const(isrc2) +* ..... **Pixel Store Autoincrement**  
 Pixels enabled by PM in mem.d (*isrc2* + #*const*) ← *fdest*  
 Shift PM right by 8/pixel size (in bytes) bits  
 IF autoincrement  
 THEN *isrc2* ← #*const* + *isrc2*  
 FI

**shi** *isrc1, isrc2, idest* ..... **Shift Left**  
*idest* ← *isrc2* shifted left by *isrc1* bits



|               |   |                           |
|---------------|---|---------------------------|
| <b>shr</b>    | <i>isrc1, isrc2, idest</i> .....  | Shift Right               |
|               | SC (in <i>psr</i> ) ← <i>isrc1</i><br><i>idest</i> ← <i>isrc2</i> shifted right by <i>isrc1</i> bits  |                           |
| <b>shra</b>   | <i>isrc1, isrc2, idest</i> .....  | Shift Right Arithmetic    |
|               | <i>idest</i> ← <i>isrc2</i> arithmetically shifted right by <i>isrc1</i> bits   |                           |
| <b>shrd</b>   | <i>isrc1, isrc2, idest</i> .....  | Shift Right Double        |
|               | <i>idest</i> ← low-order 32 bits of <i>isrc1:isrc2</i> shifted right by SC bits   |                           |
| <b>st.c</b>   | <i>isrc1ni, csrc2</i> .....   | Store to Control Register |
|               | <i>csrc2</i> ← <i>isrc1ni</i>   |                           |
| <b>st.x</b>   | <i>isrc1ni, #const(isrc2)</i> .....   | Store Integer             |
|               | <i>mem.x(isrc2 + #const)</i> ← <i>isrc1ni</i>   |                           |
| <b>subs</b>   | <i>isrc1, isrc2, idest</i> .....  | Subtract Signed           |
|               | <i>idest</i> ← <i>isrc1 - isrc2</i><br>OF ← (bit 31 carry ≠ bit 30 carry)<br>CC set if <i>isrc2</i> > <i>isrc1</i> (signed)<br>CC clear if <i>isrc2</i> ≤ <i>isrc1</i> (signed)                     |                           |
| <b>subu</b>   | <i>isrc1, isrc2, idest</i> .....  | Subtract Unsigned         |
|               | <i>idest</i> ← <i>isrc1 - isrc2</i><br>OF ← NOT (bit 31 carry)<br>CC ← bit 31 carry<br>(i.e. CC set if <i>isrc2</i> ≤ <i>isrc1</i> (unsigned)<br>CC clear if <i>isrc2</i> > <i>isrc1</i> (unsigned) |                           |
| <b>trap</b>   | <i>isrc1ni, isrc2, idest</i> .....  | Software Trap             |
|               | Generate trap with IT set in <i>psr</i>   |                           |
| <b>unlock</b> | .....   | End Interlocked Sequence  |
|               | Clear BL in <i>dirbase</i> . The next load or store unlocks the bus.<br>Enable interrupts after bus is unlocked.  |                           |
| <b>xor</b>    | <i>isrc1, isrc2, idest</i> .....  | Logical Exclusive OR      |
|               | <i>idest</i> ← <i>isrc1 XOR isrc2</i><br>CC set if result is zero, cleared otherwise  |                           |
| <b>xorh</b>   | <i>#const, isrc2, idest</i> .....   | Logical Exclusive OR High |
|               | <i>idest</i> ← ( <i>#const</i> shifted left 16 bit) XOR <i>isrc2</i><br>CC set if result is zero, cleared otherwise   |                           |

Table 7.2 FADDP MERGE Update

| Pixel Size (from PS) | Fields Loaded From Result into MERGE | Right Shift Amount (Field Size) |
|----------------------|--------------------------------------|---------------------------------|
| 8                    | 63..56, 47..40, 31..24, 15..8        | 8                               |
| 16                   | 63..58, 47..42, 31..26, 15..10       | 6                               |
| 32                   | 63..56, 31..24                       | 8                               |

## 7.2 Instruction Format and Encoding

All instructions are one word long and begin on a word boundary. When operands are registers, the register encodings shown in Table 7.3 are used. There are two general core-instruction formats, REG-format and CTRL-format, as well as a separate format for floating-point instructions.

### 7.2.1 REG-FORMAT INSTRUCTIONS

Within the REG-format are several variations as shown in Figure 7.1. Table 7.4 gives the encodings for these instructions. One encoding is an escape code that defines yet another variation: the core escape instructions. Figure 7.2 shows the format of this group, and Table 7.5 shows the encodings.

In these instructions, the *src2* field selects one of the 32 integer registers (most instructions) or five control registers (**st.c** and **ld.c**). *Dest* selects one of the 32 integer registers (most instructions) or float-

ing-point registers (**fld**, **fst**, **pfld**, **pst**, **ixfr**). For instructions where *src1* is optionally an immediate value, bit 26 of the opcode (I-bit) indicates whether *src1* is an immediate. If bit 26 is clear, an integer register is used; if bit 26 is set, *src1* is contained in the low-order 16 bits, except for **bte** and **btne** instructions. For **bte** and **btne**, the five-bit immediate value is contained in the *src1* field. For **st**, **bte**, **btne** and **bla**, the upper five bits of the *offset* or *broffset* are contained in the *dest* field instead of *src1*, and the lower 11 bits of *offset* are the lower 11 bits of the instruction.

Table 7.3 Register Encoding

| Register                | Encoding |
|-------------------------|----------|
| r0                      | 0        |
| .                       | .        |
| .                       | .        |
| r31                     | 31       |
| f0                      | 0        |
| .                       | .        |
| .                       | .        |
| f31                     | 31       |
| Fault Instruction       | 0        |
| Processor Status        | 1        |
| Directory Base          | 2        |
| Data Breakpoint         | 3        |
| Floating-Point Status   | 4        |
| Extended Process Status | 5        |



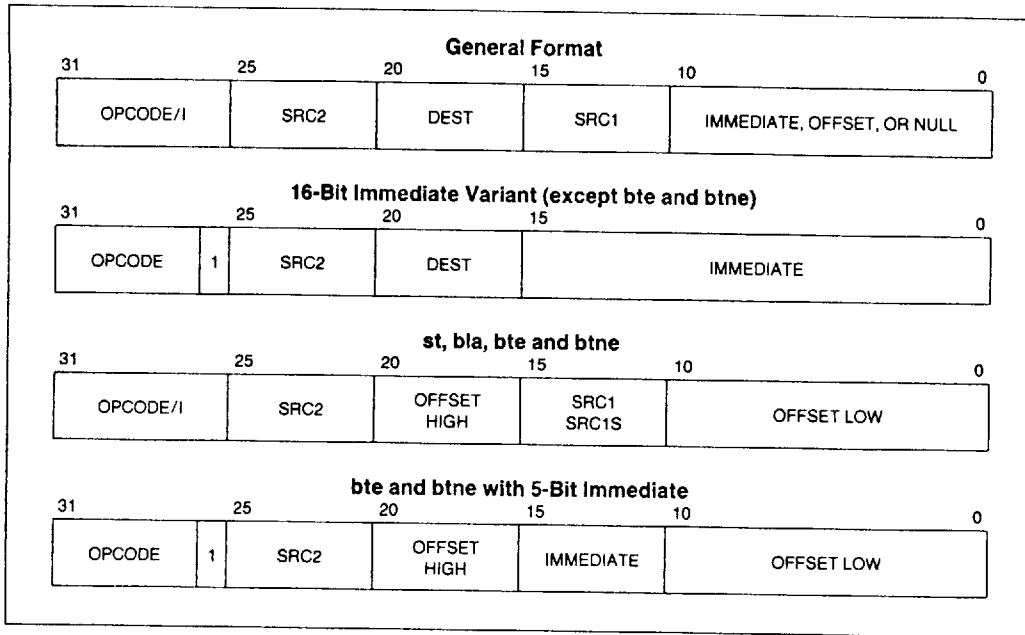

Figure 7.1 REG-Format Variations

For **ld** and **st**, bits 28 and zero determine operand size as follows:

| Bit 28 | Bit 0 | Operand Size |
|--------|-------|--------------|
| 0      | 0     | 8-bits       |
| 0      | 1     | 8-bits       |
| 1      | 0     | 16-bits      |
| 1      | 1     | 32-bits      |

When *src1* is an immediate and bit 28 is set, bit zero of the immediate value is forced to zero.

For **fld**, **fst**, **pfld**, **pst** and **flush**, bit 0 selects autoincrement addressing if set. Bits one and two select the operand size as follows:

| Bit 1 | Bit 2 | Operand Size |
|-------|-------|--------------|
| 0     | 0     | 64-bits      |
| 0     | 1     | 128-bits     |
| 1     | 0     | 32-bits      |
| 1     | 1     | 32-bits      |

When *src1* is an immediate value, bits zero and one of the immediate value are forced to zero to maintain alignment. When bit one of the immediate value is clear, bit two is also forced to zero.

For **flush**, bits one and two must be zero.

**Table 7.4 REG-Format Opcodes**

|                            |  | 31 |   |   |    | 26 |   |  |
|----------------------------|--|----|---|---|----|----|---|--|
| <b>ld.x</b>                | Load Integer                                     | 0  | 0 | 0 | L  | 0  | I |  |
| <b>st.x</b>                | Store Integer                                    | 0  | 0 | 0 | L  | 1  | I |  |
| <b>ixfr</b>                | Integer to F-P Reg Transfer<br>(reserved)        | 0  | 0 | 0 | 0  | 1  | 0 |  |
| <b>fld.x, fst.x</b>        | Load/Store F-P                                   | 0  | 0 | 1 | 0  | LS | I |  |
| <b>flush</b>               | Flush  | 0  | 0 | 1 | 1  | 0  | 1 |  |
| <b>pst.d</b>               | Pixel Store                                      | 0  | 0 | 1 | 1  | 1  | 1 |  |
| <b>ld.c, st.c</b>          | Load/Store Control Register                      | 0  | 0 | 1 | 1  | LS | 0 |  |
| <b>bri</b>                 | Branch Indirect                                  | 0  | 1 | 0 | 0  | 0  | 0 |  |
| <b>trap</b>                | Trap<br>(Escape for F-P Unit)                    | 0  | 1 | 0 | 0  | 0  | 1 |  |
|                            | (Escape for Core Unit)                           | 0  | 1 | 0 | 0  | 1  | 1 |  |
| <b>bte, btne</b>           | Branch Equal or Not Equal                        | 0  | 1 | 0 | 1  | E  | I |  |
| <b>pfld.y</b>              | Pipelined F-P Load<br>(CTRL-Format Instructions) | 0  | 1 | 1 | 0  | 0  | I |  |
| <b>addu, -s, subu, -s,</b> | Add/Subtract                                     | 1  | 0 | 0 | SO | AS | I |  |
| <b>shl, shr</b>            | Logical Shift                                    | 1  | 0 | 1 | 0  | LR | I |  |
| <b>shrd</b>                | Double Shift                                     | 1  | 0 | 1 | 1  | 0  | 0 |  |
| <b>bla</b>                 | Branch LCC Set and Add                           | 1  | 0 | 1 | 1  | 0  | 1 |  |
| <b>shra</b>                | Arithmetic Shift                                 | 1  | 0 | 1 | 1  | 1  | I |  |
| <b>and(h)</b>              | AND  | 1  | 1 | 0 | 0  | H  | I |  |
| <b>andnot(h)</b>           | ANDNOT   | 1  | 1 | 0 | 1  | H  | I |  |
| <b>or(h)</b>               | OR   | 1  | 1 | 1 | 0  | H  | I |  |
| <b>xor(h)</b>              | XOR  | 1  | 1 | 1 | 1  | H  | I |  |
|                            | (reserved)                                       | 1  | 1 | x | x  | 1  | 0 |  |

- L** Integer Length  
 0 —8 bits  
 1 —16 or 32 bits (selected by bit 0)
- LS** Load/Store  
 0 —Load  
 1 —Store
- SO** Signed/Ordinal  
 0 —Ordinal  
 1 —Signed
- H** High  
 0 —and, or, andnot, xor  
 1 —andh, orh, andnoth, xorh

- AS** Add/Subtract  
 0 —Add  
 1 —Subtract
- LR** Left/Right  
 0 —Left Shift  
 1 —Right Shift
- E** Equal  
 0 —Branch on Not Equal  
 1 —Branch on Equal
- I** Immediate  
 0 —src1 is register  
 1 —src1 is immediate



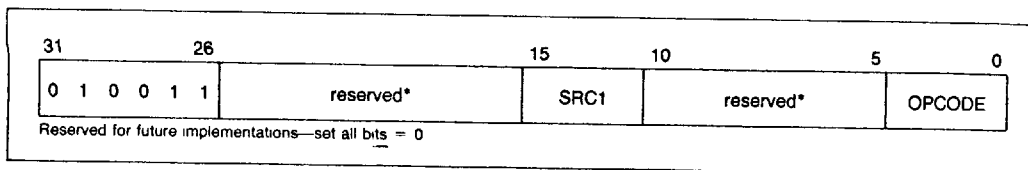

Figure 7.2 Core Escape Instruction Format

Table 7.5 Core Escape Opcodes

|               |                            | 4 | 0 |
|---------------|----------------------------|---|---|
|               | (reserved)                 | 0 | 0 |
| <b>lock</b>   | Begin Interlocked Sequence | 0 | 1 |
| <b>calll</b>  | Indirect Subroutine Call   | 0 | 0 |
|               | (reserved)                 | 0 | 1 |
| <b>intovr</b> | Trap on Integer Overflow   | 0 | 0 |
|               | (reserved)                 | 0 | 1 |
|               | (reserved)                 | 0 | 1 |
| <b>unlock</b> | End Interlocked Sequence   | 0 | 1 |
|               | (reserved)                 | 0 | x |
|               | (reserved)                 | 1 | x |
|               | (reserved)                 | 1 | x |

7.2.2 CTRL-FORMAT INSTRUCTIONS

The CTRL instructions do not refer to registers, so instead of the register fields, they have a 26-bit relative branch offset. Figure 7.3 shows the format of these instructions and Table 7.6 defines the encodings.

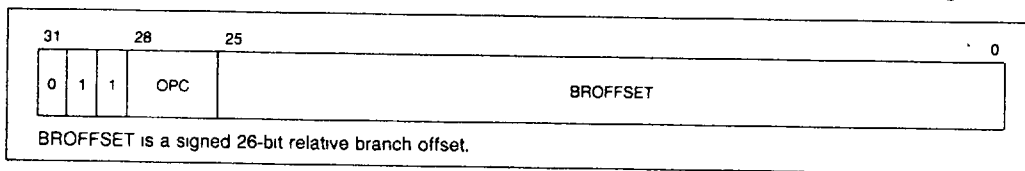

Figure 7.3 CTRL Instruction Format

Table 7.6 CTRL-Format Opcodes

|                |                    | 28 | 26 |
|----------------|--------------------|----|----|
|                | (reserved)         | 0  | 0  |
|                | (reserved)         | 0  | 1  |
| <b>br</b>      | Branch Direct      | 0  | 0  |
| <b>call</b>    | Call               | 0  | 1  |
| <b>bc(.t)</b>  | Branch on CC Set   | 1  | T  |
| <b>bnc(.t)</b> | Branch on CC Clear | 1  | T  |

T Taken  
 0 —bc or bnc  
 1 —bc.t or bnc.t





The following table shows the opcode mnemonics that generate the various encodings of DPC and explains each encoding.

Table 7.8 DPC Encoding

| DPC  | PFAM Mnemonic | PFSM Mnemonic | M-Unit op1 | M-Unit op2 | A-Unit op1 | A-Unit op2 | T Load | K Load* |
|------|---------------|---------------|------------|------------|------------|------------|--------|---------|
| 0000 | r2p1          | r2s1          | KR         | src2       | src1       | M result   | No     | No      |
| 0001 | r2pt          | r2st          | KR         | src2       | T          | M result   | No     | Yes     |
| 0010 | r2ap1         | r2as1         | KR         | src2       | src1       | A result   | Yes    | No      |
| 0011 | r2apt         | r2ast         | KR         | src2       | T          | A result   | Yes    | Yes     |
| 0100 | i2p1          | i2s1          | KI         | src2       | src1       | M result   | No     | No      |
| 0101 | i2pt          | i2st          | KI         | src2       | T          | M result   | No     | Yes     |
| 0110 | i2ap1         | i2as1         | KI         | src2       | src1       | A result   | Yes    | No      |
| 0111 | i2apt         | i2ast         | KI         | src2       | T          | A result   | Yes    | Yes     |
| 1000 | rat1p2        | rat1s2        | KR         | A result   | src1       | src2       | Yes    | No      |
| 1001 | m12apm        | m12asm        | src1       | src2       | A result   | M result   | No     | No      |
| 1010 | ra1p2         | ra1s2         | KR         | A result   | src1       | src2       | No     | No      |
| 1011 | m12t1pa       | m12t1sa       | src1       | src2       | T          | A result   | Yes    | No      |
| 1100 | iat1p2        | iat1s2        | KI         | A result   | src1       | src2       | Yes    | No      |
| 1101 | m12tpm        | m12t1sm       | src1       | src2       | T          | M result   | No     | No      |
| 1110 | ia1p2         | ia1s2         | KI         | A result   | src1       | src2       | No     | No      |
| 1111 | m12t1pa       | m12t1sa       | src1       | src2       | T          | A result   | No     | No      |

| DPC  | PFMAM Mnemonic | PFMSM Mnemonic | M-Unit op1 | M-Unit op2 | A-Unit op1 | A-Unit op2 | T Load | K Load* |
|------|----------------|----------------|------------|------------|------------|------------|--------|---------|
| 0000 | mr2p1          | mr2s1          | KR         | src2       | src1       | M result   | No     | No      |
| 0001 | mr2pt          | mr2st          | KR         | src2       | T          | M result   | No     | Yes     |
| 0010 | mr2mp1         | mr2ms1         | KR         | src2       | src1       | M result   | Yes    | No      |
| 0011 | mr2mpt         | mr2mst         | KR         | src2       | T          | M result   | Yes    | Yes     |
| 0100 | mi2p1          | mi2s1          | KI         | src2       | src1       | M result   | No     | No      |
| 0101 | mi2pt          | mi2st          | KI         | src2       | T          | M result   | No     | Yes     |
| 0110 | mi2mp1         | mi2ms1         | KI         | src2       | src1       | M result   | Yes    | No      |
| 0111 | mi2mpt         | mi2mst         | KI         | src2       | T          | M result   | Yes    | Yes     |
| 1000 | mrmt1p2        | mrmt1s2        | KR         | M result   | src1       | src2       | Yes    | No      |
| 1001 | mm12mpm        | mm12msm        | src1       | src2       | M result   | M result   | No     | No      |
| 1010 | mrm1p2         | mrm1s2         | KR         | M result   | src1       | src2       | No     | No      |
| 1011 | mm12t1pm       | mm12t1sm       | src1       | src2       | T          | A result   | Yes    | No      |
| 1100 | mimt1p2        | mimt1s2        | KI         | M result   | src1       | src2       | Yes    | No      |
| 1101 | mm12t1pm       | mm12t1sm       | src1       | src2       | T          | M result   | No     | No      |
| 1110 | mim1p2         | mim1s2         | KI         | M result   | src1       | src2       | No     | No      |
| 1111 |                |                |            |            |            |            |        |         |

Intel-Reserved

\*If K-load is set, KR is loaded when operand-1 of the multiplier is KR; KI is loaded when operand-1 of the multiplier is KI.



### 7.3 Instruction Timings

Military i860 XR microprocessor instructions take one clock to execute unless a freeze condition is invoked. Freeze conditions and their associated de-

lays are shown in the table below. Freezes due to multiple simultaneous cache misses result in a delay that is the sum of the delays for processing each miss by itself. Other multiple freeze conditions usually add only the delay of the longest individual freeze.

| Freeze Condition   | Delay   |
|--|---|
| Instruction-cache miss.  | Number of clocks to read instruction (from $\overline{ADS}$ clock to first $\overline{READY}$ clock) plus time to last $\overline{READY}$ of block when jump or freeze occurs during miss processing plus two clocks if data-cache being accessed when instruction-cache miss occurs. |
| Reference to destination of <b>ld</b> instruction that misses.   | One plus number of clocks to read data (from $\overline{ADS}$ clock to first $\overline{READY}$ clock) minus number of instructions executed since load (not counting instruction that references load destination).  |
| <b>fld</b> miss.   | One plus number of clocks until first $\overline{READY}$ returned (for 32- or 64-bit read cycles) or until second $\overline{READY}$ returned (for 128-bit <b>fld.q</b> read cycles).   |
| <b>call/calli/ixfr/ixfr/ld.c/st.c</b> and data cache miss processing in progress.  | One plus number of clocks until first $\overline{READY}$ returned (for 64-bit read cycles) or until second $\overline{READY}$ returned (for 128-bit <b>fld.q</b> read cycles).  |
| <b>ld/st/pfld/fld/fst</b> and data cache miss processing in progress.  | One plus number of clocks until last $\overline{READY}$ returned.   |
| Reference to <i>dest</i> of <b>ld</b> , <b>call</b> , <b>calli</b> , <b>ixfr</b> or <b>ld.c</b> in the next instruction. ( <i>Dest</i> of <b>call</b> and <b>calli</b> is r1.) | One clock.  |



PRELIMINARY



| Freeze Condition   | Delay   |
|--|---|
| Reference to <i>dest</i> of <b>fld/pfld/ixfr</b> in the next two instructions  | Two clocks in the first instruction; one in the second instruction  |
| <b>bc/bnc/bc.t/bnc.t</b> following <b>fadd/fsub/pfeg/pfgt</b>  | One clock   |
| <i>Src1</i> of multiplier operation refers to result of previous operation   | One clock   |
| Floating-point or graphics unit instruction or <b>fst</b> , and scalar operation in progress other than <b>frcp</b> or <b>frsqr</b>  | If the scalar operation is <b>fadd, fix, fmlow, fmul.ss, fmul.sd, ftrunc</b> or <b>fsub</b> , two minus the number of instructions (or dual-mode pairs) already executed after the scalar operation. If the scalar operation is <b>fmul.dd</b> , three minus the number of instructions (or dual-mode pairs) executed after it. Add one if either or both of these two situations occur: <ol style="list-style-type: none"> <li>1. There is an overlap between the result register of the previous scalar operation and the source of the floating-point operation, and the destination precision of the scalar operation is different than the source precision of the floating-point operation.</li> <li>2. The floating-point operation is pipelined and its destination is not <b>f0</b>.</li> </ol> There is no delay if the result is negative. |
| Multiplier operation preceded by a double-precision multiply   | One clock   |
| Multiplier operation with data pattern requiring extra rounding operation  | One clock   |
| TLB miss   | Five plus the number of clocks to finish two reads plus the number of clocks to set A-bits (if necessary)   |
| <b>pfld</b> when three <b>pfld</b> 's are outstanding  | One plus the number of clocks to return data from first <b>pfld</b>   |
| <b>pfld</b> hits in the data cache   | Two plus the number of clocks to finish all outstanding accesses  |
| <b>st, pst</b> or <b>fst</b> miss <b>ld</b> miss, or <b>flush</b> with modified block when store path full (two stores or one 256-bit write-back internally waiting for bus plus external bus pipeline full) | One plus the number of clocks until <b>READY</b> active on next 64-bit write cycle or second <b>READY</b> of next 128-bit write cycle.  |
| <b>ld, fld, pfld, st, pst</b> or <b>fst</b> when address path full (one address internally waiting for bus plus external bus pipeline full)  | Number of clocks until next nonrepeated address can be issued (i.e., an address that is not the 2nd–4th cycle of a cache fill, the 2nd–8th cycle of a CS8 mode instruction fetch, nor the 2nd cycle of a 128-bit write).  |
| <b>ld/fld</b> following <b>st/fst</b> hit  | One clock   |
| Delayed branch not taken   | One clock   |

| Freeze Condition  | Delay   |
|---|---|
| Nondelayed branch taken:<br><b>bc, bnc</b><br><b>bte, btne</b>  | One clock<br>Two clocks   |
| Indirect branch <b>bri</b> or call <b>calli</b><br><b>st.c</b>  | One clock<br>Two clocks   |
| Result of graphics-unit instruction (other than <b>fmov.dd</b> ) used in next instruction when the next instruction is an adder- or multiplier-unit instruction | One clock   |
| Result of graphics-unit instruction used in next instruction when the next instruction is a graphics-unit instruction   | One clock   |
| <b>flush</b> followed by <b>flush</b>   | Three clocks minus the number of instructions between the two <b>flush</b> instructions. There is no delay if the result is negative. |
| <b>fst</b> or <b>pst</b> followed by pipelined floating-point operation that overwrites the register being stored   | One clock   |



PRELIMINARY

## 7.4 Instruction Characteristics

The following table lists some of the characteristics of each instruction. The characteristics are:

- What processing unit executes the instruction. The codes for processing units are:
  - A Floating-point adder unit
  - E Core execution unit
  - G Graphics unit
  - M Floating-point multiplier unit
- Whether the instruction is pipelined or not. *P* indicates that the instruction is pipelined.
- Whether the instruction is a delayed branch instruction. *D* marks the delayed branches.
- Whether the instruction changes the condition code *CC*. *CC* marks those instructions that change *CC*.
- Which faults can be caused by the instruction. The codes used for exceptions are.
  - IT Instruction Fault
  - SE Floating-Point Source Exception
  - RE Floating-Point Result Exception, including overflow, underflow, inexact result
  - DAT Data Access Fault

Note that this is not the same as specifying at which instructions faults may be reported. A result exception is reported on the subsequent floating-point instruction, **pst**, **fst** or sometimes **fld**, **pfld** and **ixfr**

The instruction access fault IAT and the interrupt trap IN are not shown in the table because they can occur for any instruction.

- Performance notes. These comments regarding optimum performance are recommendations only. If these recommendations are not followed, the Military i860 XR microprocessor automatically waits the necessary number of clocks to satisfy internal hardware requirements. The following notes define the numeric codes that appear in the instruction table:
  - 1 The following instruction should not be a conditional branch (**bc**, **bnc**, **bc.t** or **bnc.t**).
  - 2 The destination should not be a source operand of the next two instructions.

3. A load should not directly follow a store that is expected to hit in the data cache.
  4. When the prior instruction is scalar, *fsrc1* should not be the same as the *fdest* of the prior operation.
  5. The *fdest* should not reference the destination of the next instruction if that instruction is a pipelined floating-point operation.
  6. The destination should not be a source operand of the next instruction. (For **call** and **calli**, the destination is **r1**.)
  7. When the prior operation is scalar and multiplier *op1* is *src1*, *src2* should not be the same as the *rdest* of the prior operation.
  8. When the prior operation is scalar, *fsrc1* and *fsrc2* of the current operation should not be the same as *fdest* of the prior operation.
  9. A **pfld** should not immediately follow a **pfld**.
- Programming restrictions. These indicate combinations of conditions that must be avoided by programmers, assemblers and compilers. The following notes define the alphabetic codes that appear in the instruction table:
    - a. The sequential instruction following a delayed control-transfer instruction may not be another control-transfer instruction (except in the case of external interrupts), nor a trap instruction, nor the target of a control-transfer instruction.
    - b. When using a **bri** to return from a trap handler, programmers should take care to prevent traps from occurring on that or on the next sequential instruction. *IM* should be zero (interrupts disabled) when the **bri** is executed.
    - c. If *fdest* is not zero, *fsrc1* must not be the same as *fdest*.
    - d. When *fsrc1* goes to the multiplier *op1*, *KR*, or *KI*, *fsrc1* must not be the same as *fdest*.
    - e. If *fdest* is not zero, *fsrc1* and *fsrc2* must not be the same as *fdest*.
    - f. *isrc1* must not be the same as *isrc2* for the autoincrementing form of this instruction.
    - g. *isrc1* must not be the same as *isrc2*.

Table 7.9 Instruction Characteristics

| Instruction                                     | Execution Unit        | Pipelined? Delayed? | Sets CC?                   | Faults                            | Performance Notes | Programming Restrictions |
|---|-----------------------|---------------------|----------------------------|-----------------------------------|-------------------|--------------------------|
| adds<br>addu<br>and<br>andh<br>andnot           | E<br>E<br>E<br>E<br>E |                     | CC<br>CC<br>CC<br>CC<br>CC |                                   | 1<br>1            |                          |
| andnoth<br>bc<br>bc.t<br>bla<br>bnc             | E<br>E<br>E<br>E<br>E | D<br>D              | CC                         |                                   |                   | a<br>a, g                |
| bnc.t<br>br<br>bri<br>bte<br>btne               | E<br>E<br>E<br>E<br>E | D<br>D<br>D         |                            |                                   |                   | a<br>a<br>a, b           |
| call<br>calli<br>fadd.p<br>faddp<br>faddz       | E<br>E<br>A<br>G<br>G | D<br>D              |                            | SE, RE                            | 6<br>6<br>8<br>8  | a<br>a                   |
| famov.r<br>fiadd.z<br>fisub.z<br>fix.p<br>fld.y | A<br>G<br>G<br>A<br>E |                     |                            | SE, RE<br>SE, RE<br>DAT           | 8<br>8<br>2, 3    | f                        |
| flush<br>fmlow.p<br>fmul.p<br>form<br>frep.p    | E<br>M<br>M<br>G<br>M |                     |                            | SE, RE<br>SE, RE                  | 4<br>4<br>8       |                          |
| frsqr.p<br>fst.y<br>fsub.p<br>ftrunc.v<br>fxfr  | M<br>E<br>A<br>A<br>G |                     |                            | SE, RE<br>DAT<br>SE, RE<br>SE, RE | 5<br>6, 8         | f                        |
| fzchkl<br>fzchks<br>intovr<br>ixfr<br>ld.c      | G<br>G<br>E<br>E<br>E |                     |                            | IT                                | 8<br>8<br>2       |                          |
| ld.x<br>or<br>orh<br>pfadd.p<br>pfaddp          | E<br>E<br>E<br>A<br>G | P<br>P              | CC<br>CC                   | DAT<br>SE, RE                     | 6<br>8            | e                        |





| Instruction | Execution Unit | Pipelined? Delayed? | Sets CC? | Faults | Performance Notes | Programming Restrictions |
|-------------|----------------|---------------------|----------|--------|-------------------|--------------------------|
| pfaddz      | G              | P                   |          |        | 8                 | e                        |
| pfam.p      | A&M            | P                   |          | SE, RE | 7                 | d                        |
| pfamov.r    | A              | P                   |          | SE, RE |                   |                          |
| pfreq.p     | A              | P                   | CC       | SE     | 1                 |                          |
| pfgt.p      | A              | P                   | CC       | SE     | 1                 |                          |
| pfiaadd.z   | G              | P                   |          |        | 8                 | e                        |
| pfisub.z    | G              | P                   |          |        | 8                 | e                        |
| pfix.p      | A              | P                   |          | SE, RE |                   |                          |
| pfid.z      | E              | P                   |          | DAT    | 2, 9              | f                        |
| pfmam.p     | A & M          | P                   |          | SE, RE | 7                 | d                        |
| pfmsm.p     | A & M          | P                   |          | SE, RE | 7                 | d                        |
| pfmul.p     | M              | P                   |          | SE, RE | 4                 | c                        |
| pfmul3.dd   | M              | P                   |          | SE, RE | 4                 | c                        |
| pform       | G              | P                   |          |        | 8                 | e                        |
| pfsm.p      | A&M            | P                   |          | SE, RE | 7                 | d                        |
| pfsub.p     | A              | P                   |          | SE, RE |                   |                          |
| pftrunc.v   | A              | P                   |          | SE, RE |                   |                          |
| pfzchkl     | G              | P                   |          |        | 8                 |                          |
| pfzchks     | G              | P                   |          |        | 8                 |                          |
| pst.d       | E              |                     |          | DAT    |                   | f                        |
| shl         | E              |                     |          |        |                   |                          |
| shr         | E              |                     |          |        |                   |                          |
| shra        | E              |                     |          |        |                   |                          |
| shrd        | E              |                     |          |        |                   |                          |
| st.c        | E              |                     |          |        |                   |                          |
| st.x        | E              |                     |          | DAT    |                   |                          |
| subs        | E              |                     | CC       |        | 1                 |                          |
| subu        | E              |                     | CC       |        | 1                 |                          |
| trap        | E              |                     |          | IT     |                   |                          |
| xor         | E              |                     | CC       |        |                   |                          |
| xorh        | E              |                     | CC       |        |                   |                          |



## DOMESTIC SERVICE OFFICES

### ALABAMA

\*Intel Corp.  
5015 Bradford Dr., Suite 2  
Huntsville 35805  
Tel: (205) 830-4010

### ALASKA

Intel Corp.  
c/o TransAlaska Data Systems  
300 Old Steese Hwy.  
Fairbanks 99701-3120  
Tel: (907) 452-4401

Intel Corp.  
c/o TransAlaska Data Systems  
1551 Lore Road  
Anchorage 99507  
Tel: (907) 522-1776

### ARIZONA

\*Intel Corp.  
1125 N. 28th Dr.  
Suite D-214  
Phoenix 85029  
Tel: (602) 869-4980

\*Intel Corp.  
500 E. Fry Blvd., Suite M-15  
Sierra Vista 85635  
Tel: (602) 459-5010

### CALIFORNIA

†Intel Corp.  
21515 Vanowen St., Ste. 116  
Canoga Park 91303  
Tel: (818) 704-8500

\*Intel Corp.  
2250 E. Imperial Hwy., Ste. 218  
El Segundo 90245  
Tel: (213) 640-6040

\*Intel Corp.  
1900 Pralite City Rd.  
Folsom 95630-8597  
Tel: (916) 351-6143  
1-800-468-3548

Intel Corp.  
9665 Cheasapeake Dr., Suite 325  
San Diego 92123-1326  
Tel: (619) 292-8086

\*\*Intel Corp.  
400 N. Tuslin Avenue  
Suite 450  
Santa Ana 92705  
Tel: (714) 835-9642

\*\*Intel Corp.  
San Tomas 4  
2700 San Tomas Exp., 2nd Floor  
Santa Clara 95051  
Tel: (408) 986-8086

### COLORADO

\*Intel Corp.  
630 S. Cherry St., Suite 915  
Denver 80222  
Tel: (303) 321-8086

### CONNECTICUT

\*Intel Corp.  
301 Lee Farm Corporate Park  
83 Wooster Heights Rd.  
Danbury 06810  
Tel: (203) 748-3130

### FLORIDA

\*\*Intel Corp.  
6363 N.W. 6th Way, Ste. 100  
Ft. Lauderdale 33309  
Tel: (305) 771-0600

\*Intel Corp.  
5850 T.G. Lee Blvd., Ste. 340  
Orlando 32822  
Tel: (407) 240-8000

### GEORGIA

\*Intel Corp.  
3280 Pointe Pkwy., Ste. 200  
Norcross 30092  
Tel: (404) 449-0541

### HAWAII

\*Intel Corp.  
U.S.I.S.C. Signal Batt.  
Building T-1521  
Shafter Plaza  
Shafter 96856

### ILLINOIS

\*\*Intel Corp.  
300 N. Martingale Rd., Ste. 400  
Schaumburg 60173  
Tel: (312) 605-8031

### INDIANA

\*Intel Corp.  
8777 Purdue Rd., Ste. 125  
Indianapolis 46268  
Tel: (317) 875-0623

### KANSAS

\*Intel Corp.  
10985 Cody, Suite 140  
Overland Park 66210  
Tel: (913) 945-2727

### MARYLAND

\*\*Intel Corp.  
10010 Junction Dr., Suite 200  
Annapolis Junction 20701  
Tel: (301) 206-2860  
FAX: 301-206-3677

### MASSACHUSETTS

\*\*Intel Corp.  
3 Carlisle Rd., 2nd Floor  
Westford 01886  
Tel: (508) 692-1060

### MICHIGAN

\*Intel Corp.  
7071 Orchard Lake Rd., Ste. 100  
West Bloomfield 48322  
Tel: (313) 851-8905

### MINNESOTA

\*Intel Corp.  
3500 W. 60th St., Suite 360  
Bloomington 55431  
Tel: (612) 835-6722

### MISSOURI

\*Intel Corp.  
4203 Earth City Exp., Ste. 131  
Earth City 63045  
Tel: (314) 291-1990

### NEW JERSEY

\*\*Intel Corp.  
300 Sylvan Avenue  
Englewood Cliffs 07632  
Tel: (201) 567-0821

\*Intel Corp.  
Parkway 109 Office Center  
328 Newman Springs Road  
Red Bank 07701  
Tel: (201) 747-2233

\*Intel Corp.  
280 Corporate Center  
75 Livingston Ave., 1st Floor  
Roseland 07068  
Tel: (201) 740-0111

### NEW YORK

\*Intel Corp.  
2950 Expressway Dr. South  
Islandia 11722  
Tel: (516) 231-3300

\*Intel Corp.  
Westage Business Center  
Bldg. 300, Route 9  
Fishkill 12524  
Tel: (914) 897-8960

### NORTH CAROLINA

\*Intel Corp.  
5800 Executive Dr., Ste. 105  
Charlotte 28212  
Tel: (704) 568-8966

\*\*Intel Corp.  
2700 Wycliff Road  
Suite 102  
Raleigh 27607  
Tel: (919) 781-8022

### OHIO

\*\*Intel Corp.  
3401 Park Center Dr., Ste. 220  
Dayton 45414  
Tel: (513) 890-5350

\*Intel Corp.  
25700 Science Park Dr., Ste. 100  
Beachwood 44122  
Tel: (216) 464-2736

### OREGON

Intel Corp.  
15254 N.W. Greenbrier Parkway  
Building B  
Beaverton 97005  
Tel: (503) 645-8051

\*Intel Corp.  
5200 N.E. Elam Young Parkway  
Hillsboro 97123  
Tel: (503) 681-8080

### PENNSYLVANIA

\*Intel Corp.  
455 Pennsylvania Ave., Ste. 230  
Fort Washington 19034  
Tel: (215) 641-1000

†Intel Corp.  
400 Penn Center Blvd., Ste. 610  
Pittsburgh 15235  
Tel: (412) 823-4970

Intel Corp.  
1513 Cedar Cliff Dr.  
Camp Hill 17011  
Tel: (717) 761-0860

### PUERTO RICO

Intel Corp.  
South Industrial Park  
P.O. Box 910  
Las Piedras 00671  
Tel: (809) 733-8616

### TEXAS

Intel Corp.  
8815 Dyer St., Suite 225  
El Paso 79904  
Tel: (915) 751-0186

\*Intel Corp.  
313 E. Anderson Lane, Suite 314  
Austin 78752  
Tel: (512) 454-3628

\*\*Intel Corp.  
12000 Ford Rd., Suite 401  
Dallas 75234  
Tel: (214) 241-8087

\*Intel Corp.  
7322 S.W. Freeway, Ste. 1490  
Houston 77074  
Tel: (713) 988-8086

### UTAH

Intel Corp.  
428 East 6400 South, Ste. 104  
Murray 84107  
Tel: (801) 263-8051

### VIRGINIA

\*Intel Corp.  
1504 Santa Rosa Rd., Ste. 108  
Richmond 23288  
Tel: (804) 282-5688

### WASHINGTON

\*Intel Corp.  
155 108th Avenue N.E., Ste. 386  
Bellevue 98004  
Tel: (206) 453-8086

### CANADA

ONTARIO  
Intel Semiconductor of  
Canada, Ltd.  
2650 Queensview Dr., Ste. 250  
Ottawa K2B 8H6  
Tel: (613) 829-9714  
FAX: 613-820-5936

Intel Semiconductor of  
Canada, Ltd.  
180 Alwell Dr., Ste. 102  
Rexdale M9W 6H8  
Tel: (416) 675-2105  
FAX: 416-675-2438

## CUSTOMER TRAINING CENTERS

### CALIFORNIA

2700 San Tomas Expressway  
Santa Clara 95051  
Tel: (408) 970-1700  
1-800-421-0386

### ILLINOIS

300 N. Martingale Road  
Suite 303  
Schaumburg 60173  
Tel: (708) 708-5700  
1-800-421-0386

### MASSACHUSETTS

3 Carlisle Road, First Floor  
Westford 01886  
Tel: (301) 220-3380  
1-800-328-0386

### MARYLAND

10010 Junction Dr.  
Suite 200  
Annapolis Junction 20701  
Tel: (301) 206-2860  
1-800-328-0386

## SYSTEMS ENGINEERING MANAGERS OFFICES

### MINNESOTA

3500 W. 80th Street  
Suite 360  
Bloomington 55431  
Tel: (612) 835-6722

### NEW YORK

2950 Expressway Dr., South  
Islandia 11722  
Tel: (508) 231-3300

†System Engineering locations

\*Carry-in locations

\*\*Carry-in/mail-in locations

CG/SALE/101789